

POLITEKNIK

SULTAN SALAHUDDIN ABDUL AZIZ SHAH

BLOOD PRESSURE WITH IOT

**NAME: MUHAMMAD AQIL
BIN JUMRI**

**REGISTRATION
NO
08DEU20F2023**

JABATAN KEJURUTERAAN ELEKTRIK

NOVEMBER 2021

IOT BLOOD PRESSURE

NAME: MUHAMMAD AQIL BIN JUMRI **REGISTRATION NO** 08DEU20F2023

This report submitted to the Electrical Engineering Department in fulfillment of the requirement for a Diploma in Electrical Engineering

JABATAN KEJURUTERAAN ELEKTRIK

NOVEMBER 2022

CONFIRMATION OF THE PROJECT

The project report titled "IOT BLOOD PRESSURE" has been submitted, reviewed and verified as a fulfills the conditions and requirements of the Project Writing as stipulated

Checked by:

Supervisor's name : Puan Siti Hajar binti Abdul Hamid

Supervisor's signature:

Date :

Verified by:

Project Coordinator name :

Signature of Coordinator :

Date :

“I acknowledge this work is my own work except the excerpts I have already explained to our source”

1. Signature : 

Name : **MUHAMMAD AQIL BIN JUMRI**

Registration Number : **08DEU20F2023**

Date :

DECLARATION OF ORIGINALITY AND OWNERSHIP

TITLE : WIRELESS BLOOD PRESSURE

SESSION: SESI 1 2021/2022

1. I, **1.** Click here to enter text.

is a final year student of **Diploma in Electrical Engineering, Department of Electrical, Politeknik Sultan Salahuddin Abdul Aziz Shah**, which is located at **Persiaran Usahawan, 40150 Shah Alam, Selangor.**

- 2. I acknowledge that 'The Project above' and the intellectual property therein is the result of our original creation /creations without taking or impersonating any intellectual property from the other parties.
- 3. I agree to release the 'Project' intellectual property to 'The Polytechnics' to meet the requirements for awarding the **Diploma in Electrical Engineering** to me.

Made and in truth that is recognized by;

a) Click here to enter text.)
(Identification card No: - Click here to enter text.))
Click here to enter text.

In front of me, Click here to enter text. (Click here)
to enter text.))
Click here to enter text.
As a project supervisor, on the date:

ACKNOWLEDGEMENTS

Assalamualaikum W.B.T

Alhamdulillah our gratitude to be towards Illahi with His grace I can complete our project successfully.

I am heartily thankful to my supervisor, Puan Siti Hajar , whose encouragement, guidance and support from the initial to the initial to the final level enabled I to develop an understanding of the subject.

I also like to acknowledge, especially for all the lecturer at the Department Electrical Engineering Polytechnic Sultan Sallahudin Abdul Aziz Shah for their trust in us to provide a project can have proud. Thank you for giving guidance, encouragement and assistance to us.

Particularly well for my family to the spirit, encouragement and financial help for I to produce something new in the electronics market and provide this proposal. Not to forget for all our friends who have helped us in producing this project report.

ABSTRACT

Blood pressure is very important nowadays because it is a tool to measure blood pressure. At the same time, this wireless blood pressure can measure the pulse. This tool is easy to use, just put the "cuff" on the wrist. Machines that measure blood pressure on the market today do not have a feature that allows users to save blood pressure data directly through a smartphone. With the availability of this blood pressure IOT, a feature is added to store data from the blood pressure machine into the smartphone. The size of this blood pressure machine is compact and easy to carry anywhere.

ABSTRAK

Blood pressure ini sangat penting pada masa kini kerana ia merupakan satu alat untuk mengukur tekanan darah . Dalam masa yang sama blood pressure ini dapat mengukur nadi. Alat ini hanya mudah digunakan hanya perlu memasukan cuff ke pergelangan tangan . Mesin yang mengukur tekanan darah yang ada di pasaran sekarang ini tidak mempunyai ciri ciri yang membolehkan pengguna menyimpan data tekanan darah terus melalui telefon pintar . Dengan adanya IOT blood pressure ini ditambah ciri untuk menyimpan data data dari mesin tekanan darah itu ke dalam telefon pintar. Saiz mesin tekanan darah tanpa wayar ini adalah kecil dan mudah dibawa ke mana mana ..

TABLE OF CONTENTS

CONFIRMATION OF THE PROJECT	i
DECLARATION OF ORIGINALITY AND OWNERSHIP	iii
ACKNOWLEDGEMENTS	iv
ABSTRACT	v
ABSTRAK	vi
TABLE OF CONTENTS	vii
LIST OF TABLES	Error! Bookmark not defined.
LIST OF FIGURES	Error! Bookmark not defined.
LIST OF SYMBOLS	Error! Bookmark not defined.
LIST OF ABBREVIATIONS	Error! Bookmark not defined.
CHAPTER 1	1
1 INTRODUCTION	1
1.1 Introduction	1
1.2 Background Research	1
1.3 Problem Statement	2
1.4 Research Objectives	3
1.5 Scope of Research	3
1.6 Project Significance	3
CHAPTER 2	5
2 LITERATURE REVIEW	5
2.1 Introduction	5
2.2 The Circulatory System	Error! Bookmark not defined.
2.2.1 Blood Circulation	
2.3 Method to Measure Blood Pressure	10
2.3.1 Invasive Method	
2.3.2 The Auscultatory Method	
2.3.3 Oscillometric Method	
CHAPTER 3	14
3 RESEARCH METHODOLOGY	14
3.1 Introduction	14
3.2 Design	
3.2.1 Block Diagram of the Project	14
3.2.2 Flowchart of the Project 2	15
3.3 Project Hardware	16
3.3.1 Schematic Circuit	17
3.3.2 Description of Main Component (PPG)	
3.3.2.1 Amplifier	
3.3.2.2 Bluetooth	
3.3.2.3 LCD	
3.4 Project Software	20
3.4.1 Flowchart of the System	21
3.4.2 Description of Flowchart	21
	vii

3.5	Prototype Development	22
CHAPTER 4		23
4	PROJECT MANAGEMENT AND COSTING	41
4.1	Introduction	41
4.2	Result and Analysis	42
4.3	Discussion	Error! Bookmark not defined.
REFERENCES		Error! Bookmark not defined.
5	APPENDICES	Error! Bookmark not defined.
	APPENDIX A- DATA SHEET	Error! Bookmark not defined.
	APPENDIX B- PROGRAMMING	Error! Bookmark not defined.
	APPENDIX C- PROJECT MANUAL/PRODUCT CATALOGUE	Error! Bookmark not defined.
	defined.	
CHAPTER 6		Error! Bookmark not defined.
6	<u>PROJECT MANAGEMENT AND COSTING</u>	Error! Bookmark not defined.
6.1	<u>Introduction</u>	Error! Bookmark not defined.
6.2	<u>Gant Chart and Activities of the Project</u>	Error! Bookmark not defined.
6.3	<u>Milestone</u>	Error! Bookmark not defined.
6.4	<u>Cost and Budgeting</u>	Error! Bookmark not defined.
6.5	<u>Chapter Summary</u>	Error! Bookmark not defined.

CHAPTER 1

INTRODUCTION

1.1 Introduction

Blood pressure gauge, is a device used to measure blood pressure, composed of an inflatable cuff to collapse and then release the artery under the cuff in a controlled manner, and a mercury or aneroid manometer to measure the pressure. Manual sphygmomanometers are used with a stethoscope when using the auscultatory technique.

A sphygmomanometer consists of an inflatable cuff, a measuring unit (the mercury manometer, or aneroid gauge), and a mechanism for inflation which may be a manually operated bulb and valve or a pump operated electrically.

Wireless blood pressure is very important nowadays because it is a tool to measure blood pressure. At the same time, this wireless blood pressure can measure the pulse. This tool is easy to use, just put the "cuff" on the wrist. Machines that measure blood pressure on the market today do not have a feature that allows users to save blood pressure data directly through a smartphone. With the availability of this wireless blood pressure IOT, a feature is added to store data from the blood pressure machine into the smartphone. The size of this wireless blood pressure machine is small and easy to carry anywhere. This machine also comes with a cordless.

1.2 Background Research

Johns Hopkins researchers and clinicians continue to explore ways to prevent and manage high blood pressure and its effects. Among their noteworthy research:

Antihypertensive drugs may help preserve cognitive function in people with high blood pressure. Johns Hopkins researchers led a study showing that hypertension in midlife raises the odds of memory problems in old age. When treated early, though, this risk may drop.

Higher weight and weight gain raises the risk of high blood pressure. This is especially true from young adulthood through midlife. A Johns Hopkins study helped to solidify the link between high body mass index and high blood pressure.

1.3 Problem Statement

Blood pressure is very important to measure for the older person who are diagnosed with Hypertension (high blood pressure), as they typically need frequent monitoring. Regarding the blood pressure monitoring, users would typically take a reading once a week to prevent the hypertension or any disease.

Besides that , traditional medical devices used in hospital are often bulky and expensive, only operating by specially trained nurses and not suitable for self monitoring. Hence, there is a need of portable, low cost devices that can be easily operated by ordinary people to detect physiological parameters like blood pressure for self monitoring at home. By using the project me build , they can keep their data to their smartphone.

1.4 Research Objectives

1. The main objective of this Project is To develop non invasive continuous blood pressure monitoring that portable and easy to operated by ordinary people.

More specifically the principle objective of this research are:

1. To design a blood pressure
2. To implement
3. To develop the ordinary blood pressure into a blood pressure that could save data into smartphone.

1.5 Scope of Research

The purpose of this project is to monitor the blood pressure. In this project, photoplethysmographic (PPG) sensor place at finger used to estimate blood pressure. The non-invasive auscultatory and oscillometric measurements are simpler and quicker than invasive measurements, require less expertise, have virtually no complications, are less unpleasant and less painful for the patient . This project focuses on the patient who that suffered with hypertension disease.

In this project the suggestion method that is a continuous blood pressure monitoring.. This project used the laptop as a main device, so the user can be used anytime, anywhere and anyone. This project consist 2 parts, which is hardware and software. For the hardware, photoplethysmographic (PPG) sensor are use to estimate blood pressure. Besides that, for the software, arduino are using to displays the measured blood pressure information to laptop and transmits them through a wireless.

1.6 Project Significance

The significant of this project is to facilitate self monitoring for the patient who has the hypertension disease. The increase in blood pressure or hypertension is one of the factors that significantly raise the rate of morbidity and mortality in developed countries. Some factor to motivate this project is growing percentage of aging population, and chronic diseases caused by lifestyle changes, leading to the need for constantly measuring the health status of individuals.

It is an essential parameter for the diagnosis and treatment. Daily monitoring of blood pressure is also important to prevent the cardiovascular disease among normal people. Besides that, this project gives information to user for awareness of low blood pressure and high blood pressure.

CHAPTER 2

LITERATURE REVIEW

1.7 Introduction

This chapter reviews related literature from the existing research of the blood pressure, where the blood pressure measurement using a several method. Other than that, this chapter also covered the circulatory system, hypertension disease, whitecoat hypertension disease and hypotension.

1.8 The Circulatory System

The human heart pumps bloods through the arteries, which connect to smaller arterioles and then even smaller capillaries. The capillaries are thin walled vessels interconnect with the smallest arteries and smallest veins. Blood flow throughout the body begin its return to the heart when the capillaries return blood to the venules and then to the veins. The cardiovascular systems therefore consist of a closed circuit the heart, arteries, arterioles, capillaries, venules, and vein. It provides oxygen and nutrients to tissues while removing waste. The heart is located within mediastinum, resting on diaphragm. The heart divided into two artia and two ventricles. Blood low in oxygen and high in carbon dioxide enters the right side of the heart and is pumped into the pulmonary circulation. The left ventricle pumps blood out of the heart to the rest of the body.

The figure below show the Circulatory system.

Commented [FAP1]: This section contains the introduction of this chapter. Briefly tell the reader what are the important matters will be reviewed during the project/research development.

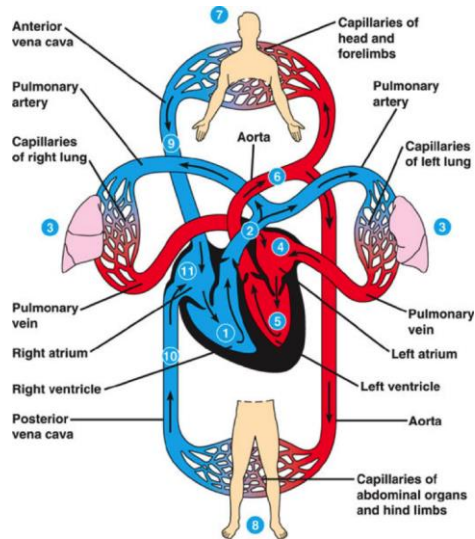

Figure 2.1: The Circulatory System

1.8.1 Blood Circulation

Blood enters the pulmonary circuit from the right ventricle through the pulmonary trunk, which extends upward posterior from the heart. It divides into right and left pulmonary arteries, which enter the right and left lungs, respectively. Repeated divisions connect to arterioles and capillary network associated with the walls of the alveoli, where gas exchange between blood and air occurs. The pulmonary capillaries lead to venules and then vein. Four pulmonary veins, two for each lung, return blood to the left atrium, completing the vascular loop of the pulmonary circuit.

The systemic circuit involves the movement of freshly oxygenated blood from the left atrium to left ventricle, then into the aorta and its branches, leading to all body tissues. Eventually it makes its way to the companion vein system that return blood to the right atrium.

1.8.2 Blood Pressure

Blood pressure, the amount of force applied on the walls of the arteries when the blood is forced throughout the body, depends on factors such as the amount of blood in the body, the pumping rate of the heart, the flexibility of the arterial walls, and the resistance to blood flow due to the size of the arteries. The blood pressure of a human varies continuously due to physical activity, medication, anxiety, and emotions. The body has unique mechanisms to regulate a person's blood flow; whenever a person's blood pressure drops, the heart rate increases to pump more blood and the arterial walls contract to increase the blood pressure. The reading of blood pressure will be affected by body position, temperature, surrounding, emotion and disease.

Blood pressure that is pathologically low is called hypotension, and pressure that is pathologically high is hypertension. Both have many causes and can range from mild to severe, with both acute and chronic forms.

Hypotension can cause the blood supply to the brain, heart and other tissues to be too low and hypertension is strongly correlated with higher risk for cerebral stroke and heart infarct. [3] Figure above show the blood pressure in the blood vessel

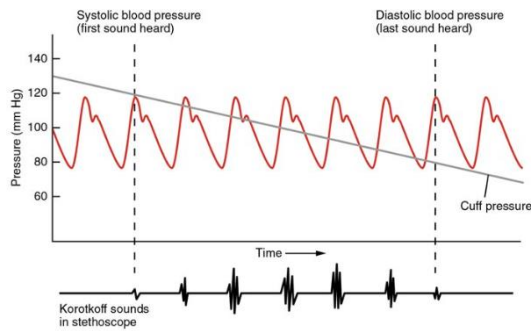

Figure 2.2 : Blood Pressure and Velocity

Normal resting systolic (diastolic) blood pressure in an adult is approximately 120 mmHg (80 mmHg), abbreviated "120/80 mmHg". Blood Pressure Measure = Systolic Pressure over Diastolic Pressure. The table below show the blood pressure stages.

Blood Pressure Stages

Blood Pressure Category	Systolic mm Hg (upper #)		Diastolic mm Hg (lower #)
Normal	less than 120	and	less than 80
Elevated	120-129	and	less than 80
High Blood Pressure (Hypertension) Stage 1	130-139	or	80-89
High Blood Pressure (Hypertension) Stage 2	140 or higher	or	90 or higher
Hypertensive Crisis (Seek Emergency Care)	higher than 180	and/or	higher than 120

Table 2.1 : Blood Pressure Stages

2.2.3.2 Hypertension

High blood pressure is a common condition in which the long-term force of the blood against your artery walls is high enough that it may eventually cause health problems, such as heart disease. Hypertension is a major risk factor for ischaemic and haemorrhagic stroke, myocardial infarction, heart failure, chronic kidney disease, cognitive decline and premature death. Untreated hypertension is usually associated with a progressive rise in blood pressure. The vascular and renal damage that this may cause can culminate in a treatment-resistant state.

High blood pressure is defined as a systolic bloodpressure at or above 140 mmHg and/or a diastolic blood pressure at or above 90 mmHg. Systolic blood pressure is the maximum pressure in the arteries when the heart contracts. Diastolic blood pressure is the minimum pressure in the arteries between the heart's contractions. High blood pressure causes the heart to have to work harder to push blood throughout the body. This stresses the body's blood vessels, causing them to stiffen, clog or weaken [12].

2.

1.9 Method to Measure Blood Pressure

3. To get the reading of blood pressure there are several method which is invasive method, auscultatory method , oscillometric technique , ultrasound techniques and lastly volume clamping method of Penaz

1.9.1 Invasive Method

Invasive (intra-arterial) blood pressure (IBP) monitoring is a commonly used technique in the Intensive Care Unit (ICU) and is also often used in the operating theatre. The technique involves the insertion of a catheter into a suitable artery and then displaying the measured pressure wave on a monitor. The most common reason for using intra-arterial blood pressure monitoring is to gain a 'beat-to-beat' record of a patient's blood pressure.

Continuous 'beat-to-beat' blood pressure monitoring is useful in patients who are likely to display sudden changes in blood pressure (e.g. vascular surgery), in whom close control of blood pressure is required (e.g. head injured patients), or in patients receiving drugs to maintain the blood pressure (e.g. patients receiving inotropes such as epinephrine). The technique allows accurate blood pressure readings at low pressures, for example in shocked patients. Figure below show the invasive method of blood pressure.

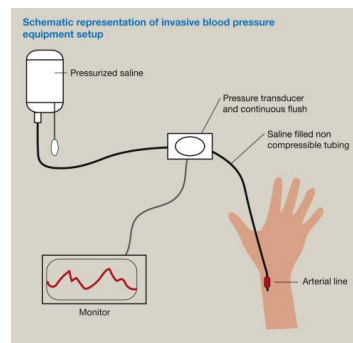

Figure 2.3 Invasive Method

1.9.2 The Auscultatory Method

Although the auscultatory method using mercury sphygmomanometer is regarded as the gold standard for office blood pressure measurement, widespread implementation of the ban in use of mercury sphygmomanometers continues to diminish the role of this technique. The situation is made worse by the fact that existing aneroid manometers, which use this technique, are less accurate and often need frequent calibration. New devices known as "hybrid" sphygmomanometers have been developed as replacement for mercury devices. Basically these devices combine the features of both electronic and auscultatory devices such that the mercury column is replaced by an electronic pressure gauge, similar to oscillometric devices, but the blood pressure is taken in the same manner as a mercury or aneroid device, by an observer using a stethoscope and listening for the Korotkoff sounds. Figure below show the auscultatory method of non invasive blood pressure.

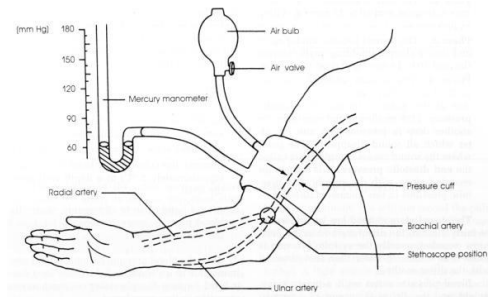

Figure 2.4 : Auscultatory Method

1.9.3 Oscillometric Method

This was first demonstrated by Marey and it was subsequently shown that when the oscillations of pressure in a sphygmomanometer cuff are recorded during gradual deflation, the point of maximal oscillation corresponds to the mean intra-arterial pressure. The oscillations begin at approximately systolic pressure and continue below diastolic so that systolic and diastolic pressure can only be estimated indirectly according to some empirically derived algorithm. This method is advantageous in that no transducer need be placed over the brachial artery, and it is less susceptible to external noise (but not to low frequency mechanical vibration), and that the cuff can be removed and replaced by the patient during ambulatory monitoring. For example, to take a shower. The main disadvantage is that such recorders do not work well during physical activity when there may be considerable movement artifact. The oscillometric technique has been used successfully in ambulatory blood pressure monitors and home monitors. It should be pointed out that different brands of oscillometric recorders use different algorithms, and there is no generic oscillometric

technique. Figure below show the oscillometric method of non invasive blood pressure.

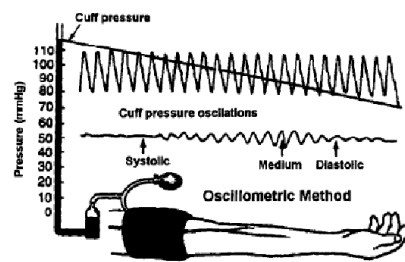

Figure 2.5 : Oscillometric Method

1.9.4 The Finger Cuff Method of Penaz

This interesting method was first developed by Penaz and works on the principle of the "unloaded arterial wall." Arterial pulsation in a finger is detected by a photoplethysmograph under a pressure cuff. The output of the plethysmograph is used to drive a servo-loop, which rapidly changes the cuff pressure to keep the output constant, so that the artery is held in a partially opened state. The oscillations of pressure in the cuff are measured and have been found to resemble the intra-arterial pressure wave in most subjects. This method gives an accurate estimate of the changes of systolic and diastolic pressure when compared to brachial artery pressures the cuff can be kept inflated for up to 2 hours. It is now commercially available as the Finometer and Portapres recorders and has been validated in several studies against intra-arterial pressures[17]. Figure below show the finger cuff method.

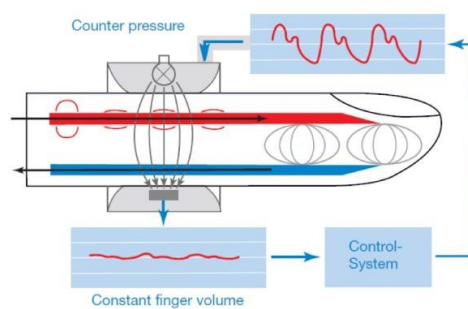

Figure 2.6 : Finger Cuff Method

1.9.5 Tonometry Method

First presented by Pressman & Newgard in 1963, the arterial tonometer is a pressure Measurement method that can noninvasively and continuously record pressure alterations in a superficial artery with sufficient bony support, such as the radial artery. It uses a miniature transducer or a rigid sensor array or a flexible diaphragm, which is attached on the skin above the pulsating artery. Skin and tissue located between the sensor and the artery transfer pressure pulsations between them. When the pulsations reach their strongest level, the sensor is regarded as being correctly positioned. This can be facilitated by using a sensor array and selecting sensor elements with the strongest amplitude. This method requires that the sensors are closely alike in terms of sensitivity.

Next, the sensor or sensor array is pushed towards the vessel using, for example, air pressure. The vessel flattens when the pressure and, consequently, the force against the artery wall increases. Arterial pressure in the top of the flattened artery's center equals the supporting pressure, allowing the recording of an accurate blood pressure profile. If the pressure increases too much, the artery will occlude totally and the measurement will be erroneous. When the tonometer is attached on the skin over a superficial artery, such as the radial artery, blood pressure pulsations in it produce volume shifts inside the volume sensor resulting in an impedance change. The pressure inside the tonometer can be varied so that the strongest signal can be measured. This pressure corresponds to mean arterial pressure, MAP.[18] Figure below show the tonometry method of blood pressure method

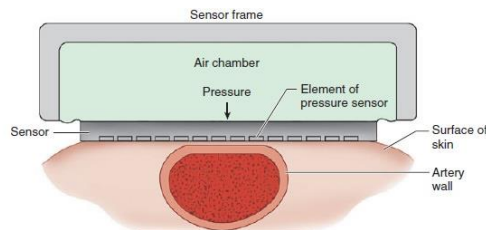

Figure 2.7 : Tonometry Method

- 4.
- 5.

CHAPTER 3

RESEARCH METHODOLOGY

1.10 Introduction

This chapter will cover about the process and the method that used to make this project. Methodology plays an important role in executing the continuous blood pressure estimation. In this chapters, there will be covered to section which is software and hardware.

1.11 Design

This project will consist 2 parts which is hardware and software. This hardware consist Photoplethymographic (PPG) sensor used to estimate the blood pressure from the subject, amplifier used to amplify the signal that gets from the PPG Sensor. Last part for hardware is used arduino to control the circuit and Espresso Life used to transfer data from the circuit to the Laptop.

1.11.1 Block Diagram of the Project

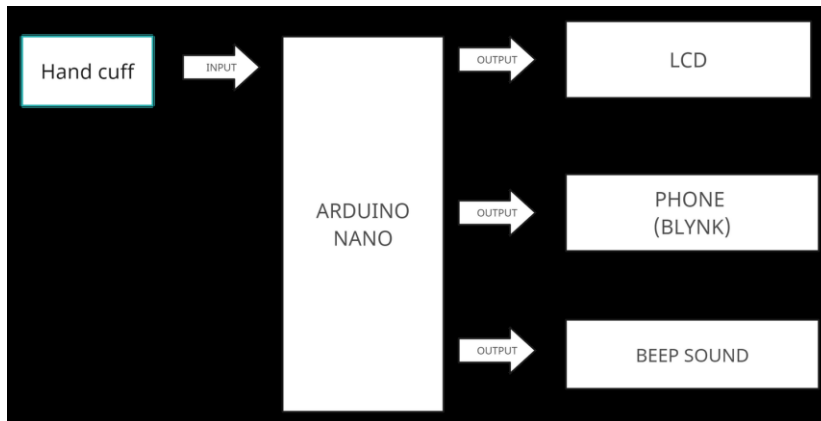

1.11.2 Flowchart of the Project 2

This project consist 2 flowcharts which is flow chart of overall project and the second is flow chart of continuous blood pressure. This flow chart will explain the flow or step during do this project.

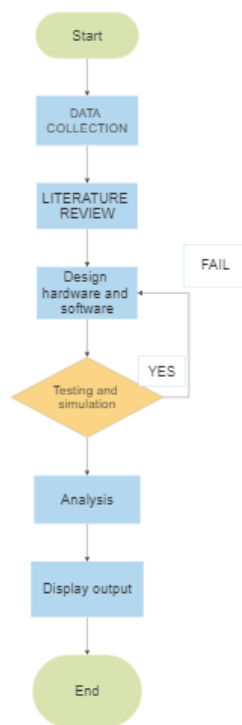

Figure 3.1 : Flowchart of overall project

Flow chart above show how these projects implement. At the first, data collection are collected to recognize the problem statement, objective, scope of project and significant of project. After identify the chapter 1, literature reviews are important to enhance the knowledge about this project. The sources for this literature review are from the journals and articles. After that, designation hardware and software should be discussed with supervisor. After get the endorsement about what a design should be to this project, the testing and simulation will be run to get a data. If fail, recheck back at the software and hardware, if success proceed to the data analysis and display the result.

1.12 Project Hardware

In this project, the hardware has been used is PPG Sensor, amplifier , LCD and Bluetooth

1.12.1 Schematic Circuit

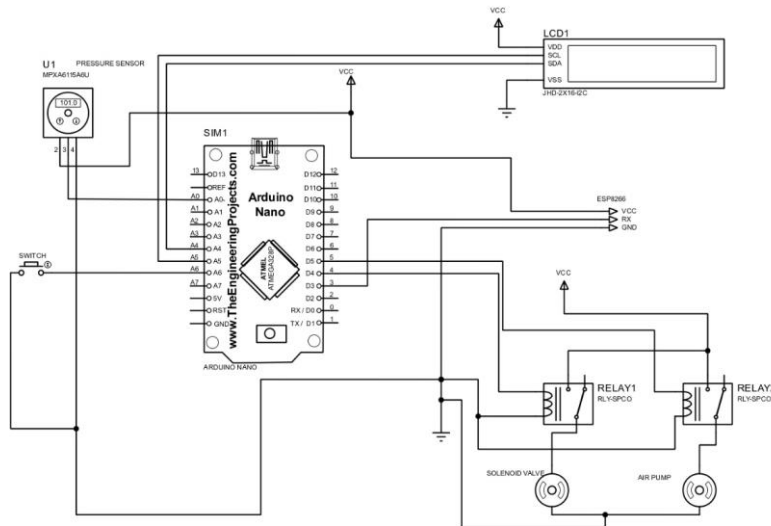

Figure 3.2 : Schematic Circuit

1.12.2 Photoplethysmographic (PPG Sensor)

The figure below show the Photoplethysmography Sensor. Photoplethysmography (PPG) is a simple optical technique used to detect volumetric changes in blood in peripheral circulation. It is a low cost and noninvasive method that makes measurements at the surface of the skin. The technique provides valuable information related to our cardiovascular system. Recent advances in technology has revived interest in this technique, which is widely used in clinical physiological measurement and monitoring.

PPG makes uses of lowintensity infrared (IR) light. When light travels through biological tissues it is absorbed by bones, skin pigments and both venous and arterial blood. Since light is more strongly absorbed by blood than the surrounding tissues, the changes in blood flow can be detected by PPG sensors as changes in the intensity of light. The voltage signal from PPG is proportional to the quantity of blood flowing through the blood vessels.

Even small changes in blood volume can be detected using this method, though it cannot be used to quantify the amount of blood. A PPG signal has several components including volumetric changes in arterial blood which is associated with cardiac activity, variations in venous blood volume which modulates the PPG signal,

a DC component showing the tissues optical property and subtle energy changes in the body. Some major factors affecting the recordings from the PPG are site of measurement and the contact force

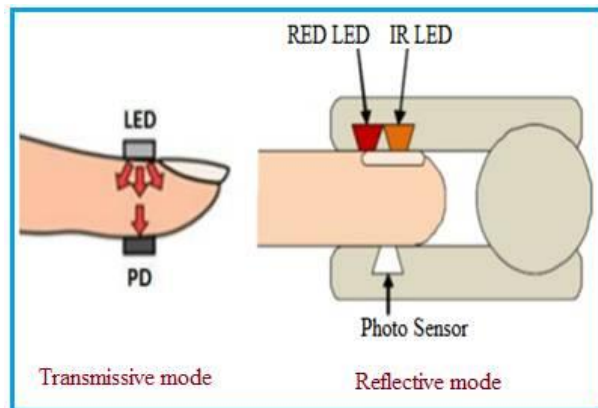

Figure 3.3 : PPG Sensor

1.12.2.1 Amplifier

The figure below shows the symbol of amplifier. An amplifier is used to increase the amplitude of a signal waveform, without changing other parameters of the waveform such as frequency or wave shape. They are one of the most commonly used circuits in electronics and perform a variety of functions in a great many electronic systems. They can be categorized as either weak-signal amplifiers or power amplifiers.

Weak-signal amplifiers are used primarily in wireless receivers. They are also employed in acoustic pickups, audio tape players, and compact disc players. A weak-signal amplifier is designed to deal with exceedingly small input signals, in some cases measuring only a few nanovolts (units of 10^9 volt).

Such amplifiers must generate minimal internal noise while increasing the signal voltage by a large factor. The most effective device for this application is the field-effect transistor. The specification that denotes the effectiveness of a weak-signal amplifier is sensitivity, defined as the number of microvolt (units of 10 volt) of signal input that produce a certain ratio of signal output to noise output (usually 10 to 1).

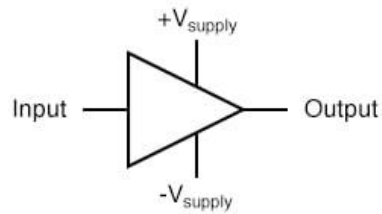

Figure 3.4 : Symbol of Amplifier

1.12.2.2 Bluetooth

Figure below show the symbol of Bluetooth. Bluetooth is a standard used in links of radio of short scope, destined to replace wired connections between electronic devices like cellular telephones, Personal Digital Assistants (PDA), computers, and many other devices. Bluetooth technology can be used at home, in the office, in the car, etc. This technology allows to the users instantaneous connections of voice and information between several devices in real time. The way of transmission used assures protection against interferences and safety in the sending of information.

Between the principal characteristics, must be named the hardiness, low complexity, low consume and low cost. The Bluetooth is a small microchip that operates in a band of available frequency throughout the world. Communications can realize point to point and point multipoint.



Figure 3.5 : Bluetooth

1.12.2.3 LCD

LCD (liquid crystal display) is the technology used for displays in notebook and other smaller computers. Like light-emitting diode (LED) and gas-plasma

technologies, LCDs allow displays to be much thinner than cathode ray tube (CRT) technology.

Liquid crystal display technology works by blocking light. Specifically, an LCD is made of two pieces of polarized glass (also called substrate) that contain a liquid crystal material between them. A backlight creates light that passes through the first substrate. At the same time, electrical currents cause

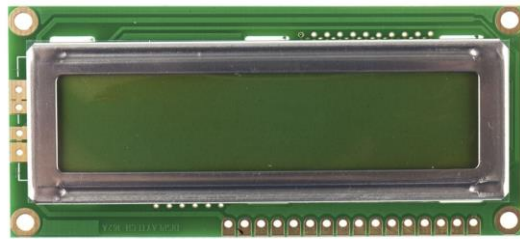
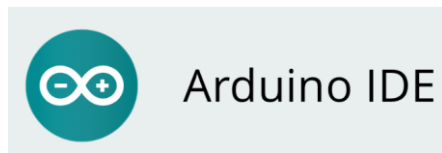
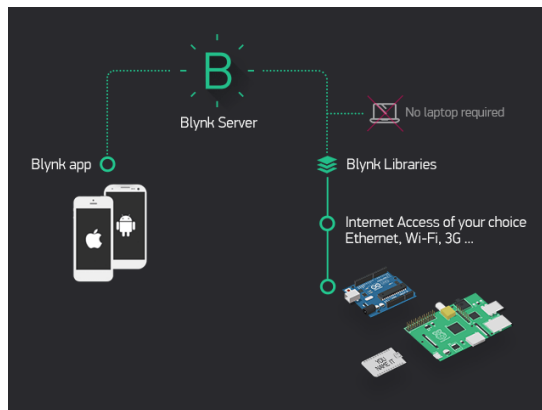

Figure 3.6 : LCD

1.13 Project Software

The software has been used in this project is Blynk and Arduino IDE. This software is used to give instruction or to control the circuit and to get the reading while to display the output.



1.13.1 Flowchart of the System

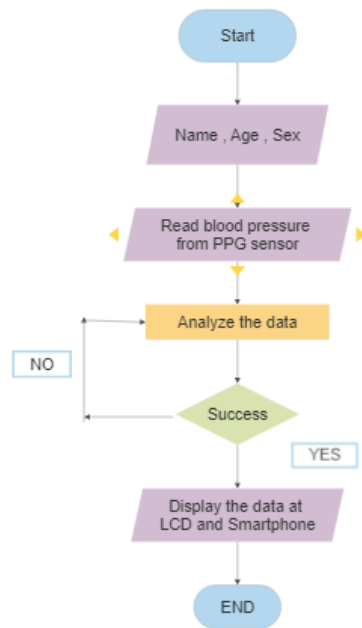

Figure 3.7 : Flowchart of the system

1.13.2 Description of Flowchart

Flow chart above show how this continuous blood pressure works. First, the data of subject will insert to the laptop. After that, the PPG Sensor will read the continuous blood pressure from finger. After PPG read the continuous blood pressure from finger data will be analyze and display at the smartphone.

1.14 Prototype Development

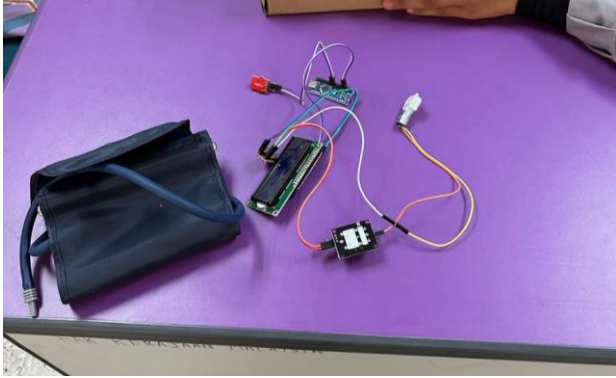

Figure 3.8 : Prototype

CHAPTER 4

RESULTS AND DISCUSSION

4.1 Introduction

In this chapter, the matters about the technical information of the project and the results will be discussed. From data collection and data analyzed and generated graph and value by using Blynk .

4.2 Results and Analysis

Patient 1 experiment

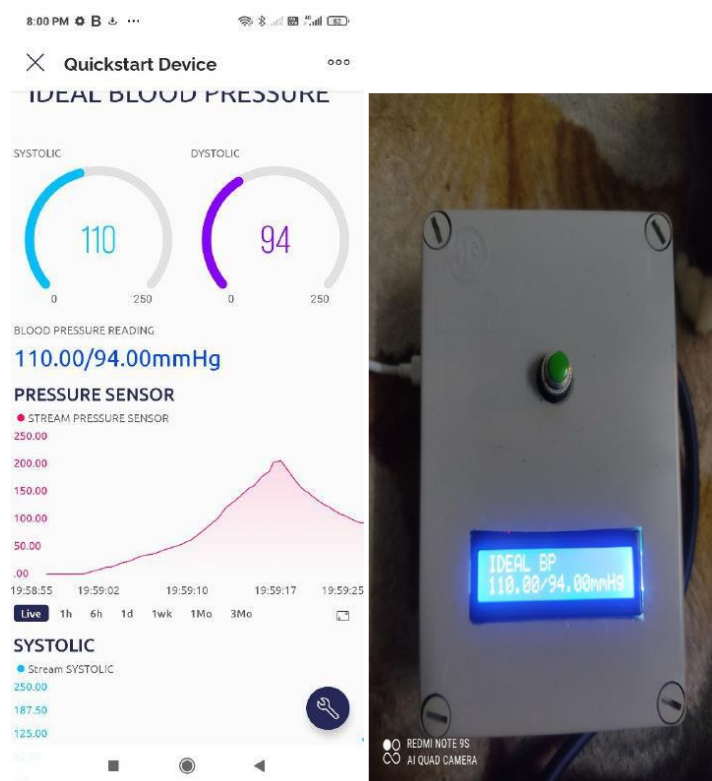

Patient 2

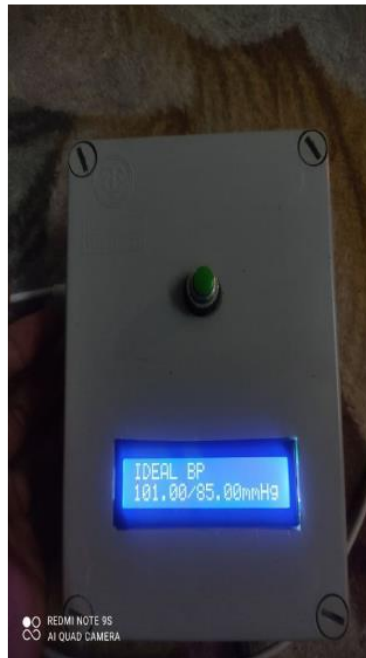

Patient 3

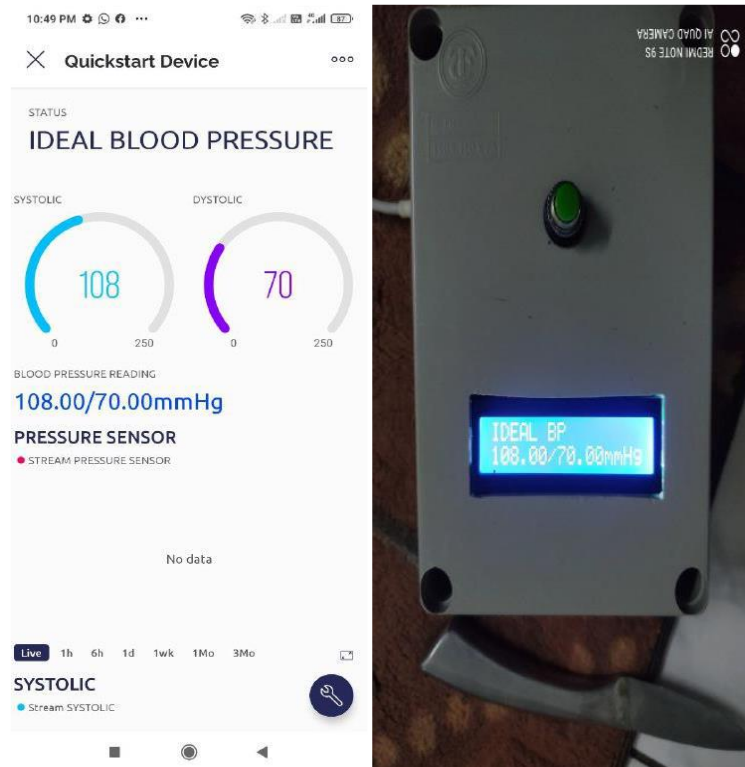

4.3 Discussion

PATIENT	SYSTOLIC	DYSTOLIC
PATIENT 1	110.00	94.00mmHg
PATIENT 2	101.00	85.00mmHg
PATIENT3	108.00	70.00mmHg

Based on the result, the accuracy of designed BP sensor is still the main obstacle of the project. The accuracy of direct BP measurement is not sufficient, this also will gives similar result when integrates with wireless part. Therefore, this is the main reason why the wireless part is not integrated yet with the project. The amplifier

circuit is required more attention before improving the other parts of the design. This is due to the noise of the LM741. Other than that, the BP sensor should be using components rated at 5V and below. This to ensure, the overall design of the project is used single power supply. Thus, it will provide simpler designed of the system. Last but not least, the integration between BP sensor and wireless technology should be started as the accuracy of the BP sensor is successfully achieved.



4.4 Chapter Summary

This Tutorial/Project will show the simplest First IOT project with NodeMCU, how to light a Physical-LED connected to any NodeMCU Digital pin by using the button/button in the Blynk App and the simplest sketch. LED is the simplest example to see the communication on the App Blynk works fine. After successfully turning on the LED, which requires a HIGH Output, you can then directly replace the LED with a Relay Module to turn on the blood pressure monitor machine by changing the coding. Using the Blynk App with the NodeMCU is very easy, but the NodeMCU needs to be connected to a WiFi source that has a phone hotspot Internet.

CHAPTER 5

APPENDICES

APPENDIX A- DATA SHEET



SIJIL

PENYERTAAN

DIBERIKAN KEPADA

MUHAMMAD AQIL BIN JUMRI



telah menyertai pameran projek akhir pelajar

**ELECTRICAL & ELECTRONIC ENGINEERING
INNOVATION COMPETITION**

anjuran
JABATAN KEJURUTERAAN ELEKTRIK
11 MEI 2023

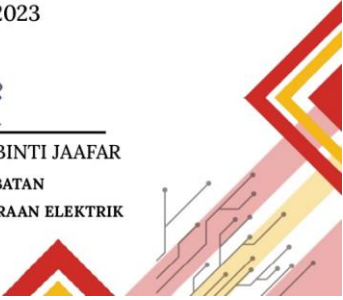

TS. NORAZLINA BINTI JAAFAR
KETUA JABATAN
JABATAN KEJURUTERAAN ELEKTRIK



APPENDIX B- PROGRAMMING

Coding

```
#include <SoftwareSerial.h>

#include <Wire.h>

#include "HX711.h"

#define REPORTING_PERIOD_MS 1000

#include <Wire.h> // Comes with Arduino IDE

#include <LiquidCrystal_I2C.h>

#define Valve 9

#define Pump 5

#define SW 4

#define Buzz 6

HX711 scale(A0, A1);

SoftwareSerial ss(2, 3);

LiquidCrystal_I2C lcd(0x27, 16, 2);
```

```
float Sys2=0;

float Dys2=0;

int BPSTATUSRES=0;

int Rel=0;

//-----

String BPRST="";

int TPTEST=0;

int LoopTest=0;

float Tolerance=0, Tolerancex=0;

int Check=2;

float Sys,Dys;

float PressU=0,PressX=0,PressD=0, TD=0;;

int TH=0;

float REF=10090000;

float MAX=150;

float WEIGHT,Press,Press2;

float RAWPRESS,RAWPRESS2;

float P1,P2,Pr1,Pr2;

int TimeCheck=0;

int ModeOp=0;

float BPMf=0, Tolerancef=0;

int Alm1=0;
```



```
int Alm2=0;

int BPTest=0;

int BackCount=0;

float BPMc,TEMPc,SPO2c,BPc;

float BPMx=0;

float TEMPx=0;

float BPMF=0,TEMPF=0;

float SPO2x,SPO2f;

float Tbefore=0;

uint32_t tsLastReport = 0;

int COUNTER=0;

float Sens1;

int Sens1Pin = 0;

int MODE=0;

int WifiTimer=0;

int CountCheck=0;

int CounterCheck=0;

int STARTX=0;

void setup()

{

    pinMode(SW,INPUT);

    digitalWrite(SW,HIGH);

    pinMode(Valve,OUTPUT);
```

```
pinMode(Pump,OUTPUT);  
digitalWrite(Pump,LOW);  
digitalWrite(Valve,LOW);  
pinMode(Buzz,OUTPUT);  
lcd.begin();  
lcd.clear();  
lcd.setCursor(0, 0);  
lcd.print("Initialize ");  
lcd.setCursor(0, 1);  
  
Serial.begin(9600);  
ss.begin(9600);  
InitBP();  
//-----  
lcd.clear();  
lcd.setCursor(0,0);  
lcd.print("WELCOME..");  
lcd.setCursor(0,1);  
digitalWrite(Buzz,HIGH);  
delay(30);  
digitalWrite(Buzz,LOW);  
delay(30);  
digitalWrite(Buzz,HIGH);
```

```
delay(30);  
digitalWrite(Buzz,LOW);  
delay(30);  
digitalWrite(Buzz,HIGH);  
delay(30);  
digitalWrite(Buzz,LOW);  
delay(30);  
lcd.clear();  
lcd.setCursor(0,0);  
lcd.print("Press button to");  
lcd.setCursor(0,1);  
lcd.print(" check B.Pressure");  
  
}  
void loop()  
{  
  
if (digitalRead(SW)==0){  
lcd.clear();  
lcd.setCursor(0,0);  
lcd.print("Pls relax your");  
lcd.setCursor(0,1);  
lcd.print("hand..");
```

```

delay(1000);

lcd.clear();

Check=0;
}
RAWPRESS = (scale.read());
Press=((RAWPRESS-REF)/REF)*40;
Press=((Press)*10)-50;
Press=Press+30;
if (Check==2){
Serial.println(Press);
}
if (Check==0) {
RAWPRESS = (scale.read());
Press=((RAWPRESS-REF)/REF)*40;
Press=((Press*10)-50;
Press=Press+30;
Serial.println(Press);

lcd.setCursor(0,0);
lcd.print("Sensor:");
lcd.print(Press,1);
ss.print("*");
ss.print(Press);
ss.println("#");
if (BPTest==0){
  Sys=0;
  Dys=0;
// Serial.println(Press);
  BPTest=1;
  PressX=0;
  digitalWrite(Valve,LOW);
  delay(1000);
  digitalWrite(Pump,HIGH);

```

```

}

if (BPTest==1){
// Serial.println(Press);
if (Press>205){ //260
    PressX=Press;
    digitalWrite(Pump,LOW);
BPTest=2;
}
}

if (BPTest==2){
    TPTEST++;
    TD=PressX-Press;
    PressX=Press;
    Rel++;
    if (Press<100){

        digitalWrite(Valve,HIGH);
    }

    if (Sys==0 && Dys==0){
        if (Press <160){//120
            // digitalWrite(Valve,HIGH);
            Sys=TPTEST * 5.714285;
            Sys=(Sys*0.6*1.7142857)-20;
        }
    }
    if (Sys>0 && Dys==0){
        if (TD>=-0.1 && TD<0.1){
            Dys=Press-60.0;
            digitalWrite(Valve,HIGH);
            //digitalWrite(Valve,HIGH);
        }
    }
}

Serial.print(Press);
Serial.print("\t");
Serial.print(TD);
Serial.print("\t");
Serial.println(TPTEST);
if (Press<95){

BPTest=0;
    Check=2;
    STARTX=1;

    if (Dys==0){
        Sys=Sys2;
        Dys=Dys2;

```

```

}
if (Sys>150){
  Sys=Sys2;
  Dys=Dys2;
}

if (Sys>140){
  BPSTATUSRES=2;
  lcd.clear();
  lcd.setCursor(0,0);
  lcd.print("HIGH BP!");
  lcd.setCursor(0,1);
  digitalWrite(Buzz,HIGH);
}
if (Sys>120 && Sys <=140){
  BPSTATUSRES=1;
  lcd.clear();
  lcd.setCursor(0,0);
  lcd.print("PRE-HIGH BP!");
  lcd.setCursor(0,1);
  digitalWrite(Buzz,HIGH);
}
if (Sys>90 && Sys <=120){
  BPSTATUSRES=0;
  lcd.clear();
  lcd.setCursor(0,0);
  lcd.print("IDEAL BP");
  lcd.setCursor(0,1);

}
if (Sys <=90){
  BPSTATUSRES=3;
  lcd.clear();
  lcd.setCursor(0,0);
  lcd.print("LOW BP!");
  lcd.setCursor(0,1);
  digitalWrite(Buzz,HIGH);
}
if (Dys!=0){
  lcd.print(Sys);
  lcd.print("/");
  lcd.print(Dys);
  lcd.print("mmHg");

  Serial.print("Blood Pressure:");
  Serial.print(Sys);
  Serial.print("/");
  Serial.print(Dys);
  Serial.print("mmHg");
  TPTEST=0;
  BPRST=String(Sys)+"/"+String(Dys)+"mmHg";
  ss.print("*");
}

```

```

ss.print(Press);
ss.print("*");
ss.print(Sys);
ss.print("*");
ss.print(Dys);
ss.print("*");
ss.print(BPRST);
ss.print("*");
ss.print(BPSTATUSRES);

ss.println("#");
// delay(3000);
BPRST="";
BPSTATUSRES=0;
}
    delay(3000);
    digitalWrite(Buzz,LOW);
    delay(3000);
    Rel=0;
    digitalWrite(Valve,LOW);
    }
}
if (Check==3){

}

Sys2=random(100,140);

Dys2=random(70,100);

while (ss.available()) {
    // get the new byte:
    char inChar1 = (char)ss.read();
    // add it to the inputString:
    if (inChar1 == '!') {
        STARTX=1; Check=0; ModeOp=0; InitBP();
    }
}

void serialEvent() {
    while (Serial.available()) {
        // get the new byte:
        char inChar = (char)Serial.read();
        // add it to the inputString:
        if (inChar == '!') {

```



```

    STARTX=1; Check=0; ModeOp=0; //InitBP();
  }
}
}
void InitBP(){
  //-----
  // Serial.println("Pressure1 startup");

  //Serial.println("Before setting up the scale:");
  //rial.print("read: \t\t");
  scale.read(); // print a raw reading from the ADC

  scale.read_average(20); // print the average of 20 readings from the ADC

  // Serial.print("get value: \t\t");
  scale.get_value(5); // print the average of 5 readings from the ADC minus the tare
weight (not set yet)

  //Serial.print("get units: \t\t");
  (scale.get_units(5), 1); // print the average of 5 readings from the ADC minus tare
weight (not set) divided
  // by the SCALE parameter (not set yet)

  scale.set_scale(2280.f); // this value is obtained by calibrating the scale
with known weights; see the README for details
  scale.tare(); // reset the scale to 0

  (scale.read()); // print a raw reading from the ADC

  (scale.read_average(20)); // print the average of 20 readings from the ADC

  (scale.get_value(5)); // print the average of 5 readings from the ADC minus the tare
weight, set with tare()

  (scale.get_units(5), 1); // print the average of 5 readings from the ADC minus tare
weight, divided
  // by the SCALE parameter set with set_scale

  delay(2000);



  delay(1500);
  //-----

  Serial.print("Initializing sensor BP");
  // InitMax();
}

```

APPENDIX C- PROJECT MANUAL/PRODUCT CATALOGUE

BLOOD PRESSURE WITH IOT

1 INTRODUCTION

A sphygmomanometer is a device for measuring blood pressure that consists of an inflatable cuff that contracts and releases the artery under the cuff in a controlled manner, [1] and a mercury or aneroid manometer to measure the pressure. Manual sphygmomanometers are used in conjunction with a stethoscope when the auscultation technique. A sphygmomanometer consists of an inflatable cuff, a measuring unit (the mercury manometer or aneroid manometer), and a mechanism for inflation, which may consist of a manually operated piston and valve or an electrically operated pump. The wireless blood pressure monitor is very important nowadays because it is an instrument for measuring blood pressure. At the same time, this wireless blood pressure monitor can also measure pulse. This device is easy to use, you just need to put the "cuff" on your wrist. Blood pressure measurement devices on the market today do not have a function that allows the user to save blood pressure data directly through a smartphone. The availability of this wireless blood pressure monitor adds a feature that allows data to be saved from the blood pressure monitor to the smartphone. The size of this wireless blood pressure monitor is small and easy to take anywhere.

2 OBJECTIVE PROJECT

The purpose of this project is:



1. To develop non-invasive continuous blood pressure monitoring that is portable and easy to operate for ordinary people.
2. To test the non invasive continuous blood pressure monitoring function and the accuracy of the device
3. To compare the data between continuous reading and non continuous

3 ADVANTAGES OF THE PROJECT

According to the research, this wireless blood pressure was created specifically for the ordinary people to make it easier to collect data from previous check up. By using this wireless blood pressure , they can save time and energy to do a check up for Hypertension (high blood pressure). By simply using the blood pressure and automatic saved into their smartphone. They can check their blood pressure data easily . As the result , this wireless blood pressure are more cheaper than existence product in the market and complete with Wi-Fi and Bluetooth to connect into smartphone.

4 THE PROJECT

This is the project that I build by myself . It took me 10 weeks to make this project . It has cuff, put the cuff to the patient's arm After that, turn on the project and press the green button. The led will show the value of blood pressure that being measure

5 BLOCK DIAGRAM

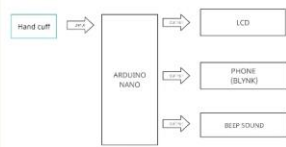

```

graph LR
    HC[Hand cuff] --> AN[ARDUINO NANO]
    AN --> LCD[LCD]
    AN --> P[PHONE (BLUETOOTH)]
    AN --> BS[BEEP SOUND]
    
```

AUTHORS

MUHAMMAD AQL BIN JUMRI
08DEU20F2023

SUPERVISOR

PUAN SITI HAJAR BINTI ABDUL HAMID

CHAPTER 6

PROJECT MANAGEMENT AND COSTING

1.15 Introduction

Project management and costing are integral components of successful project execution, whether it involves a small-scale initiative or a large-scale endeavor. Efficient project management ensures optimal resource utilization, adherence to timelines, and the achievement of objectives. Additionally, accurate costing provides valuable insights into the financial aspects of the project, enabling stakeholders to make informed decisions and maintain financial control.

This report focuses on project management and costing within the specific context of developing a blood pressure monitoring system with IoT. The project entails a total estimated cost of RM549, encompassing various expenditures associated with hardware, software, and other project-related activities.

The primary objectives of this report are to outline fundamental principles and practices of project management, discuss the significance of cost estimation and control, and analyze specific costing aspects pertinent to the blood pressure monitoring system project. By examining these aspects, a comprehensive understanding will be attained regarding the role project management and costing play in successfully completing the aforementioned project.

Throughout the report, various project management methodologies and techniques applicable to the project will be explored. These methodologies encompass defining project goals and scope, developing a project plan, allocating resources, managing risks, and monitoring project progress. Furthermore, cost estimation techniques, such as bottom-up estimation and parametric estimation, will be investigated, alongside cost control mechanisms to ensure adherence to the project budget.

Acquiring insights into project management and costing equips project stakeholders with the ability to effectively plan, execute, and monitor the project while ensuring financial control and meeting project objectives. Moreover, these acquired skills can be applied to future projects, enabling individuals to navigate the intricacies of project management and optimize resource allocation.

The subsequent sections of this report delve deeper into project management methodologies, cost estimation techniques, and the specific breakdown of costs pertaining to the blood pressure monitoring system project.

1.16 Gant Chart and Activities of the Project

Legend:

 Main Task (Actual)
 Main Task (Plan)
 Sub-Task (Plan)
 Sub-Task (Actual)

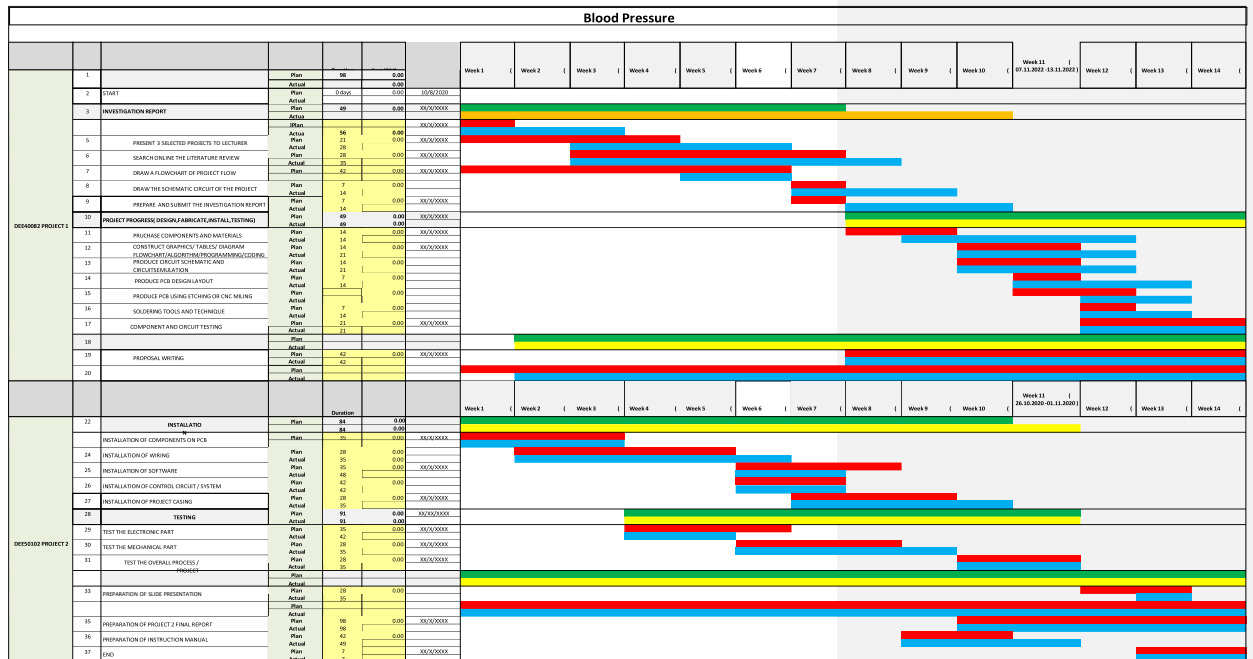

Week 7	Week 8	Week 9	Week 10	Week 11	Week 12	Week 13	Week 14
08.10.2022 - 09.10.2022	09.10.2022 - 10.10.2022	11.10.2022 - 12.10.2022	13.10.2022 - 14.10.2022	15.10.2022 - 16.10.2022	17.10.2022 - 18.10.2022	19.10.2022 - 20.10.2022	21.10.2022 - 22.10.2022

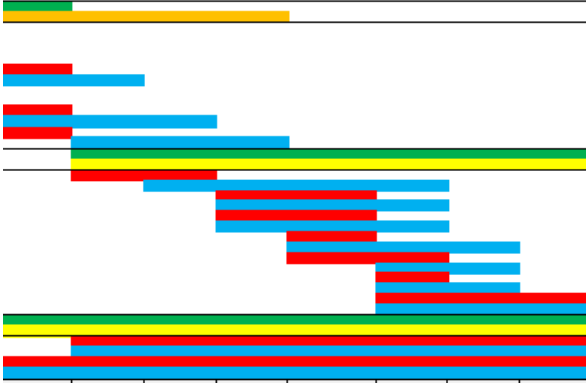

Week 7	Week 8	Week 9	Week 10	Week 11	Week 12	Week 13	Week 14
21.09.2020 - 27.09.2020	05.10.2020 - 11.10.2020	12.10.2020 - 18.10.2020	19.10.2020 - 25.10.2020	26.10.2020 - 01.11.2020	02.11.2020 - 08.11.2020	09.11.2020 - 15.11.2020	16.11.2020 - 22.11.2020

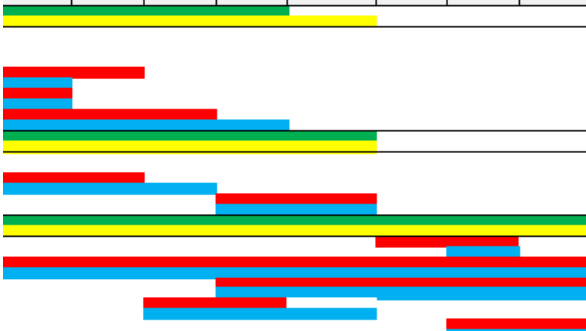

1.17 Cost and Budgeting

No.	Component and materials	The unit price	Quantity	Total
1	Arduino Uno Rev3	RM 109	1	RM 109
2	Microcontroller (ATmega328)	RM 10.99	1	RM 10.99
3	Pressure sensor	RM 44.20	1	RM 42.20
4	Air Pump (KPM27v)	RM 4.40	1	RM 4.40
5	LCD display	RM 17.90	1	RM 17.90
6	Resistor	RM0.50	7	RM 3.50
7	Diode	RM 0.50	2	RM 1
8	Wire 10m	RM 10	1	RM10
9	Other materials	RM 50	-	RM 50
Total :		RM 248.99		
List of other costing				
1	Transportation			
2	Postage			
3	Craft Work			
4	Internet			
5	Application			
Total :		RM300		
Overall total		RM548.99		

Reference

- [1] Santiago Lopez, Blood Pressure Monitor Fundamentals and Design, 2012, Application Note by Freescale Semiconductor.
- [2]Jasa Abdul Rahman, "Design of Portable Blood Pressure Monitor," Universiti Teknologi PETRONAS, Bandar Seri Iskandar, Bachelor Thesis 2007.
- [3] Richard N. Fogoros. (2003, December) About.com - Heart Health Center. [Online]. <http://heartdisease.about.com/cs/starthere/a/chambersvalves.htm>
- [4] Jeremy Booth, "A Short History of Blood Pressure Measurement," *Proceedings of the Royal Society of Medicine*, vol. 70, pp. 793-799, November 1977.
- [5] Aminurrashid Noordin, "Cuff - less Blood Pressure Meter," Universiti Teknologi Malaysia, Skudai, Master Thesis 2009.
- [6] InternationalDrugMart.com. (2013) Blog.internationaldrugmart.com. [Online]. <http://blog.internationaldrugmart.com/>
- [7] S Daochai, W Sroykham, Y Kajornpredanon, and C Apaiwongse, "Non-invasive Blood Pressure Measurement: Auscultatory method versus Oscillometric method," in *The 2011 Biomedical Engineering International Conference (BMEiCON-2011)*, Chiang Mai, 2011, pp. 221 - 224.
- [8] Nor Azura Mohamed Yusof, "Portable Digital Blood Pressure Monitor Blood Pressure Coding System," Universiti Teknikal Malaysia Melaka, Hang Tuah Jaya, Bachelor Thesis 2007.
- [9] Dr. P. Laurent. (2011, December) Blood Pressure & Hypertension. [Online]. <http://www.blood-pressure-hypertension.com/how-to-measure/measure-bloodpressure-8.shtml>
- [10] Arduino. (2013, July) Arduino. [Online]. <http://www.arduino.cc/>
- [11] C. Douniama, C. U. Sauter, and R. Couronne, "Blood Pressure Tracking Capabilities of Pulse Transit Times in Different Arterial Segments: A Clinical Evaluation," *Computers in Cardiology*, vol. 36, September 13-16 2009.
- [12] Heiko Gesche, Detlef Grosskurth, Gert Ku"chler, and Andreas Patzak, "Continuous Blood Pressure Measurement by Using the Pulse Transit Time: Comparison to a Cuff-based Method," April 2011.
- [13] Jin Li Wun, Long Luo Yuan, Shun Chang Yao, and Hsiang Lin Yuan, "A Wireless Blood Pressure Monitoring System for Personal Health Management,"

33

in *32nd Annual International Conference of the IEEE EMBS*, Buenos Aires, Argentina, 2010, pp. 2196-2199.

[14] Dr. Neil Townsend, "Medical Electronics," *Michealmas Term 2001*, pp. 48-54, 2001.

[15] Md Manirul Islam et al., "Development of a Noninvasive Continuous Blood Pressure Measurement and Monitoring System," in *International Conference on Informatics, Electronics & Vision*, Dhaka, Bangladesh, 2012.

