



**POLITEKNIK SULTAN SALAHUDDIN ABDUL AZIZ
SHAH**

VEGETABLES BOARD

**INTAN NUR MASNISA BINTI OMAR
(08DBK20F2011)**

**SITI HAIFA SAFURA BINTI MAT ZAID
(08DBK20F2015)**

**CIVIL ENGINEERING DEPARTMENT WOOD
BASED TECHNOLOGY PROGRAMME**

SESI 2 2022/2023

**POLITEKNIK SULTAN SALAHUDDIN ABDUL
AZIZ SHAH**

VEGETABLES BOARD

INTAN NUR MASNISA BINTI OMAR

(08DBK20F2011)

SITI HAIFA SAFURA BINTI MAT ZAID

(08DBK20F2015)

**This report was submitted in Partial Full of Requirements for the
Diploma in Wood Based Technology, Department of Civil
Engineering Polytechnic Sultan Salahuddin Abdul Aziz Shah**

CIVIL ENGINEERING DEPARTMENT

SESI 2: 2022/2023

DECLARATION OF ORIGINAL AND OWNERSHIP

1. We are third-year Diploma students in Wood-Based Technology, Civil Engineering Department, Politeknik Sultan Salahuddin Abdul Aziz Shah.
2. We acknowledge that our Vegetables Board is not taken or copied from any party but rather the work/design of our group itself.
3. Made and truly acknowledged by the said;

a) Students Signature : 
Student Name : Intan Nur Masnisa Binti Omar
No Matrix : 08DBK20F2011
Date : 25 MEI 2023

b) Students Signature : 
Student Name : Siti Haifa Safura Binti Mat Zaid
No Matrix : 08DBK20F2015
Date : 25 MEI 2023

APPROVAL SHEET

Checked by:

Supervisor : Mariani Ayu Binti Omar

Signature :



Date : 26/MEI/2023

MARIANI AYU BT. OMAR
Pensyarah
Jabatan Kejuruteraan Awam
Politeknik Sultan Salahuddin
Abdul Aziz Shah

Verified by:

Project Coordinator : En. Zullhzyrifee Ishraf Bin Zulkify

Signature :

Date :

ACKNOWLEDGEMENT

First and foremost, we would like to express our gratitude to Puan Mariani Ayu Binti Omar, our final year project supervisor, for her assistance and advise. She was eager to spend her valuable time reviewed our report and corrected any errors we had made. We'd also like to thank her for demonstrated a better way to finish this final year's report.

Following that, I'd want to thank the Politeknik Sultan Salahuddin Abdul Aziz Shah for providing services such as a library and internet access. It has simplified our search for information. Furthermore, the kind employees made it easier for us to find information.

We'd also want to thank the internet uploaders who shared a wealth of knowledge types of slicing board, standard sizes, and designs. Furthermore, we would like to convey our heartfelt gratitude to our cherished family for their constant support and encouragement.

Finally, to Mr Hamdi Bin Hj. Mawardi as the owner of the machine (CNC) in Politeknik Sultan Salahuddin Abdul Aziz Shah, parents, classmates, we would like to express a million thanks for support throughout this study. Without their continued support and encouragement, our project would not have been successful. Thanks also to all the members of this group for their cooperation and teamwork spirit.

ABSTRACT

In the kitchen, a slicing board is an indispensable tool for preparing and slicing ingredients such as vegetables. Slicing boards are available in various sizes, densities and materials such as wood, plastic, iron and marble. However, slicing boards made of wood have several advantages over other materials due to their ability to repair wounds in solid wood, have high resistance and antiseptic properties. From the results of the research conducted on 58 respondents consisting of working women, small business owners and students, it was found that 96% needed a container to place sliced ingredients and a place to store knives while cooking. Therefore, a slicing board which is a vegetables board that has a place to place the slicing material and a knife has been produced to solve the problem of respondent.

Key words: slicing board, vegetables board, cutting materials, cutting space

ABSTRAK

Di dapur, papan penghiris adalah alat yang sangat diperlukan untuk menyediakan dan menghiris bahan-bahan seperti sayur-sayuran. Papan penghiris boleh didapati dalam pelbagai saiz, ketumpatan dan bahan seperti kayu, plastik, besi dan marmar. Walau bagaimanapun, papan penghiris yang diperbuat daripada kayu mempunyai beberapa kelebihan berbanding bahan lain kerana keupayaannya untuk membaiki luka pada kayu pepejal, mempunyai rintangan yang tinggi dan sifat antiseptik. Daripada hasil kajian yang dijalankan ke atas 58 orang responden yang terdiri daripada wanita bekerja, peniaga kecil-kecilan dan pelajar, didapati 96% memerlukan bekas untuk meletakkan bahan hirisan dan tempat menyimpan pisau semasa memasak. Oleh itu, papan penghiris iaitu papan sayur yang mempunyai tempat meletakkan bahan penghiris dan pisau telah dihasilkan bagi menyelesaikan masalah responden.

Kata kunci: papan menghiris, papan sayur, bahan pemotong, ruang memotong

TABLE OF CONTENT

CONTENTS	PAGE
APPROVAL SHEET	4
ACKNOWLEDGEMENT.....	5
ABSTRACT	6
ABSTRAK	7
TABLE OF CONTENT	8
LIST OF TABLE	11
LIST OF FIGURE	12
CHAPTER 1	14
1.1 INTRODUCTION	14
1.2 PROBLEM STATEMENT	15
1.3 SIGNIFICANT OF STUDY	16
1.4 OBJECTIVES.....	17
1.5 SCOPE OF STUDY	17
CHAPTER 2	18
LITERATURE REVIEW	18
2.0 INTRODUCTION	18
2.1 MATERIAL USED	18
2.2 RUBBERWOOD	18
2.3 DESIGN	19
2.4 FINISHING	20
CHAPTER 3	21
METHODOLOGY	21
3.1 INTRODUCTION	21
3.1.2 FLOW CHART.....	22
3.1.3 LOCATION	22
3.1.4 DESIGN	23
3.1.5 VEGETABLES BOARD ILLUSION PITCURE	23
3.1.6 SIZE	24

3.2 BIL OF MATERIALS	25
3.3 LIST ON MACHINES AND TOOLS	26
3.4 CUTTING LIST	27
3.5 BUDGET AND COSTING	27
3.6 WORKING PROGRESS	28
3.6.1 CUTTING PROCESS	28
CONSTRAINTS IN THIS PRODUCTS	28
3.6.2 PRODUCT MAKING PROCESS	29
Step 1 : Cut the rubberwood to the required size	29
Step2 : Cut carefully when using a table saw	29
Step 3 : Make a marker to pierce the wood of the slicing board handle.....	30
Step 4: Received guidance from Sir Teo Eng Yeaw.....	30
3.6.3 TESTING FROM CNCN MACHINE	31
Step 1 : Using a CNC machine.....	31
Step 2 : Then flatten the board using a sanding machine	31
Step 3 : Carve the name of the product on the cutting board.....	32
Step 4 : Apply corn oil as finishing.....	32
Step 5: Then the vegetables board was produced until it was finished.....	33
CHAPTER 4	34
FINDING AND DATA ANALYSIS.....	35
4.1 INTRODUCTION	35
4.2 Results and discussion of survey on completed Vegetables Board.....	35
CHAPTER 5	42
CONCLUSION AND RECOMMENDTION	42
5.1 CONCLUSION	42
5.2 RECOMMENDATION	42
REFERENCES	43
GANTT CHART REPORT WRITING	44

APPENDIX 1	45
APPENDIX 1.....	46
APPENDIX 1.....	47
APPENDIX 2	48
APPENDIX 2.....	49
APPENDIX 3	50
APPENDIX 3	51

LIST OF TABLE

TABLE	PAGE
TABLE 1: Conceptual Framework for analysis of slicing board use	16
TABLE 2 : Sander Machines	21
TABLE 3:Process of getting idea to produce product	23
TABLE 4 : List on Machines and Tools	26
TABLE 5: Cutting list	28
TABLE 6 : Preparing Budging & costing	28
TABLE 7 : Working Process	29

LIST OF FIGURE

ITEM	PAGE
FIGURE 1 : Slicing board	14
FIGURE 2: Example of Vegetable Board	15
FIGURE 3 : Example of Rubberwood	18
FIGURE 4 : Example of simple Design	19
FIGURE 5: Example of Design slicing board	19
FIGURE 6 : Example of Corn oil for finishing	20
FIGURE 7 : Location At Wood Workshop JKA,PSA	23
FIGURE 8 : Illusion picture	24
FIGURE 9 :Slicing board	25
(In view of the top view the slicing board)	
FIGURE 10 : Vegetables Board	25
(In view front view the slicing board)	
FIGURE 11 : Vegetables Board	25
(In view of the side of the slicing board)	
FIGURE 12 : Bil of material	26
FIGURE 13 : Cut the Rubber wood by using Table saw machine	30
FIGURE 14 : Trim the rubber wood	30
FIGURE 15: Cut hole parts for handles with scroll saw machine	31
FIGURE 16 : Use a scroll saw machine	31
FIGURE 17 : Using a CNC machine for cutting process	32
FIGURE 18 : Process sanding machine	32
FIGURE 19 : Using a machine Laser Engraving	33
FIGURE 20 : The process of finishing the vegetable board	33
FIGURE 21 : Results Product	34
FIGURE 22 : Vegetables Board	35
FIGURE 23 : Vegetables Board	35

LIST OF DIAGRAM

ITEM	PAGE
DIAGRAM 1 : Gender of respondent	36
DIAGRAM 2 : Nation	37
DIAGRAM 3 : Category of respondents	37
DIAGRAM 4 : Job of respondent	38
DIAGRAM 5 : The vegetables board can save a container to place	39
DIAGRAM 6 : The cutting board space is ideal	39
DIAGRAM 7 : Rubber wood is suitable for this product	40
DIAGRAM 8 : Cutting board design set	40
DIAGRAM 9 : Buying and booking material	41

CHAPTER 1:

INTRODUCTION

1.1 BACKGROUND OF STUDY

A slicing board is a durable board used to place cooking ingredients such as vegetables that will be cut or sliced during the cooking process. Slicing boards in the kitchen are usually made of wood, plastic, iron or marble and come in various sizes, thicknesses, and widths. Slicing boards made of wood have several advantages over other materials because the wood has its own ability to close or heal wounds in high-density wood, has strong resistance and is very flexible to use. Wood also has natural antiseptic properties.

However, through a survey conducted on 58 respondents consisting of housewives, working women, small traders and students, it was found that 96% or 58 respondents stated that they faced problems when using slicing boards because they had to prepare many containers in one time to put the sliced material and there is also no safe place to put the knife while cooking in the kitchen.

Therefore, our group will produce a Vegetables Board, which is a slicing board that has space to place sliced ingredients and also a knife so that the user's or respondent's problem can be solved.



Figure 1 : Slicing Board

1.2 STATEMENT OF THE PROBLEM

A slicing board is one of the most important tools for the initial cooking process of a food dish. The results of surveys and interviews conducted, with respondents and users such as housewives, small traders, working women and students are the problem of space and space for knives. And have a problem when they operate a slicing board that doesn't have room to put the sliced ingredients. Therefore, if there is no space to put the knife, then the issue that will happen to the user is the issue of accidents. This causes the user and will face accidents like wounds. If they are careless when using a knife while doing other work in the kitchen, then it is clear that the issue of safety is also very important when the user is doing work that will cause an accident.



Figure 2 : Vegetables board

Therefore, we wanted to innovate the latest slicing board with a slot space for the slicing material and space to place the knife. Both elements are very important to complete convenience for users.

The conceptual model that will be used for the study is presented in Figure 1. The variables based on this study are the use of slicing board use patterns and problematic use, while the dependent variable is Safety.

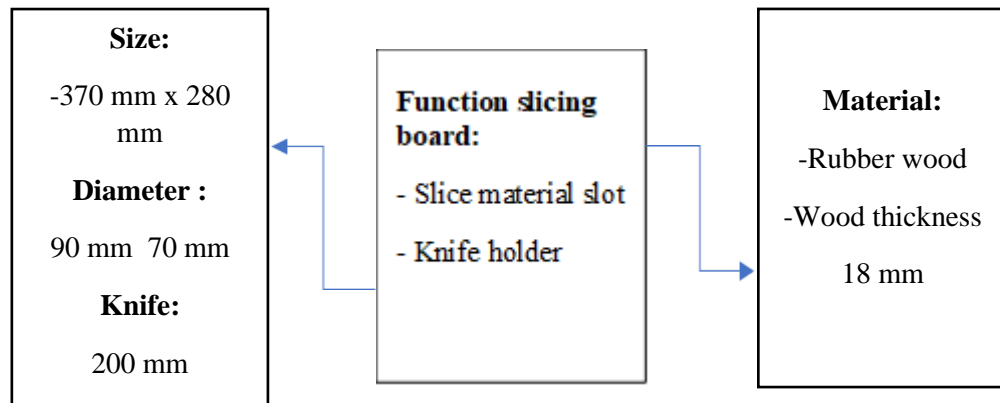

Table 1: Conceptual Framework for analysis of slicing board use

1.3 SIGNIFICANT OF STUDY

A slicing board is an important kitchen tool, it is mainly used for slicing cooking ingredients. This wooden slicing board is the best. A slicing board is a very important kitchen tool to use, especially for slicing vegetables. This wooden slicing board is the main tool before the cooking process. Nowadays, many consumers have several purpose-built slicing boards at home. This is intended because here the importance of the slicing board will be emphasized to the user. Therefore, the study found that the most popular use of this slicing board is among housewives, working women, small traders and students or all levels regardless of young or old age.

Next, the importance of research studies is to know the results of practical products. Here, the wood we design is from rubber wood. So with this, we can design a slicing board from solid wood that has long durability and high quality. However, we can see and understand the durability of the sliced board. The surface of the slicing board should not be so hard that it can dull or damage the knife. This is often a problem with many materials such as glass, ceramic and some wooden slicing board options. A softer surface is the best choice because a kitchen knife can attack it without damaging the blade.

In addition, we can learn about this product more deeply or extensively. However, what we want to innovate and produce this product is that it has a place to put the knife

and most importantly we provide a space to put the material of the slicing slot in the place of the slicing board for the user and also the knife space. However, the findings from this study are from the idea that we are looking for a suitable slicing board material that what we design is very much in line with what we expect. So with this, we have a product that we designed that is attractive but functionally very useful for today's users. *(From House of knives) 04 July 2021.*

1.4 Objective

The objectives of this project :

To produce a sliced board that is a Vegetables Board that has space to place the sliced material and also a knife.

1.5 SCOPE STUDY

This study will be conducted at the wood workshop, Laser Incubator Room, JKA, PSA. Through the findings of the research that has been done, we will produce a slicing board made from rubberwood board measuring 370 mm x 280 mm. The resulting slicing board has two spaces with a diameter of 90 mm x 70 mm to place the sliced material and one space to place the knife.

CHAPTER 2

LITERATURE REVIEW

2.1 INTRODUCTION

A slicing board is a durable board on which to place materials for cutting. Kitchen slicing boards are usually used in preparing food. Kitchen slicing boards are often made of wood or plastic and come in various widths and sizes. There are also slicing boards made of glass, steel, and marble. (*Anonymous ,Feb 2023*) Its main purpose is to be the surface on which all slicing, dicing, and cutting. (*Anonymous,2022*)

2.2 MATERIAL USED

2.2.1 Rubberwood

Rubber wood is a light-coloured medium-density tropical hardwood obtained from the Pare rubber tree (*Heave brasiliensis*), usually from trees grown in rubber plantations. Rubberwood is commonly advertised as an "environmentally friendly" wood, as it makes use of plantation trees that have already served a useful function. It has a dense grain that is easily controlled in the kiln drying process.

Rubberwood also has very little shrinkage making it one of the more stable construction materials available for furniture. It is easily worked, and takes on stains uniformly. As with all hardwoods, rubber wood comes in varying degrees of quality. (<https://en.wikipedia.org/wiki/Rubberwood>)



Figure 3 :Example of Rubberwood

It is a Light Hardwood with a density of 560-640 kg/m³ air dry. The timber is moderately hard and light to moderately heavy. (*Anonymous. 1982. Malaysian Timbers - Rubberwood.*)

The benefits of rubber slicing boards. Rubber is non-porous, which means that bacteria won't penetrate the surface. This translates into a couple of benefits: it won't end up cracking as wooden boards do over time, nor will it leave unsightly food stains as with plastic boards.

Second, this board is made of strong, solid material, and is more scratch resistant than plastic, thus providing a smooth and nice surface to cut. Therefore, rubber boards last longer, which makes up for the higher price tag.

2.2.2 Design

A favourite among chefs and home cooks, wooden slicing boards are great because they're durable, easy on the knife and compact enough for precise cuts. Whether you are slicing vegetables and a wooden slicing board must be in the kitchen lineup.

To find the best wood slicing board, we researched hundreds design of brands while considering qualities such as wood type, grain and size. We also sought the advice of professional chef and cookbook author Leah Cohen. (*KateMcGregor, February 9, 2023*)



Figure 4: Example of simple Design



Figure 5: Example of Design slicing board

2.2.3 FINISHING

Finishing is the final step of the manufacturing process that gives wood surfaces desirable characteristics, including enhanced appearance and increased resistance to moisture and other environmental agents. Finishing can also make wood easier to clean and keep it sanitized, sealing pores that can be breeding grounds for bacteria. Finishing can also influence other wood properties. In addition, finishing provides a way of giving low-value woods the appearance of ones that are expensive and difficult to obtain.

Function of corn oil for finishing slicing boards

Corn oil is the oil extracted from corn kernels. Corn oil has a mild and neutral taste, so it is often used in cooking, food manufacturing, and ingredients in food and beverage products.



Figure 6 : Corn oil for finishing

2.2.4 SANDER MACHINE

A sander is a sanding machine that is driven by electricity to smooth the surface of objects made of metal, wood or concrete or walls, more quickly and efficiently. Abrasive material sandpaper can be used to level the surface of an uneven object so that it can be done according to the purpose of the job.

2.2.5 SANDER MACHINE FUNCTIONS

The function of the sander machine is to smooth the surface of objects (metal, wood, walls or walls) that are not flat like sandpaper in general so that it can be continued for further work according to the purpose of the work.

2.2.6 TYPES OF SANDER MACHINES

In general, the types of sander machines that are generally circulating in the market are as follows:



NO.	Machine	Functions	Picture
1.	Belt Sander	To shaping and finishing wood and other materials.	
2	Orbital Sander	Rotating themselves elliptically to create a smooth surface	
3	Random Orbital Sander	To used for ultra-fine sanding to smooth the surface of wood, wall, metal,	

Table 2 : Sander Machines

CHAPTER 3:

RESEARCH METHODOLOGY

3.1 INTRODUCTION

Methodology is a critical element of the research that should be addressed. This is due to the need to achieve the best possible outcomes in the production of the commodity. The aspects examined include analysis strategies, data collection methods, study procedures, and hypotheses to ensure that the methods used in this study are well studied in an orderly manner and hypotheses to complete the study.

3.1.1 EARLY RESEARCH

Research is underway to find out the problem of slicing boards that do not have a slicing chamber and a blade. We find it especially difficult for users when there is no room for sliced ingredients.

We also provide a questionnaire to users who have such a slicing board to find out the design of the slicing board in their home.

Based on a questionnaire of 58 respondents,

Therefore, our project ensures a slicing board that has a slicing space and is equipped with a knife space.

Our project will be implemented at the PSA Shah Alam wood workshop. Among the processes involved in producing this product are:

- i. Observations in terms of interviews with users
- ii. Design and distribution of questionnaires
- iii. Design planning and costing
- iv. Prepare budgets and costs

3.1.2 FLOW CHART PROCESS

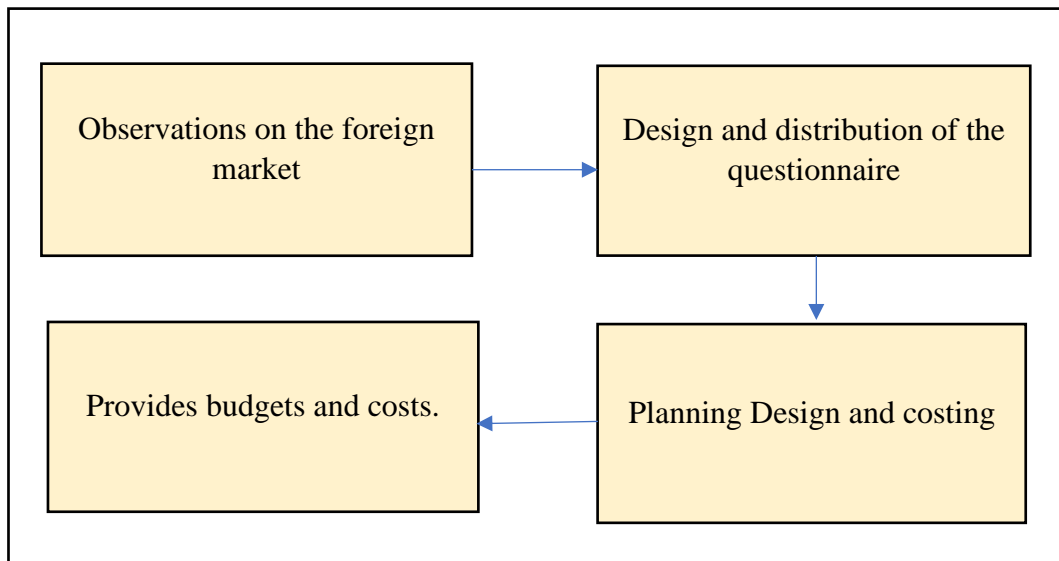

Table 3 :Process of getting idea to produce product

3.1.3 LOCATION

We are do at the PSA Wood Workshop with guidance from the wood workshop lecturer. From that, we were able to produce our sliced boards using machines in the workshop. As a result, we can succeed well and work hard to complete the results by the guidance of the Wood Workshop lecturer.



Figure 7: Location At Wood Workshop JKA,PSA.

3.1.4 DESIGN

It has a space for slicing and the space is like a proud shape because it is easy to use with a hand or a spoon and then has a knife handle.

3.1.5 VEGETABLES BOARD ILLUSION PICTURE

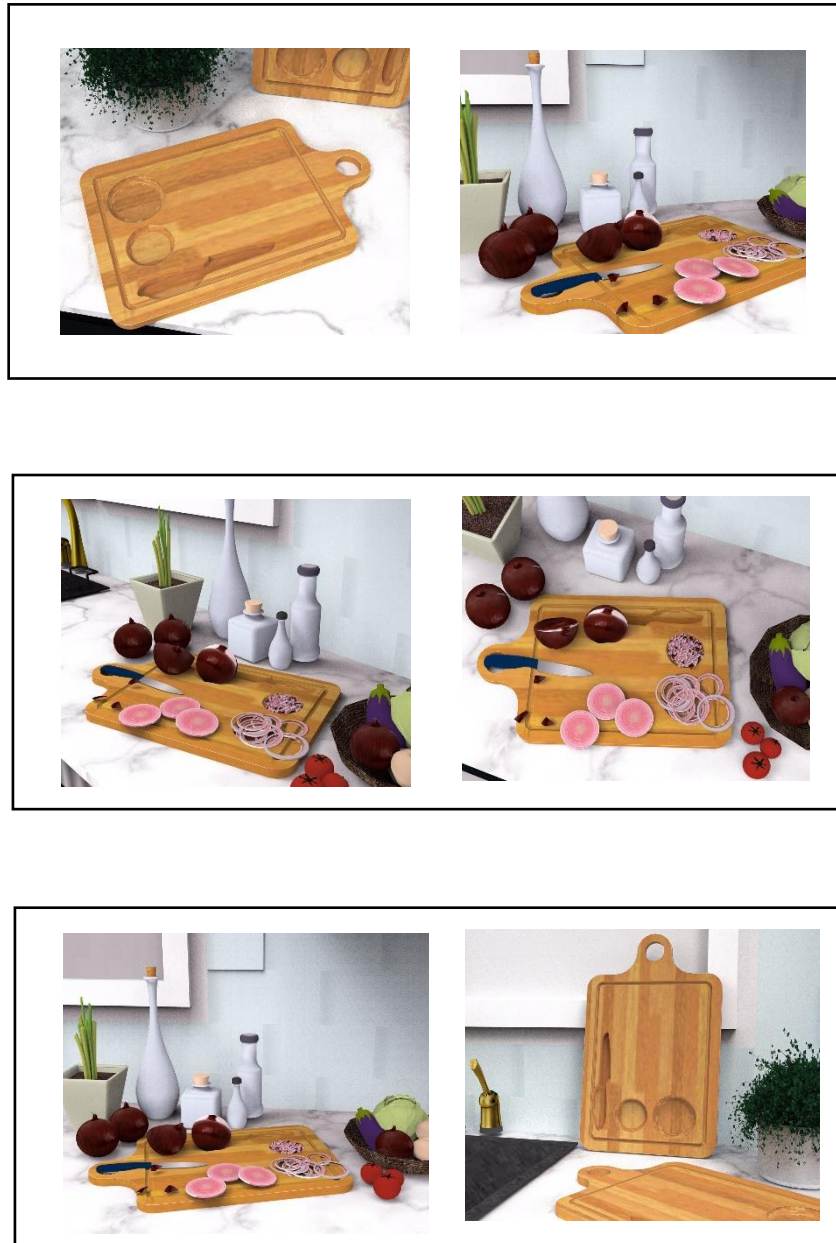

Figure 8 : Illusion picture

3.1.6 SIZE

Dimension is an important aspect in the design of the cutting board to obtain comfort for the user. We must know the size of the frequency table for the user, the size of the slicing board(Rubberwood).

Next, for length x width is 37cm x 28cm. We choose the 37cm length size because it is suitable for the length of one slicing board.

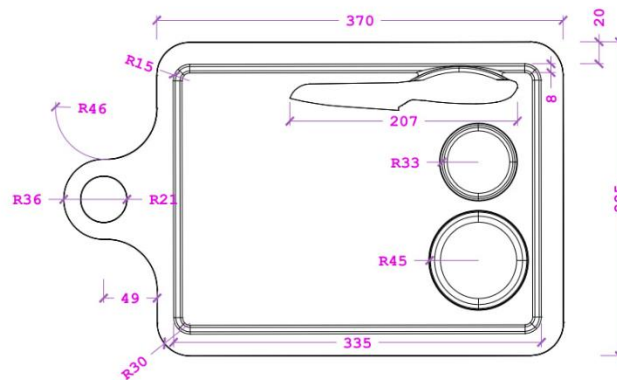
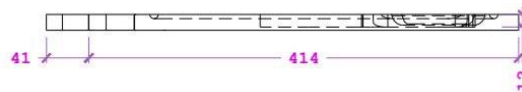

Figure 9 :Slicing board

(In view of the top view the slicing board)



FRONT VIEW

Figure 10: Vegetable Board

(In view front view the slicing board)

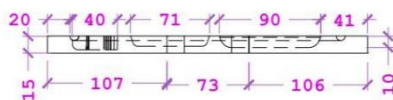

SIDE VIEW

Figure 11 : Vegetable Board

(In view of the side of the slicing board)

3.2 BIL OF MATERIAL



[Product VEGETABLE BOARD										
Assembly Type :		VEGETABLE BOARD								
Assembly Name :										
Material Ratio (mm) :										
Approval Date :										
Part Count :		1								
Total Cost (RM) :		\$20.00								
										Picture of Assembly
										
Category	Part Name	Thickness	Width	Length	Materials	Qty	Units	Picture	Unit Cost	Cost
PART 1	WOOD	18mm	28cm	37cm	RUBBER WOOD	1	1		MYR 36	MYR 36
										MYR -
										MYR -
										MYR -
										MYR -
										MYR -
										MYR -
										MYR -

Figure 12 : Bil of material

3.3 LIST ON MACHINES AND TOOLS



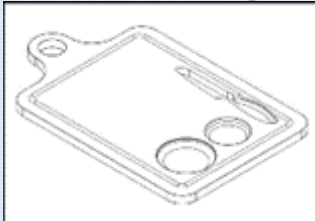



No.	Machine	Function	Picture
1.	Table Saw	To take large sheets of material.	
2.	Cnc Machine	Cut or move material as programmed on the controller.	
3.	Trimmer	Trimming, flushing, jointing, rounding edges and routing grooves and dados.	
4.	Sander	Smoothing, polishing, or cleaning a surface.	
5.	Laser Engraving	A machine that can mark the surface of a material by using a light beam (laser).	
6.	Scroll Saw	Saw blade and cuts short curved parts.	

Table 4 : List on Machines and Tools

3.4 CUTTING LIST

Part Name	Length	Width	Thickness	Quantity	Material
Wood	37 cm	28 cm	18 mm	1	Rubber wood

Table 5: Cutting list

3.5 BUDGET & COSTING

No.	Item	Unit	RM	
			Cost	
			Per/Unit	Total
1.	Rubberwood	30x 60 cm	RM 36.00	RM 42.30
2.	Laser Engraving	-	RM 10	RM 10
3	Sandpaper	1500#	RM 0.28	RM 6.58
4.	Corn Oil	1	RM 8.00	RM 8.00
			Total	RM 66.88

Table 6 : Preparing Budget & costing

3.6 WORKING PROGRESS

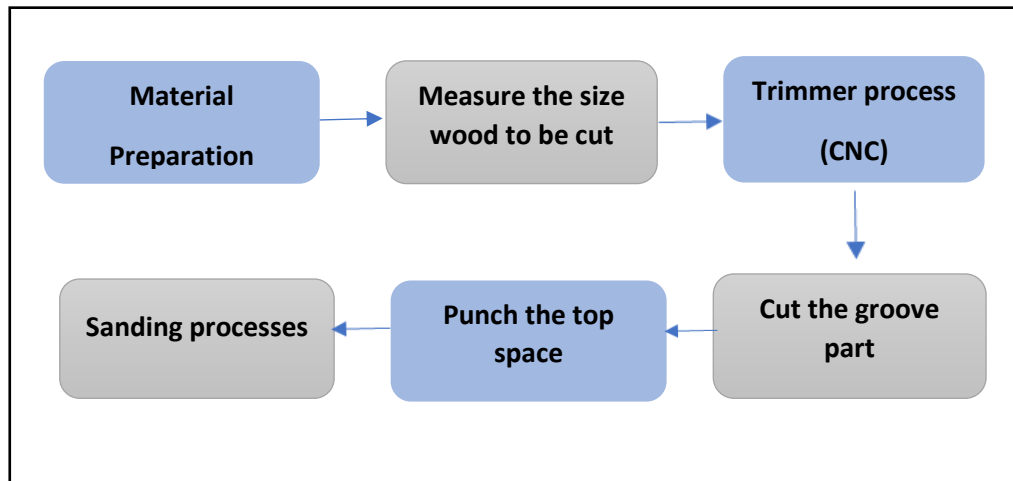

Table 7 :Working Process

3.6.1 CUTTING PROCESS

Cut the rubberwood of the process must be cut according to the cutting list. The table saw is the tool for used in the process.

CONSTRAINTS ON THIS PRODUCT

For additional information, originally our product had the concept of a curve like a concealed hole. However, our CNC machine at PSA does not have points that are suitable for our products to be punched.

So we use the available points. Among them are Flat Bit, Diameter 12 and Ball Nose Diameter 12.

3.6.2 PRODUCT MAKING PROCESS

TESTING MANUAL:

Step 1: Cut the rubberwood to the required size

Before using the table saw, measure and set the length and width of the wood to be cut.



Figure 13 : Cut the Rubber wood by using Table saw machine

Step 2: Cut carefully when using a table saw



Figure 14: Trim the rubber wood

Step 3 : Make a marker to pierce the wood of the slicing board handle



Figure 15 :Cut hole parts for handles with scroll saw machine

Step 4 : Received guidance from Sir Teo Eng Yeaw. After being able to punch and cut using a scroll saw machine, then cut the edges around the wooden board according to the size that has been marked.



Figure 16 : Use a scroll saw machine

3.6.3 TESTING FROM CNC MACHINE

Step 1 : Using a CNC machine for cutting curves can be easily made, and 3D structures can be cut.



Figure 17 : Using a CNC machine for cutting process

Step 2: Then flatten the board using a sanding machine



Figure 18 : Process sanding machine

Step 3: Carve the name of the product (vegetables board) on the cutting board

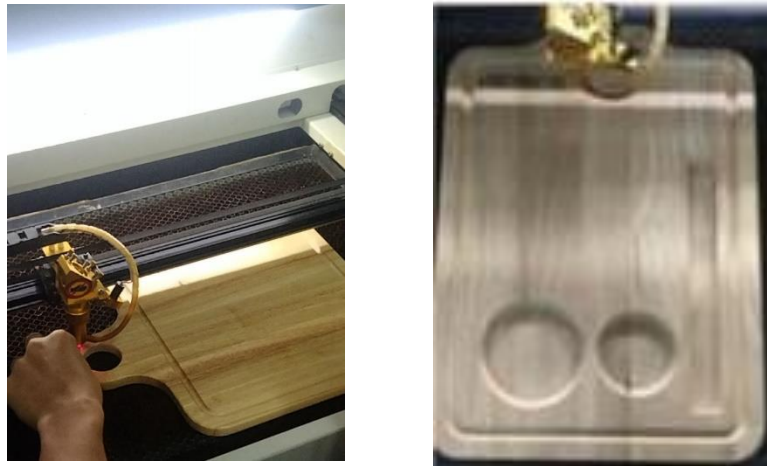

Figure 19 : Using a machine Laser Engraving

Step 4: Apply corn oil as finishing



Figure 20 : The process of finishing the vegetables board

Step 5: Then the vegetables board was produced until it was finished.



Figure 21 : Results Product

CHAPTER 4

FINDING AND DATA ANALYSIS

4.1 INTRODUCTION

Vegetables board has through many steps starting from the idea of a slicing board with different materials that have been used by users and also save space followed by a very exclusive product design to the production of the product. Next, users will be able to use easily and safely and it also easy to do work for daily use before cooking.



Figure 22 : Vegetables Board



Figure 23 : Vegetables Board

4.2 Results and discussion of survey on completed Vegetables Board

We conducted an online survey to get feedback from users after the product was ready. it was answered by 52 respondents.

SECTION A

JANTINA
58 responses

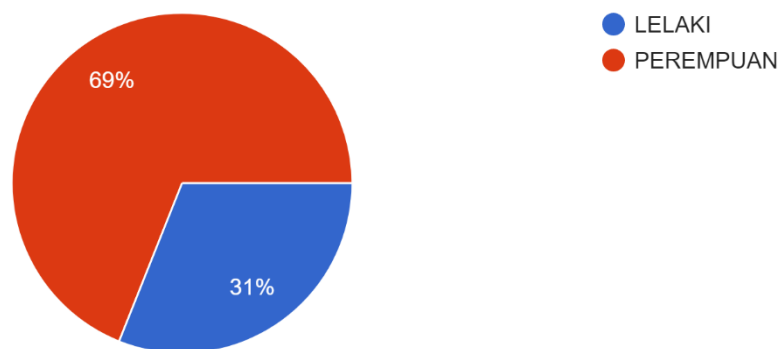

Diagram 1 : Gender of respondent

67.3% of the results show most of the respondents are gender female. Most of them are students and housewife. Meanwhile, a small percentage of 32.7% is from male respondents.

BANGSA
58 responses

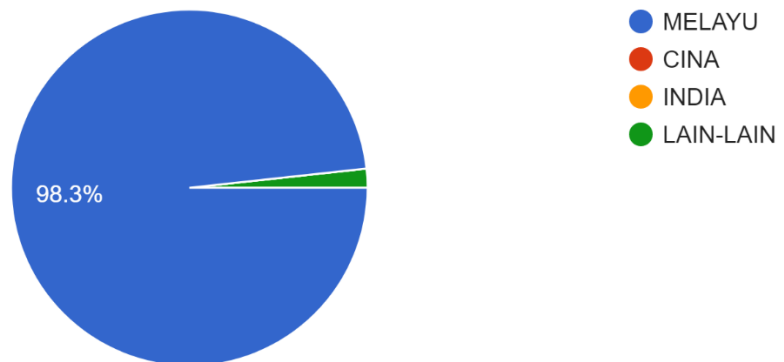

Diagram 2 : Nation

The results of this study show that out total 98.1% of the results show that most of the respondents are Malay. We also distributed a lot of information and questionnaire links to friends, lecturers and others.

KATEGORI
58 responses

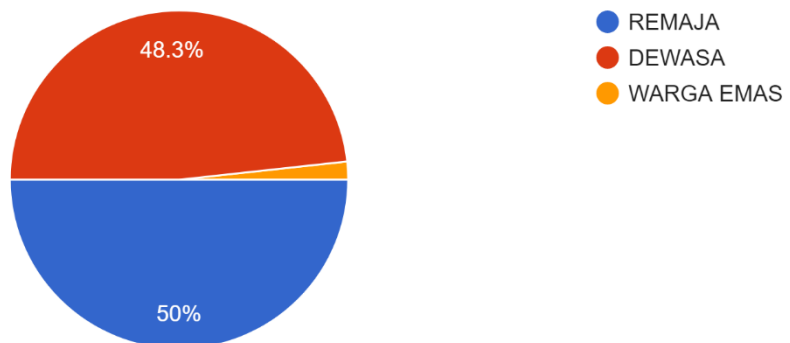

Diagram 3: Category of respondents

This diagram shows that 51.9% of the results of most respondents are among teenagers. Next, as many as 46.2% are from among adults which is slightly different from the percentage of teenagers. And the smallest percentage is the elderly category.

PEKERJAAN

58 responses

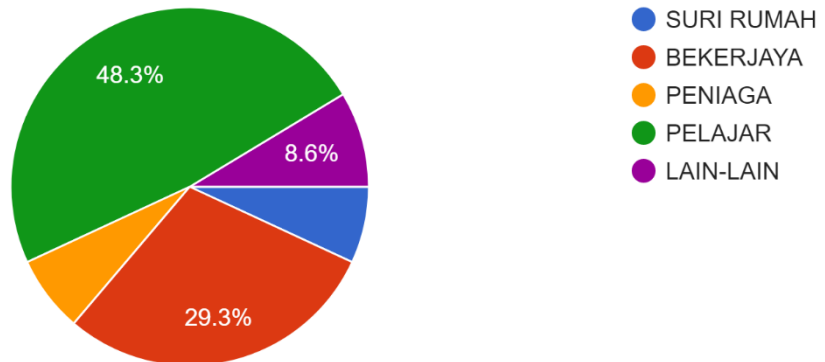

Diagram 4 : Job of respondent

Based on the results of the study, a total of 56 respondents were questioned. So for total 49.1% of the results of most respondents are among students. Next, as many as 29.8% are from people who have a career and are a little far from the percentage of students. However, there are also other percentages that have responded as much as 8.8%. But a small percentage is housewives of 7%.

SECTION B

SOALAN

1. Vegetable board ini dapat menjimatkan bekas untuk meletakkan bahan yang telah dihiris.

58 responses

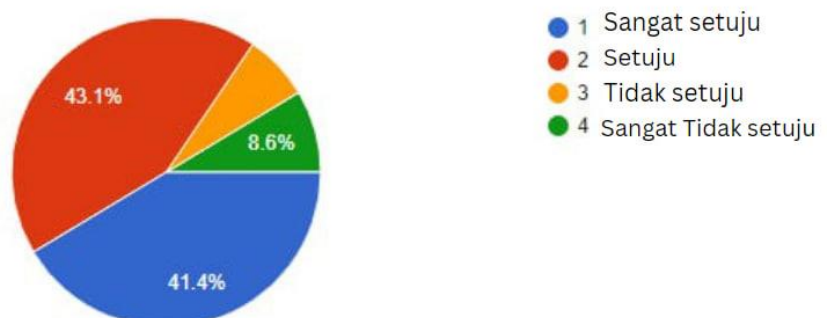

Diagram 5 : The vegetable board can save a container to place

The results of the study show that out of 58 respondents, there are 24 people and the percentage is who STRONGLY AGREE 41.4% and agree as much as 43.1%. Meanwhile, 8.6% DISAGREED.

2. Adakah ruang papan pemotong ini sesuai ?

58 responses

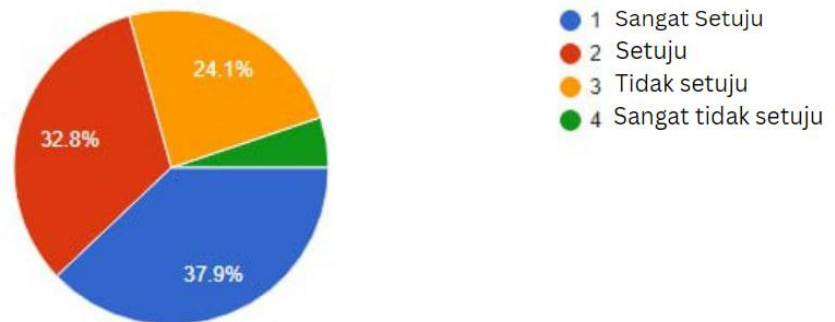

Diagram 6 : The cutting board space is ideal

The diagram above shows the response analysis from the respondents about the cutting board space is ideal. From the analysis, a total of 37.9% (22 of respondents) answered STRONGLY AGREE. While a total of 32.8% (19 people) of among the respondents answered AGREE.

3. Adakah rubber wood sesuai dengan produk ini

56 responses

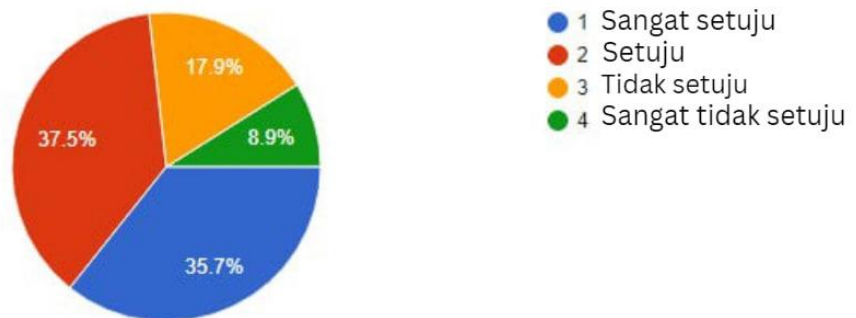

Diagram 7 : Rubber wood is suitable for this product

The figure above shows the analysis of feedback from respondents about the suitability of rubber boards for this product. From the analysis, a total of 35.7% (20 people) of respondents answered STRONGLY AGREE. While 37.5% (21 people) among the respondents answered AGREE.

4. Adakah anda menyukai set rekaan papan hiris ini

58 responses

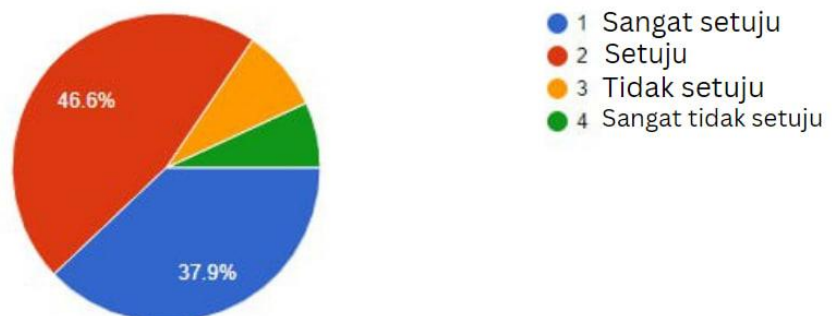

Diagram 8 : Cutting board design set

The figure above shows the analysis of feedback from respondents about the suitability of rubber boards for this product. From the analysis, a total of 35.7% (20 people) of respondents answered STRONGLY AGREE. While 37.5% (21 people) among the respondents answered AGREE. Next, 8.9% (5 people) of respondents did NOT AGREE.

5. Adakah anda berminat untuk tempah dan beli material, rekaan, cadangan

58 responses



Diagram 9 : Buying and booking material

The figure above shows the analysis of feedback from respondents about the suitability of rubber boards for this product. From the analysis, a total of 39.7% (23 people) of respondents answered STRONGLY AGREE. While 32.8% (19 people) among the respondents answered AGREE.

CHAPTER 5

CONCLUSION

5.1 CONCLUSION

In conclusion, this is an important kitchen tool, it is mainly used for slicing cooking ingredients. This wooden slicing board is the best. A slicing board is a very important kitchen tool to use, especially for slicing vegetables. This wooden slicing board is the main tool before the cooking process. Nowadays, many consumers have several purpose-built slicing boards at home. This is intended because here the importance of the slicing board will be emphasized to the user. Therefore, the study found that the most popular use of this slicing board is among housewives, working women, small traders, and students of all levels regardless of young or old age. Therefore, we already tested this product in real scenarios to prevent any user's or respondent's problem can be solved. That's why, this project can be useful to the public.

5.2 RECOMMENDATION

The use of this slicing board for this product is able to reduce the problem because there are two places to place the sliced material as well as the knife slot. Here are some things that are suggested to further improve the study that will be done on the Vegetables Board to find out the level of effectiveness:

- This product can be used as a kitchen decoration for women or consumers like to collect as a kitchen decoration.
- Customers can order Vegetable Boards based on several design options available.

REFERENCES

1. Wikipedia, Kitchen accessed 15 March 2021 from website <http://wikipedia.org/wiki/Dapur>
2. Ikea, Knives and Chopping Board, from the website <https://www.ikea.com/my/en/cat/knives-chopping-boards-15934/>
3. Anonymous, Feb 2023 website <https://educalingo.com/ms/dic-en/chopping-board>
4. Anonymous, 2022 website <https://www.houseofknives.com.au/id/blogs/news/best-kitchen-cutting-boards> <https://www.houseofknives.com.au/id/blogs/news/best-kitchen-cutting-boards>
5. Anonymous. 1982. Malaysian Timbers - Rubberwood. Malaysian Forest Service Trade Leaflet No. 58. The Malaysian Timber Industry Board and Forest Research Institute Malaysia, Kuala Lumpur. 7 pp.
[http://mtc.com.my/wizards/mtc_tud/items/report\(105\).](http://mtc.com.my/wizards/mtc_tud/items/report(105))

APPENDIX 1

7	Draft report 2														
8	Final Report														
9	Log book														
10	Submission Report														

	WORK PLANNING
	IMPLEMENTATION

GANTT CHART WORKING PROCESS

CARTA GANTT : PERANCANGAN DAN PELAKSANAAN PROJEK PELAJAR

SESI : 2 : 2022/2023
 JABATAN: JKA
 KODKURSUS: DCW50243
 TAJUK PROJEK : VEGETABLE BOARD



APPENDIX 1

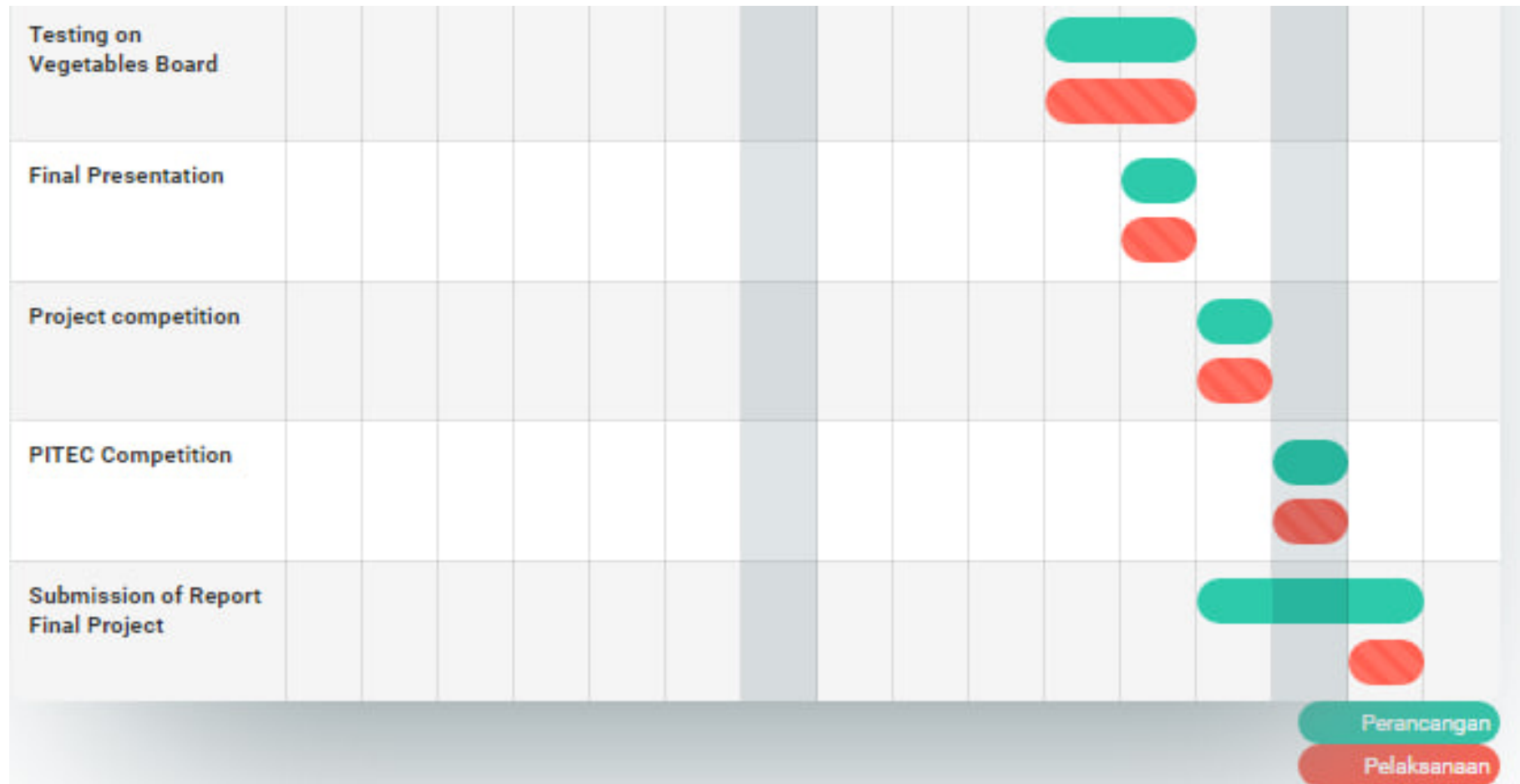

APPENDIX 2

BAHAGIAN A

DATA DEMOGRAFI RESPONDEN

1. JANTINA

LELAKI

PEREMPUAN

BANGSA

MELAYU

CINA

INDIA

LAIN-LAIN

KATEGORI

REMAJA

DEWASA

WARGA EMAS

KATEGORI

REMAJA

DEWASA

WARGA EMAS

PEKERJAAN

SURI RUMAH

BEKERJAYA

PENIAGA

PELAJAR

LAIN-LAIN

[Back](#) [Next](#) [Clear form](#)

APPENDIX 2

ORANG AWAM (PENGGUNAAN)

1. Papan hiris adalah salah satu peralatan yang penting di dapur.

- Sangat tidak setuju
- Tidak setuju
- Setuju
- Sangat setuju

2. Berapa kerapkah anda menggunakan papan hiris dalam tempoh seminggu?

- 1-3 kali
- 4-6 kali
- Setiap hari

3. Adakah kewujudan papan hiris ini memberi manfaat kepada pengguna?

- Sangat tidak setuju
- Tidak setuju
- Setuju
- Sangat setuju

5. Yang manakah ciri-ciri papan hiris yang anda perlukan?

- Mempunyai ruangan meletak bahan yang telah dihiris dan juga pisau.
- Mempunyai reka bentuk yang menarik.
- Mempunyai lubang untuk mengantungkan papan hiris.

6. Adakah anda berminat dengan papan hiris yang mempunyai ruang untuk meletakkan bahan yang telah dihiris dan juga pisau ?

- Ya
- Tidak

Back

Next

Clear form

BAHAGIAN B

SOALAN TAHAP PERSETUJUAN REKA BENTUK DAN PENGGUNAAN

Pilih jawapan :

1. Sangat setuju
2. Setuju
3. Tidak setuju
4. Sangat tidak setuju

Gambar Vegetable Board



APPENDIX 3

SOALAN

1. Vegetable board ini dapat menjimatkan bekas untuk meletakkan bahan yang telah dihiris.

- 1
- 2
- 3
- 4

2. Adakah ruang papan pemotong ini sesuai ?

- 1
- 2
- 3
- 4

3. Adakah rubber wood sesuai dengan produk ini

- 1
- 2
- 3
- 4

4. Adakah anda menyukai set rekaan papan hiris ini

- 1
- 2
- 3
- 4

5. Adakah anda berminat untuk tempah dan beli material, rekaan, cadangan

- 1
- 2
- 3
- 4
- Other: _____

Back

Submit

Clear form