

POLITEKNIK SULTAN SALAHUDDIN

ABDUL AZIZ SHAH

**STUDY OF E-WASTE AS REPLACEMENT MATERIAL
OF COARSE AGGREGATE**

**MUHAMMAD THALHA BIN HAMDAN
08DKA20F1001**

**Laporan ini dikemukakan kepada Jabatan Kejuruteraan Awam sebagai
memenuhi sebahagian syarat penganugerahan Diploma Kejuruteraan Awam**

SESI 1 2022/2023

TABLE OF CONTENT

1.1 DEFINITION OF CONCRETE.....	- 8 -
1.2 DEFINITION OF E-WASTE	- 9 -
1.3. PROBLEM STATEMENT	- 10 -
1.3.1 PROBLEM OF CONCRETE.....	- 10 -
1.3.2 PROBLEM OF E-WASTE	- 10 -
1.4 OBJECTIVES	- 11 -
1.5 SCOPE STUDY	- 11 -
1.7 CONCLUSION.....	- 11 -
2.1 INTRODUCTION	- 12 -
2.2 THE CONCRETE AND E-WASTE.....	- 12 -
2.2.1 Concrete	- 12 -
2.2.2 E-Waste	- 13 -
2.3 COMPRESSIVE STRENGTH	- 14 -
2.4 FLEXURAL STRENGTH.....	- 16 -
2.5 MATERIAL ON E-WASTE.....	- 18 -
2.6 EFFECT OF CONCRETE WHEN MIXTURE WITH E-WASTE.....	- 19 -
2.7 WATER ABSORPTION	- 20 -
2.8 SUMMARY	- 20 -
3.1 INTRODUCTION	- 21 -
3.2 RESEARCH DESIGN	- 21 -
3.3 MATERIAL	- 22 -
3.3.1 E-WASTE	- 22 -
3.3.3 CEMENT	- 23 -
3.3.4 WATER.....	- 24 -
3.3.5 FINE AGGEREGATE	- 25 -
3.4 RESEARCH METHOD.....	- 26 -
3.4.1 MIX PROPORTION	- 26 -
3.4.2 GRINDING	- 27 -
3.5 TESTING METHOD.....	- 28 -
3.5.1 COMPRESSIVE TEST MACHINE (CTM).....	- 28 -
3.6 METHODOLOGY FLOW CHART.....	- 29 -
3.7 GANTT CHART	- 31 -

3.8 CONCLUSION.....	- 31 -
CHAPTER 4 RESULT AND DISCUSSION	- 32 -
4.1 INTRODUCTION	- 32 -
4.2 RESULT FOR 7 DAYS CURING	- 33 -
4.3 RESULT FOR 28 DAYS CURING	- 35 -
4.4 RESULT AND DATA FOR WATER ABSORPTION TEST	- 37 -
4.5 SUMMARY OF RESULT COMPRESSIVE STRENGTH OF CONCRETE	- 38 -
4.6 SUMMARY CHAPTER.....	- 39 -
CHAPTER 5 CONCLUSION AND RECOMMENDATION.....	- 40 -
5.1 INTRODUCTION	- 40 -
5.2 CONCLUSION.....	- 41 -
5.3 RECOMMENDATION	- 42 -
5.4 SUMMARY	- 42 -

AKUAN KEASLIAN DAN HAK MILIK

STUDY OF E-WASTE AS REPLACEMENT MATERIAL OF COARSE AGGREGATE

1. Saya, **MUHAMMAD THALHA BIN HAMDAN (NO KP:020603-10-0691)** adalah pelajar **Diploma Kejuruteraan Awam, Politeknik Sultan Salahuddin Abdul Aziz Shah**, yang beralamat di **Persiaran Usahawan, Politeknik Sultan Salahuddin Abdul Aziz Shah, 40150 Shah Alam, Selangor**.
2. Saya mengakui bahawa 'Projek tersebut di atas' dan harta intelek yang ada di dalamnya adalah hasil karya/ reka cipta asli saya tanpa mengambil atau meniru mana-mana harta intelek daripada pihak-pihak lain.
3. Saya bersetuju melepaskan pemilikan harta intelek 'Projek tersebut' kepada 'Politeknik tersebut' bagi memenuhi keperluan untuk penganugerahan **Diploma Kejuruteraan Awam** kepada saya.

Diperbuat dan dengan sebenar-benarnya diakui)
oleh yang tersebut;)
MUHAMMAD THALHA BIN HAMDAN)
(No. Kad Pengenalan: 020603-10-0691) MUHAMMAD THALHA
BIN HAMDAN

Di hadapan saya, FARIHAH BINTI MANSOR (801026-02-5864)
Sebagai penyelia projek pada Tarikh:) FARIHAH BINTI
MANSOR

ACKNOWLEDGEMENT

First of all, I would like to thank God for giving me space and good health throughout the writing of this report.

I would like to express my gratitude to my family who have given me moral support throughout the completion of this project. Indeed, very strong support has been given by her mother, Pn Azmah Binti Mat Senang and her beloved father. Mr. Hamdan bin Ismail and his beloved family. Unrequited service to the beloved family.

Next to my Project Supervisor, Pn Farihah Binti Mansor for her guidance and guidance throughout the completion of this report from semester 4 until semester 5 (1 year). Infinite thanks also to Nur Najwa binti Khairulanuar, my groupmates, for the cooperation that has been given throughout the completion of this project. It is hoped that the laughter and hardships faced together will be etched in our memories together

Finally, I would like to thank my friends, classmates DKA 5A, Academic Advisors, Pn Herliana binti Hassan and Pn Daliela binti Ishamuddin as well as my school friends and seniors who have helped me and given me strong support until I was able to complete this project especially for Zuhaiqal bin Zunairi.

STUDY OF E-WASTE AS REPLACEMENT MATERIAL OF COARSE AGGREGATE

Muhammad Thalha bin Hamdan, Nur Najwa binti Khairulanuar, Fariyah binti Mansor

¹Jabatan Kejuruteraan Awam,
Politeknik Sultan Salahuddin Abdul Aziz Shah

fariyah@psa.edu.my, 08dka20f1001@student.psa.edu.my , 08dka20f1002@student.psa.edu.my

Abstract

The increasing advancement of technology leads to an increase in electrical and electronic waste known as E-Waste. According to the Department of Environment, the amount of e-waste that was discarded in 2020 is estimated at 1 053 302 tonnes. E-Waste can be categorized into two types, namely E-Waste Industry and Household E-Waste. E-Waste materials include unused or damaged phones, washing machines, televisions, and all appliances that use electrical components. Therefore, this study is to determine the strength of the concrete mix of e-waste as a replacement material as coarse aggregate in the M15 grade concrete mix. In this study, we use a mixture of 1:2:4 as a concrete production material. E-Waste is used as a partial substitute for coarse aggregate where it will be mixed with 3%, 5% and 10%. The tests carried out are compression tests and water seepage rate tests. From the findings of the study, the more e-waste is used, the more the strength of e-waste concrete is increased but it's not reached the minimum strength of M15 concrete grade. In addition, it provides a high rate of water absorption compared to nominal concrete. The 10% E-Waste data, shows the highest compressive strength rate (14.2 N/mm) and the highest water absorption rate (7.67g) among the three percentages of the mixture. Ultimately, e-waste concrete can only be used as a finish and as a non-structural-building material. In conclusion, this study will show how E-Waste disposal can help improve the quality of environmental pollution by mixing in concrete.

Keywords: *E-Waste, Compression Strength, Environment Sustainability, Concrete Material*

Abstrak

Kemajuan teknologi yang semakin meningkat membawa kepada peningkatan sisa elektrik dan elektronik yang dikenali sebagai E-Waste. Menurut Jabatan Alam Sekitar, jumlah e-sisa yang dibuang pada tahun 2020 dianggarkan sebanyak 1 053 302 tan. E-Waste boleh dikategorikan kepada dua jenis iaitu Industri E-Waste dan E-Waste Isi Rumah. Bahan E-Waste termasuk telefon yang tidak digunakan atau rosak, mesin basuh, televisyen, dan semua peralatan yang menggunakan komponen elektrik. Oleh itu, kajian ini adalah untuk menentukan kekuatan bancuhan konkrit e-waste sebagai bahan gantian sebagai agregat kasar dalam bancuhan konkrit gred M15. Dalam kajian ini, kami menggunakan campuran 1:2:4 sebagai bahan pengeluaran konkrit. E-Waste digunakan sebagai pengganti separa bagi agregat kasar di mana ia akan dicampur dengan 3%, 5% dan 10%. Ujian yang dijalankan ialah ujian mampatan dan ujian kadar resapan air. Daripada dapatan kajian, semakin banyak e-waste digunakan, semakin tinggi kekuatan konkrit e-waste tetapi ia tidak mencapai kekuatan minimum gred konkrit M15. Di samping itu, ia memberikan kadar penyerapan air yang tinggi berbanding konkrit nominal. Data 10% E-Waste, menunjukkan kadar kekuatan mampatan tertinggi (14.2 N/mm) dan kadar serapan air tertinggi (7.67g) antara tiga peratusan campuran. Akhirnya, konkrit e-waste hanya boleh digunakan sebagai kemasan dan sebagai bahan binaan bukan struktur. Kesimpulannya, kajian ini akan menunjukkan bagaimana pelupusan E-Waste dapat membantu meningkatkan kualiti pencemaran alam sekitar dengan mencampurkan dalam konkrit.

Kata kunci: E-Waste, Kekuatan Mampatan, Kelestarian Alam Sekitar, Bahan Konkrit

CHAPTER ONE

INTRODUCTION

1.1 DEFINITION OF CONCRETE

Concrete is a combination of cement and aggregates such as sand, water, fine and coarse aggregates. The mixing rate of concrete is very important in the production of quality concrete. Quality concrete can have a positive impact in a construction project. Concrete is a substance with a fairly diverse composition. The aggregate determines the maximum characteristics and workability of concrete. The mechanical properties of concrete are influenced by aggregate properties such as aggregate shape, size, source, crushing type, normal or light or heavy weight aggregate, angularity index, modulus of elasticity, surface texture, specific gravity, bulk density, adsorption and moisture content, cleanliness, soundness of aggregate, bulking of aggregate, thermal properties, and aggregate grading, among others (Varsha Rathore and Aruna Rawat,2019). Concrete is one of the world's oldest and most widely used construction materials, owing to its low cost, wide availability, long durability, and ability to withstand adverse weather conditions. Concrete is a brittle substance with strong compressive but poor tensile strength (Hasan M.Y. Tantawi ,2015). Concrete is a type of aggregate that is bound together with cement to produce strong compressive strength and can support a huge large of the load. The strength of concrete is determined based on the concrete mix and the strength contained and measured in units of N/mm^2 . For example, M15 concrete is concrete that uses a ratio of 1:2:4 and the strength achieved is 15N/mm. The strength of concrete can be measured through compression tests, flexibility tests, water penetration tests and so on. All tests conducted are in accordance with British Standard (BS) procedures.

The physical property of concrete is fire resistance. this is because, when a building experiences a fire, it can accommodatethe fire does not spread to other parts. In addition, the concrete hardens quickly when water is added to the mixture. this matter is important in a construction because in a construction, the uncertainty of the weather will disrupt the construction process. The presence of water in Portland cement will result in the occurrence of two main chemical reaction processes which are the hydrolysis process and also the hydration process. In the hydrolysis process, water (H_2O) will cause dry chemicals in cement such as Calcium Silicate to make two hydrated chemicals. This is shown in the equation below:

$3\text{CaO} \cdot \text{SiO}_2 + \text{water (H}_2\text{O)} \rightarrow \text{xCaO} \cdot \text{ySiO}_2 \text{ (aq)} + \text{Ca (OH)}_2$

(tricalcium silicate (calcium silicate (calcium hydroxide
dry) hydrated) hydrated)

1.2 DEFINITION OF E-WASTE

E-waste is waste or electrical and electronic goods that do not want to be used or that have been damaged. Unattended e-waste can affect human health. E-waste refers to electrical or electronic items that have been abandoned, surplus, obsolete, or broken. Anything with plugs, cords, or electronic components is considered e-waste (electronic waste). Televisions, computers, mobile phones, and any type of home appliance, from air conditioners to children's toys, are common sources of e-waste. The use of electronic devices has proliferated in recent decades, and the quantity of electronic devices disposed of, such as PCs, mobile phones, and entertainment electronics, is increasing rapidly around the world (Roof Wilder et al 2005). Rapid technological progress and inexpensive beginning costs have resulted in a rapid adoption rate. Globally, there is an increasing abundance of electronic trash. several tonnes of e-waste must be disposed of every year (P Asha,2015). Hazardous and inert waste materials from the electronics and electrical sectors are separated into two groups. E-waste, or inert waste, refers to outmoded, discarded, or malfunctioning electrical or electronics devices. E-waste products are extremely difficult to dispose of. (Varsha Rathore and Aruna Rawat,2019).

Technology that is increasing from year to year causes electrical and electronic materials to increase. The development of IR 4.0 to 5.0 affects current technology development. eventually when the technology is no longer used, all this electricity and electronics are thrown away and this is classified as e-waste. For example, the rapid development of smartphones such as Apple from iPhone 15 to iPhone 16 with the development of various updates will influence buyers to buy a new one and then discard the old phone or reduce the phone again.

1.3. PROBLEM STATEMENT

1.3.1 PROBLEM OF CONCRETE

The problem of concrete that may we facing it is the using of natural resources use in mixture of concrete are too high. In concrete 1:2:4 mixture, we use 2 part of sand which is 1m³ sand = 35l so 2m³ sand = 70l. Next, E-Waste concrete give more strength compared to conventional concrete (Rathore & Rawat, 2019). In tension, concrete is brittle and weak. Plain concrete suffers from two flaws: low tensile strength and low strain at fracture (Srinivasa Rao Srinivasa Rao et al., 2010). A cost of sand are too high such as 9.90 dollar/ton as America compare to Malaysia. At Malaysia a range price of RM 37.00/ton.

1.3.2 PROBLEM OF E-WASTE

In recent years, there has been a growing recognition of our environmental impact as a result of our lifestyle, with the need to adopt a more sustainable approach to our consumption habits emerging as particularly important. This trend applies to industrial sectors that have an impact on consumer habits, particularly the electronic industry, where short life cycles and rapidly evolving technology have resulted in increased e-waste volumes. The vast majority of e-waste components end up in landfills. However, their partial recyclability, as a result of their material composition and the unavoidable restrictions in landfills, has led to the development of retrieval techniques for their recycling and re-use, highlighting the importance of e-waste recycling, not only from a waste management standpoint, but also from a valuable materials' retrieval standpoint.

E-waste problem is in Malaysia will generates 24.5 million of e-waste regarding to electric equipment now day keep increasing. Factor of increasing e-waste are household and industry are E-waste estimates from the DOE for television sets, personal computers, and rechargeable batteries increased dramatically from 463,866 metric tonnes in 2011 to 832,692 metric tonnes in 2020. This data is increasing 44% and this data will keep going because of the high use of electric equipment use nowadays.

1.4 OBJECTIVES

The objectives of this research are to develop the ability of concrete when concrete are mixture with e-waste using 3%, 5%, and 10% with the ratio of 1:2:4. Therefore, these are some objectives that to identified the result at the end of research:

- I. To produce a concrete with e-waste as a replacement material of coarse aggregate
- II. To determine the strength of concrete after replace coarse aggregate with crushed e-waste concrete.
- III. To determine the water absorption that absorb concrete of e-waste concrete and compared with conventional concrete.

1.5 SCOPE STUDY

Fine aggregate will be replace by e-waste using ration of 1:2:4 where 1 part. Next, E-Waste will be collected at Department of Environment with proposal paper will be carried out to the Director of DOE Selangor. The E-Waste that using in this study is mobile smartphone. The e-waste concrete will be replace by 0%, 3%, 5%, and 10% with 3 sample of each ratio and result will be taken for 7 days, and 28 days of curing. Concrete will be casting using cube size which is 150mm x 150mm x 150mm for compressive strength. Lastly, the test will be carried out are compressive strength, and water absorption test. The test carried out are to aim the objective of e-waste that are how e-waste can maintain the strength and the concrete with replacement of e-waste can affect the aired in concrete mixture.

1.7 CONCLUSION

At the end of this research, the concrete are testing using compression test and flexural strength to determine the strength of concrete. This research also identify how to reuse the usage of e-waste that keep increasing nowadays.

CHAPTER TWO LITERATURE REVIEW

2.1 INTRODUCTION

The usage of e-waste more increasing days by days. To keep the circular economy among stakeholder, the reuse, reduce and recycle (3R) must be implement to make a sustainability of environment and to develop the Sustainable Development Goals 2030 (SDG 2030). This research are doing to study on the strength of concrete when e-waste will be replace as fine aggregate. Hence, the source to get sand are more difficult due to amount of sand use in construction are highly demand. Also the price of sand are high due to demand of company and some of them must compete to get the sand. So this study will be focus on the how the effective of concrete when it will be replace with e-waste as fine aggregate.

2.2 THE CONCRETE AND E-WASTE

2.2.1 Concrete

Varsha Rathore and Aruna Rawat define the concrete is the object where all the substance are mix together based on material composition. This is where the coarse and fine material are the filler with the additional of cement paste. The ability of concrete and the useful of concrete are depending on the size of aggregate. (Rathore & Rawat, 2019). Concrete are backbone and very important has to be manufactured in large quantity due to demand of infrastructure development. (Raut et al.2018). Inflated concrete exercise may detritus matter scarcity. As a result, suitable constituents must be reinstated in sufficient quantities to meet the equitable of concrete surviving in the field (Alagusankareswari et al., 2016). Concrete have a good strength in terms of compressive, stiffness and durability. But in tension, concrete is brittle and weak. Plain concrete suffers from two flaws which is low tensile strength and low strain at fracture (Srinivasa Rao Srinivasa Rao et al., 2010.). In terms of economy side, Inflation is one of the most serious issues that every country faces. It has become critical to reduce construction costs while maintaining structural strength and durability.

2.2.2 E-Waste

Sunil Ahirwar tells that electronic waste become more increasingly because of the market product on electric equipment keep growth rapidly. People nowadays would rather buy a new appliance than go through the trouble of having an old one repaired (Sunil Ahirwar et al.2016). Non-metal parts in PCBs (printed circuit boards) from e-waste can be recovered and used as an ingredient in concrete (Sagar R. Raut et al. 2018). Hazardous and inert waste materials are the two types of waste materials generated by the electronics and electrical industries. It is extremely difficult to dispose of E-waste materials. Waste materials from other industries, such as fly ash, are used in concrete production. E-waste also are usually disposed in land fill, incineration, reuse, recycling and all of these method are maintaining the high cost and can be hazardous to environment. (Rathore & Rawat, 2019). While, Santhanam define that e-waste problem keep increasing day by day because of production and consumption with the increases of technology nowadays. Informal processing of electronic and electronic waste in developing country may cause serious health and pollution problem. Electronic scrap component such as CRTs (cathode Ray Tube), may contain contaminant such as lead, cadmium, beryllium, or brominated flame retardants. A study of electronic waste with the joint venture Manufacturer Association of Information Technology (MAIT) of India and GTZ of German in 2007, they estimated of electronic was approximately 400,000 tonnes generally from computers, mobile phones, and television only. (Santhanam Needhisan et al 2020).

In Malaysia, the e-waste are define as the e-waste that non useful and categorized as waste schedule waste in First Table under Code 110. (Ministry of Mineral and Environment 2017). According to the Mohamamd Tapir Mapa, e-waste can be pollute such as Pb, Sg, Hg, Cd, Ni, Polybrominated Diphenyl Ethers (PBDEs) and Polychlorinated Biphenyls (PCBs). The main factor why e-waste become increasingly are from industry and home usage. For today, the constitutional only focuses on industry e-waste on disposal method of e-waste but there no other law are enforce for home e-waste. So this is the reason why the home-waste are keep increasing now days. (Mohammad Tapir Mapa et al. 2018).

E-waste also known as electronic waste. It is any electronic product or product containing electronic components that has reached the end of its usable life cycle. E-waste can be divided into two main types which are from industrial sector and household e-waste. By MarketWatch in 2018, consumers replaced their mobiles every 15 months. Nowadays, people would prefer to purchase a new appliance rather than deal with the hassle of having an old one repaired. (Sunil Ahirwar et al. 2016). Example of e-waste which is mobile phones, tablets, laptops and others. This is because the proliferation of digital devices is becoming a problem to the world in future. This is because e-waste contains dangerous chemicals such as cadmium, lead, lead oxide, antimony, nickel and mercury. Therefore, can harm the health of humans include can pollute the surrounding environment which is the rivers, lakes, and seas and can release toxic gases into the atmosphere that can harm ecosystems

2.3 COMPRESSIVE STRENGTH

Concrete's compressive strength is defined as its ability to withstand loads before failing. The compressive strength test is the most important of the many tests performed on concrete because it provides information about the concrete's properties. (Pijush Samui et al. 2020). Sagar R. Raut from table 2.1 show their research on Experimental Study on Utilization of E-Waste in Cement concrete found that the addition mixture 15% with coarse aggregate replace by e-waste is the good ratio within 7 days, 14 days and 28 days after sample taken by that day (Sagar R. Raut et al. 2018). Varsha Rathore and Aruna Rawat on table 2.2 shows the study e-waste partially replace with coarse aggregate with ratio of 1: 1.82: 3.43 and 15% with different size. (Varsha Rathore et al. 2019). Otherwise, in K. Alagusankareswari study in e-waste replacement of fine aggregate shows that the more rate of percentage of e-waste mix with concrete, the strength come to decrease. (K. Alagusankareswari et al. 2016). Meanwhile, other studies of concrete with additional of other substance shows the good results. According to the Chandramouli K said that all the grade of concrete M20, M30, M40, and M50 shows that percentage of concrete increase when glass fibre are added by 0.03% in all mixtures. (Chandramouli. K et al. 2010). In other research, Shadheer Ahameer said that the various type of natural fibres with the different of addition of content for grade M20 and M25 are increases the strength. (Shadheer et al. 2020)

Meanwhile, other studies of concrete with additional of other substance shows the good results. According to the Chandramouli K said that all the grade of concrete M20, M30, M40, and M50 shows that percentage of concrete increase when glass fibre are added by 0.03% in all mixtures. (Chandramouli. K et al. 2010). In other research, Shadheer Ahameer said that the various type of natural fibres with the different of addition of content for grade M20 and M25 are increases the strength. (Shadheer et al. 2020).

The ability of a material or structure to support loads on its surface without cracking or deflecting is known as compressive strength. When a material is compressed, its size tends to decrease, and when it is stretched, its size elongates (Gopal Mishra, 2020). Compressive strength commonly need to achieve 15MPa (2200 psi) to 30MPa (4400 psi) for construction in commercial and industrial structures. Lakshmi and Nagan (2010) found that strength shows decreased when e-plastic content was more than 20%. Studies shows that e-waste can be used in concrete but not to strength on load structures. Therefore, concrete that contains e-waste material can be used in effectively as lightweight concrete. Lightweight concrete is a very versatile material for construction which is in a range of technical, economic and environment that can enhance and provide advantages to became a dominant material for construction in the new millennium. In other studies, by Arora and Dave (2013) experiments done shows that the increase in compressive strength by 5%. In this study, we can look through from the compressive strength that have been made in the laboratory.

Addition of ewaste (%)	Day		
	Result (N/mm ²)		
	7	14	28
0	9.72	18.2	28.65
5	9.86	18.45	30.2
10	10.2	18.8	31.6
15	11.6	19.2	31.7
20	9.81	18.0	26

Table 2.1: Compressive Strength

Addition of ewaste (%)	Size (mm) Result (N/mm ²)		
	< 10	10-15	20
0	25	25	25
5	23	31	33
10	20	33	34
15	18	33	34
20	16	25	26
25	16	22	23
30	15	16	17

Table 2.2 Compressive Strength based on particle size

2.4 FLEXURAL STRENGTH

The flexural test indirectly evaluates the tensile strength of concrete. It assesses the ability of an unreinforced concrete beam or slab to withstand bending failure. Based on Aruna studies, it shows in table 2.4 shows that 15% of e-waste as replacement of coarse aggregate with different size of coarse aggregate. (Varsha et al. 2019). S. Sandeep Kumar in his studies that shows in the table 2.5 shows that e-waste as fine aggregate are decrease when the more e-waste added in the mixture (Sandeep Kumar et al. 2016) .

In other research such as natural sugarcane bagasse slightly increased flexural strength by 3%. It stated that when raw jute is applied to concrete with 1 percent cement weight, the flexural strength of the concrete cube improves, and with the addition of 4.5 percent adjusted jute, the flexural strength grows. Fibre was used in the concrete blend at percentages of 3%, 5%, and 7% (by cement weight). The primary effect of using concrete is to increase the bend modulus, as a participant makes the concrete work more effective. (Shadheer Ameer et al. 2020). Other research in study of glass fibres shows that positive result when the percentage of glass fibre increase in concrete mixture compared to nomical cube. (Srinivasa Rao. P et al. 2010). Figure 5 shows the result.

Addition of ewaste (%)	Size (mm) Result (N/mm ²)		
	< 10	10-15	20
0	3.5	3.5	3.5
5	3.2	3.8	4
10	3.1	3.9	4
15	3	3.9	4.1
20	2.8	3.6	3.7
25	2.8	3.3	3.4
30	2.7	2.8	2.9

Table 2.3: flexural strength on E-Waste replacement Coarse Aggregate.

Concrete Type	Flexural Strength, N/mm ²
Control Mix	5.60
E10	4.67
E20	3.33
E30	3.20

Table 2.4: The flexural strength of the concrete

2.5 MATERIAL ON E-WASTE

According to the Adnan Omar, e-Waste is a broad term that encompasses all white goods, consumer and business electronics, and information technology hardware that has reached the end of its useful life. (Adnan Omar et al. 2010). The w-waste such as discarded cellphones, cameras, CD Players, TVs, Radios, Drillers, fax machines, and all the electric equipment that does not use are classified as e-waste. PVC in wire coatings and cables, (2-ethylhexyl) phthalate (DEHP), diisononylphthalate (DINP), butylbenzyl phthalate (BBP), DIDP (diisodecyl phthalate), and dibutyl phthalate are examples of phthalates (DBP). Flame retardants include Polybrominated diphenylethers (PBDEs) are flame retardant additives widely used in plastic casings of electronic equipment's and foams. (Sivakumaran S. 2013). In other studies, Fionna George said that e-waste can be categorized into two which in industries waste and household waste.

Meanwhile, Salmabanu Lahar on the article of Potential Application of E-wastes in construction industry define that e-waste are the useless junk that contain the "Electronic Waste" or E-Waste" that to be recycle, resalable, salvageable, disposable, reusable, restorable. Every year, there have a lot of e-waste are to be dumped mostly nearby land contributing to environmental pollution. The material of e-waste component may include CPUs that potentially harmful such as Cadmium, Lead, Beryllium, or Brominated flame retardants. E-waste contains about the electronic device that have electric or electronic equipment such as mobile phone, machine, refrigerators, television or other things that involving the electricity, electric, and electronic. The chemical substance contain in mobile smartphone are mercury that contain in battery phone. Cadmium, Tin, Aluminium, Copper are places at PCBs boards. Moreover, Polychlorinated Biphenyls are places at capacitor and transformers. The Germanium are in Transistorized Electronic. While, Silicon are the material substance for transistor. (Salmabanu Luhar et al 2019)

2.6 EFFECT OF CONCRETE WHEN MIXTURE WITH E-WASTE

According to the Krishna Prasanna, a trial study was conducted to justify the use of electronic waste in concrete as an incomplete substitution of fine total as well as coarse total in concrete with a percentage replacement ranging from 0% to 20%, i.e. (5%, 10%, 15%, and 20%) and conventional specimens were also prepared for M30 grade Concrete without the use of E-waste aggregates. At the end of the result, he discovered that using E-waste aggregates results in the formation of concrete with a lower weight than conventional concrete (P.Krishna Prasanna, et. al. 2017).

The other of researcher, Ashwini investigated the use of E-waste plastic particles as coarse aggregate in concrete with percentage replacements ranging from 0% to 10%, 20% to 30%, and 30% on the strength criteria of M20 concrete with a w/c ratio of 0.5. At the end of the result, they concluded that the addition of plastic to concrete fails in terms of strength. Plastic, on the other hand, can be used to replace some of the aggregates in a concrete mixture in order to reduce the unit weight of the concrete. This is beneficial in the production of lightweight concrete, such as concrete panels used in facades (Ashwini Manjunath B T et al. 2016).

K. Hamsavathi in their research that Cathode Ray Tube Panel Plastics E-Waste as coarse aggregate in their conclusion show that e-waste is viable alternative material for coarse aggregate in concrete that shall be non-structural application. Hence, in their studies also show addition of e-waste with 15% delivers excellent compressive strength and flexural strength but the addition might be decremental load. Their study also show re-use e-waste plastics can affect the lowered density of concrete.

2.7 WATER ABSORPTION

(Feldman and Sereda, 1968) proposed absorption is the process by which molecules of substances bind to the surface of concrete either through physical bonds or as a result of chemical bonds. To determine the amount of water absorbed under particular circumstances, water absorption is required. The type of plastic used, the additives utilised, the temperature and the duration of exposure are all factors that affect water absorption. The data indicate how the materials operate when it is wet or humid. For water absorption test rates of 0%, 3%, 5% and 10% are 2.3, 2, 5.73 and 7.67 respectively. The data obtained show that the rate of water absorption is increasing according to the adding e-waste material. This factor may be due to air condition which can caused the highest water absorption to concrete. According to Maritime Code BS6349 specifies that water absorption should not exceed 3% or 2%. In addition, the curing condition can also cause the concrete surface to lose hydration. Therefore, the curing method can also affect this result. The porosity can be decreased by properly curing, which can also lower the rate of moisture loss and provide a constant source of the moisture needed for hydration (Alamri, 1988).

2.8 SUMMARY

Based on the literature review had be done, this project will include the Circular Economy to make sustainable environment better and safe the surrounding and reduce the environement polluted due to increasing of e-waste. Also in this chapter, there have include how e-waste can effect the strength material of concrete. This study will focus on how the concrete with mixture 1:2:4 can effect the strength of concrete and the how the water can effect the concrete when e-waste are partially replace for coarse aggregate. This is study are based also are focuses on recycle material that will be generate every year due to the increasing electronic waste

CHAPTER THREE

METHODOLOGY

3.1 INTRODUCTION

With the present age of development, many constructions will be built to reach a developed country. Therefore, with the availability of e-waste concrete can reach the latest era because of its many advantages over other conventional concrete. Thus, the purpose of this study is to test the workability and strength of e-waste concrete to be done with several mixtures namely water, coarse aggregate and e-waste as to replace fine aggregate. Tests against this will be performed on the 7th, 14th and 21st days. Therefore, this methodology will show the mix of materials, tests, designs and results to produce e-waste concrete.

3.2 RESEARCH DESIGN

This e-waste concrete will be designed to standard concrete size which is M15 grade 150mm x 150mm x 150mm for compressive strength and the same cube will be tested for water absorption test. In this study, we will have three specimens which consists of e-waste of 3%, 5%, 10% as replace material of coarse aggregate. This cube will be put in the mould with the size pf 150 mmx 150mm x 150mm.

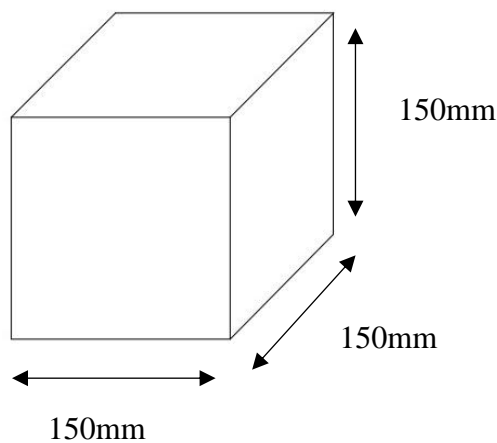

3.3 MATERIAL

3.3.1 E-WASTE

E-waste or electronic waste is created when an electronic product is discarded after the end of its useful life. The rapid expansion of technology and the consumption driven society results in the creation of a very large amount of e-waste. E-waste is classified into two categories based on its source of generation: industrial e-waste and household e-waste. E-waste will be used as much as 3%, 5%, 10%, to test its strength level in concrete. This e-waste source will be available from the Thanam Industry Sdn. Bhd. Also, we are collected this e-waste from EARTH Company. For this study, we use communications and information technology devices that one of the categories of e-waste materials such as cell phone and smart phone. The material inside the smartphone are Transistor, Capacitor, Motherboard, Chip Set, LCD Screen, Fibre Plastic, Phone Speaker, Phone Camera and a lot wire.



Figure 3.1 Handphone E-Waste



Figure 3.2 E-Waste mixture with concrete

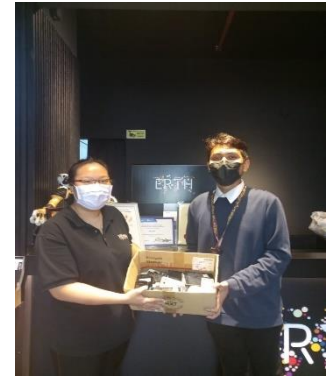

Figure 3.3 E-waste collected at EARTH

3.3.2 COARSE AGGREGATES

Coarse aggregates are irregular and granular materials used to make concrete, such as sand, gravel, or crushed stone. Coarse is usually found naturally and can be obtained by blasting quarries or crushing them by hand or with crushers. In this study the particle size of coarse aggregates that will use is 20mm following the standard size of concrete. The best aggregate is the angular shape because can create the strong bond or interlock with other material for cement paste. Coarse aggregates are the particles that retain in a 4.75 mm sieve. According to the Santhanam Needhidasan, the coarse aggregate are analysis by doing sieve analysis according to the IS 383:1970 and IS 10262:1982- Method of the test (Santhanam et al. 2020). We will collect by doing the sieve

analysis to determine the properties of coarse aggregate to mix with the concrete. The distribution of aggregate particles by size within a sample is determined using a sieve analysis or gradation test. This data can then be analysed to evaluate whether or not the design and production requirements are fulfilled. The coarse aggregate are taken backside of Brickwork Workshop at Polytechnic Sultan Salahuddin Abdul Aziz Shah. After that, the coarse aggregate are weighing according to the experiment analysis.



Figure 3.5 Coarse Aggregate



Figure 3.5 Coarse Aggregate at back of Brick Workshop

3.3.3 CEMENT

A cement is a binder, a substance used for construction that sets, hardens, and adheres to other materials to bind them together. Cement is seldom used on its own, but rather to bind sand and gravel together. This cement are taken from concrete laboratory under supervise this supervisor project and person-in-charge for lab. The usage of this cement use are 4000g based on. According to the S. Bharani the physical properties of cement bt the standard value as per IS 12, 269, Setting time initial minimum are 30 and setting time final are maximum 600. According to J.J Brookes, Portland Cement is the name given to a type of cement that mixes lime and argillaceous materials or materials that have silica, alumina and iron and burns them at a scorched temperature and then grinds the scorched stone (J.J. Broke et al 1987).

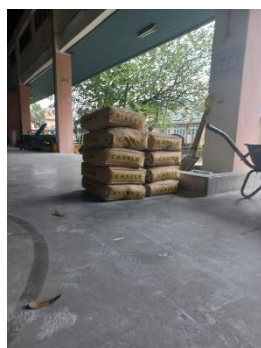

Figure 3.6: Cement in packaging

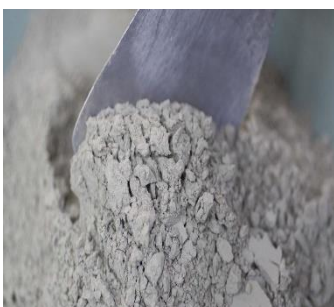

Figure 3.7 Cement outside the packaging

3.3.4 WATER

The water-to-cementitious-materials ratio in concrete is critical for determining its strength and durability. Because the cement pastes affixes promptly and adequately to the wet surface of the aggregates as opposed to a dry surface, water is required to soak the surface of the aggregates to develop adhesive qualities. Water ratio is very important in concrete production. This is because water quality affects the strength and texture of the concrete in construction work. Moreover, The quality of water is very important because impurities in it can interfere with the cement hardening process and can result in adverse effects on the strength of concrete or can cause pooling on the concrete surface (J.J Brooks, 1978). In addition to using water in the concrete mix, it is also needed in the preparation of mortar, curing work and others. The ratio of water in the concrete is commonly 1m^3 of concrete is 150 litres.



Figure 3.8: Water in the cylinder measurement

3.3.5 FINE AGGEREGATE

Fine aggregates are any natural sand particles extracted from the ground by the mining process. Fine aggregates are made up of natural sand or crushed stone particles that are 14 inches in diameter or smaller. In this study, we replace the source material of fine aggregate with e-waste. we will see the results of concrete strength with the addition of e-waste materials. Aggregate shall be composed of naturally occurring (crushed or uncrushed) stones, gravel, and sand, or a combination of these materials. They must be hard, strong, dense, and long-lasting, free of veins and adherent coating, and free of harmful amounts of disintegrated pieces, alkali, vegetable matter, or other harmful substances. Flaky and elongated pieces should be avoided whenever possible. Aggregate that passes the 4.75-mm IS Sieve and contains no coarser material is permitted as fine aggregate (Santhanam et al 2020).



Figure 3.7 Fine Aggregate

3.4 RESEARCH METHOD

3.4.1 MIX PROPORTION

Table 3.4. shows the specifications of the mix value of concrete with the addition of e-waste material of 3%, 5%, and 10%. So far, the mix is according to:

Material	0%	3%	5%	10%
Cement	1000 g	1000 g	1000 g	1000 g
E-waste	0	120 g	200 g	300 g
Fine Aggregate	2000 g	2000 g	2000 g	20000 g
Coarse Aggregate	4000 g	3880 g	3800 g	3600 g

Water Cement Ratio: 0.55

For Grade M15 it using ratio 1:2:4 for one cube. So:

1 Cement = 1 kg of Cement

2 Fine aggregate = 2 kg of Fine Aggregate

4 Coarse Aggregate = 4 kg of Coarse Aggregate

H₂O = 0.55 l

3.4.2 GRINDING

By Corrosionpedia says hard materials can be ground down to size or tools can be sharpened using this procedure, which is usually done in stages. After crushing, grinding is done to generate finished goods with the specified fineness. The final fineness, for instance, relies according to how finely the desired mineral is dispersed when the mineral ore is crushed to a given and then ground to a powder. Depending on the procedure being used, grinding can be done either wet or dry. However, for dry grinding, the materials may first need to be dried in cylindrical, rotary dryers.

This study will use e-waste component material to replace the partially source as a coarse aggregate. Thus, the method that needs to be done is by crushing and grinding the e-waste material into smaller particles that pass the size of 10mm, 20mm, 40mm in sieve shaker also need to be in angular shape and flaky shape and this e-waste will be determine in flakiness and elongation test equipment do determine the size of e-waste.

3.5 TESTING METHOD

3.5.1 COMPRESSIVE TEST MACHINE (CTM)

The maximum compressive load a material can withstand before fracturing is determined via a mechanical test. Compressive strength machine are the machine that ability to test a structure when load tending to elongate. This machine will be use after seven days or 28 days of curing, these specimens are evaluated on a compression testing equipment. Specimens should be loaded gradually at a rate of 140 kg/cm² per minute until they fail. The compressive strength of concrete is calculated by dividing the load at failure by the area of the specimen. This machine test will be do at RTL Laboratory Sdn. Bhd. With existing technology, this compression machine can determine the strength, density, and load rate that can be accommodated at one time. A compression testing machine is a type of universal testing machine (UTM) that is specially designed to determine the strength and deformation behaviour of a material under compressive (pressing) load. A compression tester is typically made up of a load cell, crossheads, compression test tools, electronics, and a drive system. Testing software is used to define machine and safety settings as well as store test parameters specified by testing standards such as ASTM and ISO. It is critical to consider the material to be tested as well as the standard(s) that must be followed when selecting compression test equipment.



Figure 3.7 Compression Test Machine

3.6 METHODOLOGY FLOW CHART

Chart 3.1 shows a flow chart throughout this study was implemented phase 1

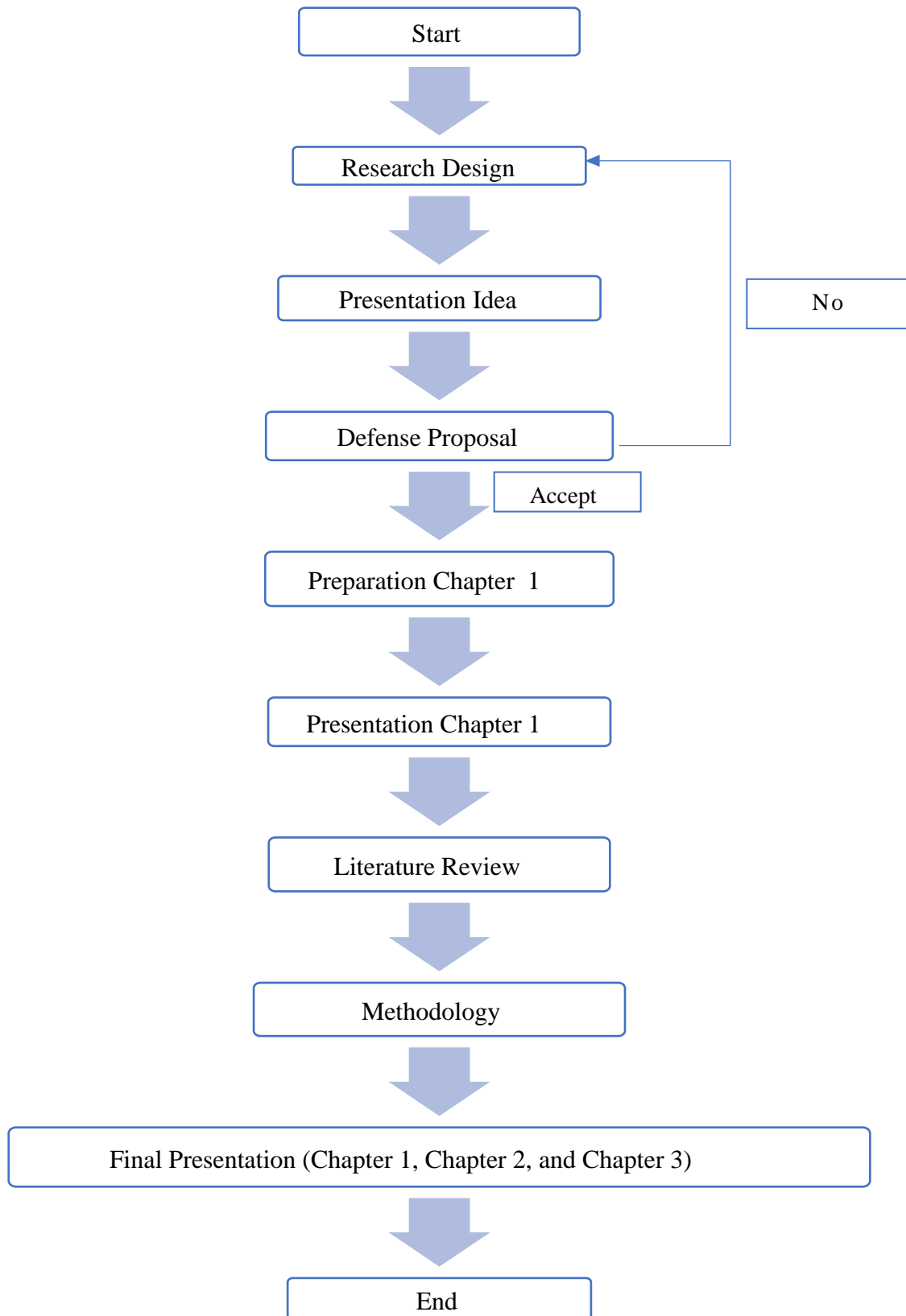
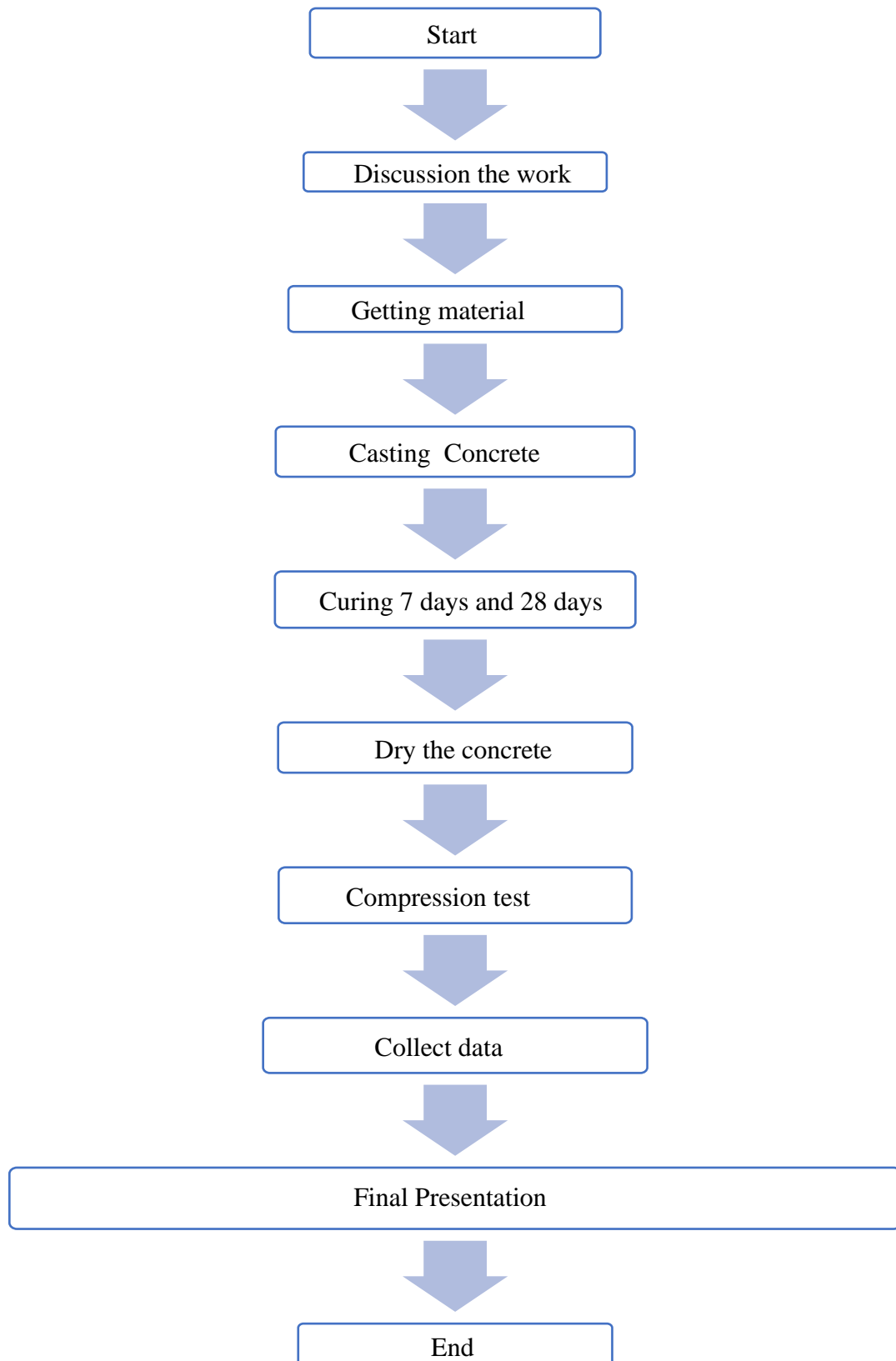

Chart 3.2 show flow chart through this study was implement



3.7 GANTT CHART

DCC 40181 FINAL YEAR PROJECT																	
STUDY ON CONCRETE WITH E-WASTE AS REPLACEMENT MATERIAL AS FINE AGGREGATE																	
CIVIL ENGINEERING DEPARTMENT																	
SESSION	WEEK	SESSION 2 2021/2022															
		W1	W2	W3	W4	W5	W6	W7	W8	W9	W10	W11	W12	W13	W14	W15	W16
DISCUSSION SESSION																	
DISCUSSION ON THE PROJECT TITLE																	
CHOOSING THE PROJECT TITLE																	
PREPARATION FOR DEFEND PROPOSAL																	
DEFEND PROPOSAL																	
DISCUSSION ON LITERATURE REVIEW																	
PRESENTATION PROGRESS (TOPIC 1 INTRODUCTION)																	
DISCUSSION ON PREPARATION OF METHODOLOGY																	
PRESENTATION FINAL PROPOSAL																	
SESSION	WEEK	SESSION 1 2022/2023															
		W1	W2	W3	W4	W5	W6	W7	W8	W9	W10	W11	W12	W13	W14	W15	W16
LABORATORY SESSION																	
PREPARATION THE MATERIAL																	
CONCRETE CASTING																	
CONCRETE TESTING																	
ANALYSIS OF CONCRETE RESULT																	
FINAL PRESENTATION																	

Table 3.7 Gantt Chart for Final Year Project

3.8 CONCLUSION

Based on all the material that used in this project, all are the material are easily to get. To determine the strength, the test that involved are compression test and to determine the bending moment, the test are flexural strength. Moreover, to complete this project, it use 14 weeks during the academic session 1 2022/2023.

CHAPTER 4

RESULT AND DISCUSSION

4.1 INTRODUCTION

This chapter will be focusing on the data and result that have been completed after concrete curing 7 days and 28 days. This data have be collected after doing the compression test and water absorption test. This analysis will be perform by table and graphs to show the differentiation of result when e-waste are mixed with concrete using ratio 1:2:4. The percentage of coarse aggregate use in this study are 3%, 5%, and 10%. The objectives of this study are to determine the strength of concrete when e-waste are replace as partial replacement of coarse aggregate. This study also are to determine the water absorption test after the concrete are casting after one day sinking. The total of this concrete casting are 24 cube which is show in chapter 3 methodology. In this study, a concrete grade M15 are pointed according to the IS 10262:2009 method. The specimen of cube test are 150mm x 150mm x150mm. The test are conducted at Reliable Testing Laboratory Sdn. Bhd (RTL Laboratory). The testing are using Compression Test Machine (CTM). The overall of temperature are along this testing are 29°.

4.2 RESULT FOR 7 DAYS CURING

Addition of e-waste (%)	Result (N/mm ²)			Average (N/mm ²)
	Reading			
	1	2	3	
0	16.11	16.15	16.11	16.12
3	12.29	10.29	12.00	11.53
5	11.45	11.37	11.94	11.57
10	11.21	11.92	11.66	11.60

Table 4.1: Compression test for 7 days curing

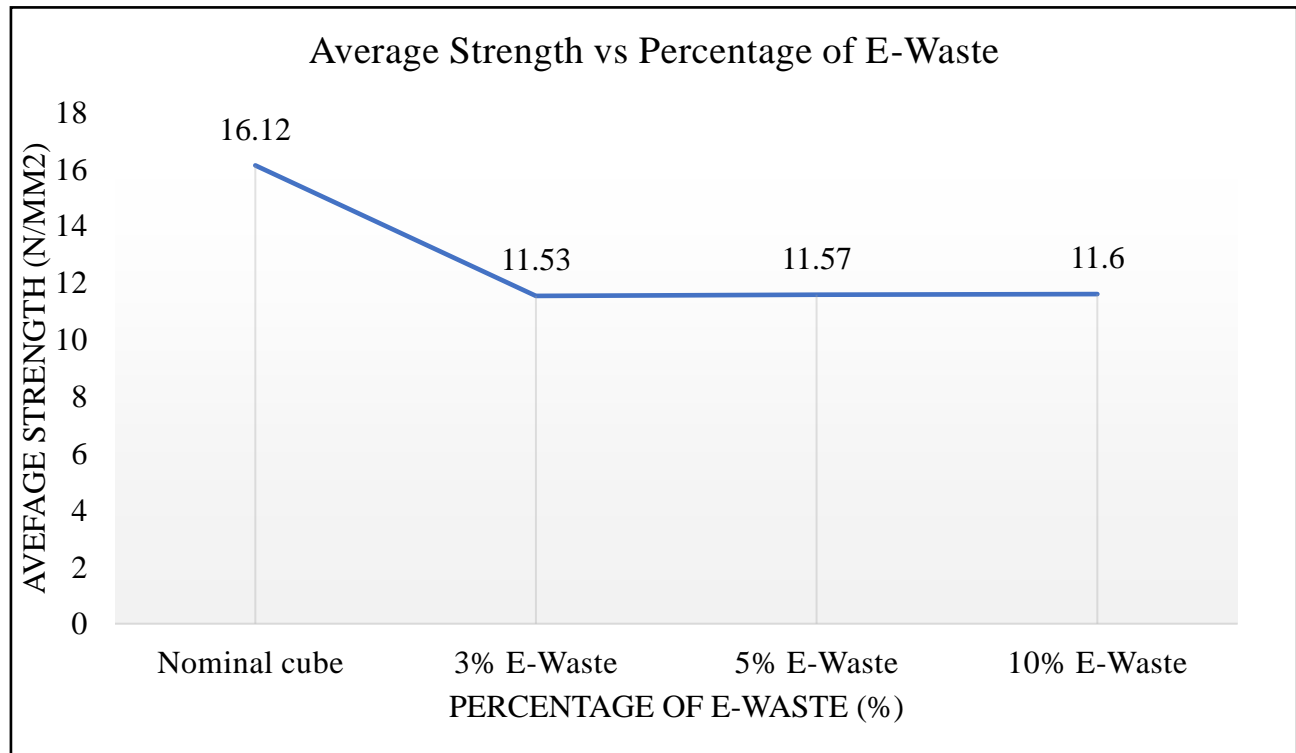

Chart 4.1: Compression Test for 7 days curing

The compression test are to determine the strength, ultimate load, and density of concrete when load are applied on the specimen. There are three cube on each concrete to determine the average of concrete reading. Compression test Table 4.1 show the data for 7 days curing for compression test according to the e-waste that have been partial replacement of concrete mixture. For 0% of e-waste or nominal cube, it shows that the average result are 16.12 N/mm². For 3% of e-waste, the average result are 11.53 N/mm. the 5% of e-waste, the average result are 11.57 N/mm. Lastly, the 10% of e-waste are 11.60 N/mm. The data shows the increasing strength of concrete when the percentage of e-waste are added in the mixture. From the table, it can observed the maximum compressive strength for 7 days concrete are 10% replacement of e-waste as coarse aggregate. Based on chart 4.1, the chart show that the strength of concrete are increasing statically and range of differentiation between concrete e-waste are 0.2-0.3 N/mm². In conclusion, the e-waste concrete with grade M15 can be used a non-structural building such as fence.

4.3 RESULT FOR 28 DAYS CURING

Addition of e-waste (%)	Result (N/mm ²)			Average (N/mm ²)
	Reading			
	1	2	3	
0	16.11	16.15	17.32	17.32
3	12.25	12.07	12.53	12.83
5	13.62	12.20	12.41	12.74
10	14.40	13.91	14.28	14.20

Table 4.2: Compressive Strength for 28 days curing.

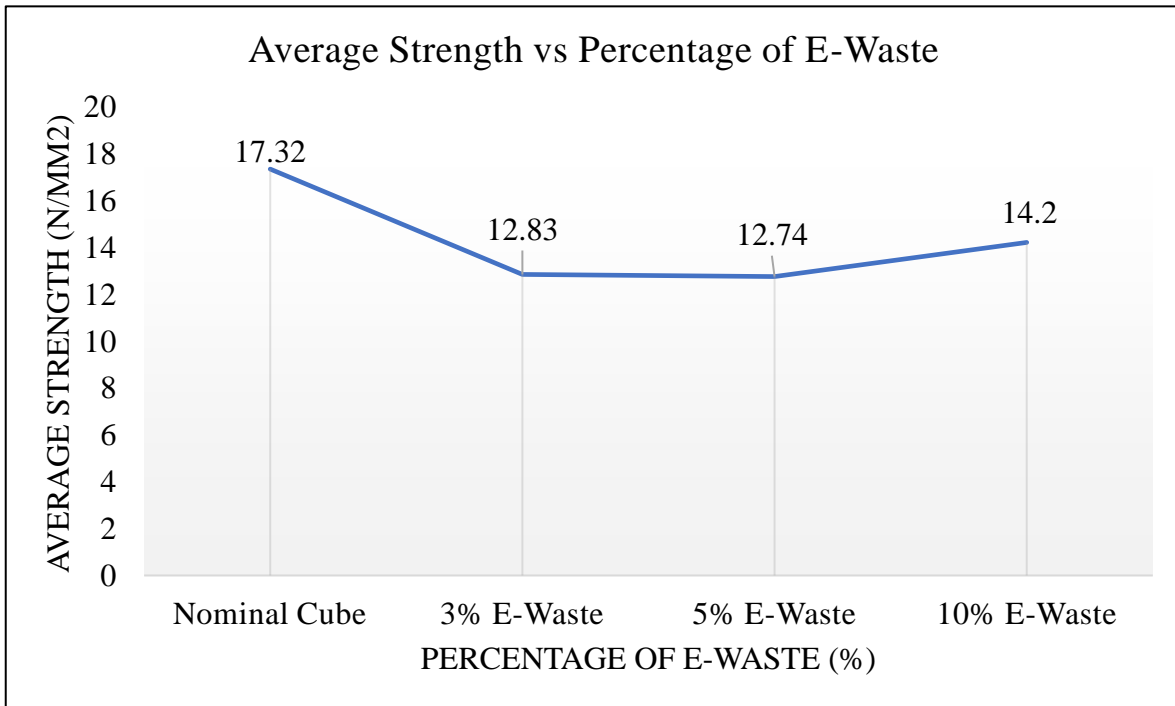

Chart 4.2: Compressive Strength for 28 days

Table 4.2 shows the compressive strength of 28 days concrete curing. The following result as show in the table. For 0% of e-waste, the strength are 17.32 N/mm. Next, when 3% of e-waste are added, the average strength of concrete are 12.83 N/mm. it show the increasing compare to 7 days curing. But it still not reach the standard nominal strength of grade M15. Meanwhile, the 5% of e-waste are replace, the average strength are 12.74 N/mm. It show the increases compare to the 7 days curing result but it show the decreases of strength compare to 3% of e-waste. Lastly, when 10% of e-waste are replace in concrete mixture, the result are 14.20 N/mm. Compare to 7 days curing result, it shows the increases strength but it also not reach the minimum requirement of M15 grade concrete. Based on chart 4.2 show the increasing of strength of 1.98 N/mm² but its not reach the minimum of grade M15 concrete. Based on the analysis strength of the 28 days curing concrete, it shows that the concrete are suitable for non-structural building such as fence or as a finishes in construction work.

4.4 RESULT AND DATA FOR WATER ABSORPTION TEST

Addition of e-waste (%)	Mass (g)		Difference between dry and wet concrete (g)
	dry	wet	
0	7287.07	7290	2.3
3	6635.07	6637	2
5	7070.73	7075	5.73
10	6655.67	6662	7.67

Table 4.3: Data for water absorption test

Water absorption test are required to soak the concrete and collect the result after 1 days soak in the water tank. For the 0% of e-waste, the dry concrete are 7287.07g and dry are 7290g. The difference between dry and wet are 2.3g. Meanwhile, the 3% of concrete, dry concrete are 6635.07g and wet concrete 6637g. The difference between 2 type of concrete are 2g. for the 5% of e-waste, the dry concrete 7070.73g and and wet concrete are 7075g and the difference are 5,73g. Lastly for 10% of e-waste, the dry concrete are 6655.67g and wet concrete are 6662g and the difference are 7.67g.

4.5 SUMMARY OF RESULT COMPRESSIVE STRENGTH OF CONCRETE

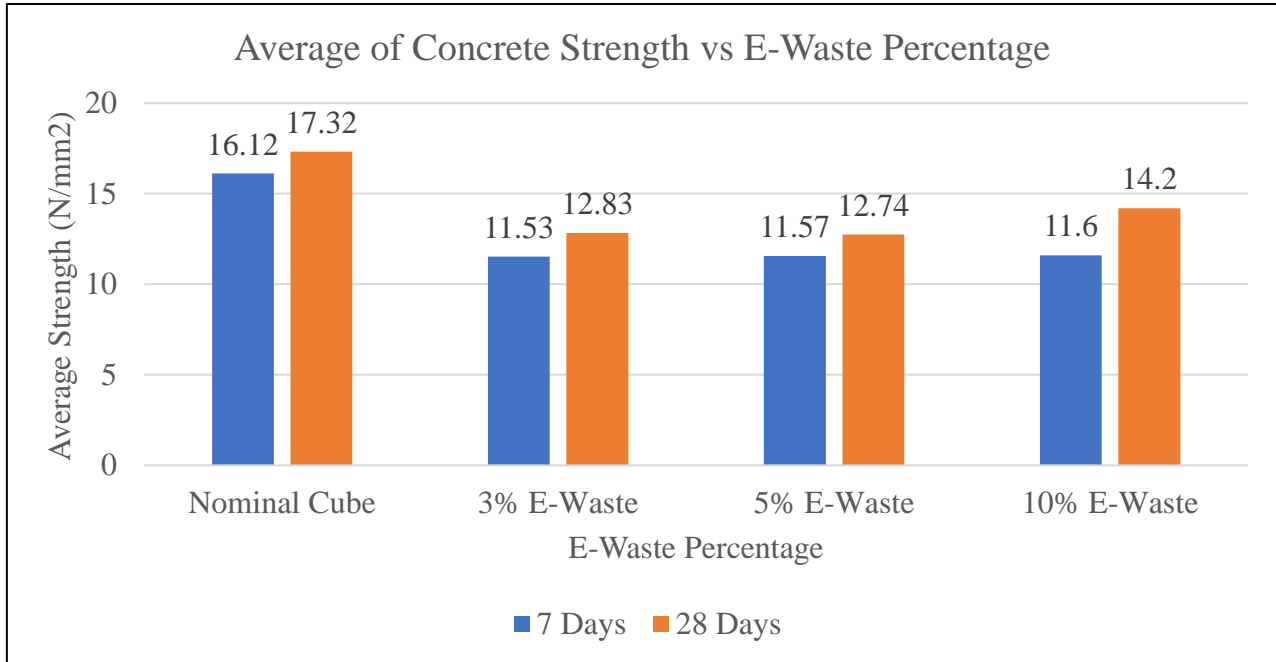

Figure 1 Chart 4.3: Compressive Strength result summary

Based on the chart 4.3, it shows the average of strength and e-waste percentage in replacement of the concrete mixture. For the 3% E-waste it show the different between 7 days and 28 days are 5.33% with the different of 1.3 N/mm². Next for 5% E-Waste, the increasing of concrete are 4.8% with the different are 1.17 N/mm². And lastly, the 10% of E-waste concrete are 10.08% increasing with different with the different of 2.6 N/mm². From the data, it show the increasing of concrete strength but its not exceeding 15 N/mm². After all, there have the discussion to determine the problem and the conclusion are show in chapter 5.

4.6 SUMMARY CHAPTER

In summary, the data has been collected after casting the concrete 7 days and 28 days. The testing of the compressive strength has been done at RTL Lab Sdn. Bhd and Concrete Laboratory, Politeknik Sultan Salahuddin Abdul Aziz Shah. This data are collected based on the objectives of this study which is to determine the strength of e-waste concrete after partially added in concrete mixture to replace coarse aggregate. Meanwhile, we also collected the water absorption test of this concrete do determine the absorption of water after partially added e-waste in the mixture. This water absorption test are required to do to determine the aired hole in concrete mixture. With all the data that have been collected, we are able to do discussion and conclusion of this study.

CHAPTER 5

CONCLUSION AND RECOMMENDATION

5.1 INTRODUCTION

This topic will discuss the research that has been carried out and the data that has been shown in chapter 4. In general, this research is about e-waste mixture as a partial replacement material for concrete mixture. However, inside the e-waste also has chemicals that can bind the bond in the concrete. In addition, in this chapter too, it will tell the conclusion of the project and whether this material is suitable in construction or finishes or relevance in civil engineering. Roughly, this study uses concrete M15 with a mixture of 1:2:4 in the production of concrete. Next, this study also demands to see the compressive strength that can be compressed by this e-waste concrete in the size of 150 mm x 150 mm x 150 mm. In addition, this study is also seen to determine the rate of water infiltration in concrete to determine the mass of water that has been absorbed in concrete. Analysis and discussion have been carried out in chapter 4 and this chapter will tell the recommendations and improvements that need to be made to produce mature concrete to reach grade M15.

5.2 CONCLUSION

In conclusion, this study has been successfully produced by using grade M15 with a minimum strength rating of 15n/mm. The objective of this study was to find alternatives other than coarse aggregate in the production of concrete. With the advancement of technology, the electrical and electronic waste is increasing. This not only endangers the surrounding community, but it will increase the level of radiation especially in the environment. In addition, the objective of this concrete is also to determine the compressive strength of concrete when e-waste concrete has been produced. The compressive strength of concrete was carried out and the results were, 10% e-waste almost reached a rate of 15 n/mm². Because there are some defects during the production process such as inaccurate water readings, it will affect the compression rate of the concrete produced. In addition to that, errors in reading tools and errors in weighing tools also affect the mix rate in the concrete produced. Finally, the objective of this study was also carried out to find out the rate of water infiltration in the produced concrete. According to A.M. Neville, a simple method to determine the rate of water infiltration is to perform a water infiltration test (Neville et al 1987). Overall, all three objectives have been achieved. However, improvements need to be carried out because there are some problems during concrete production and after concrete production. This study was conducted to create sustainable ecosystem stability and a good circular economic in addition to the use of increasingly sophisticated technology and electrical and electronic tools that are increasingly used. This study was conducted to achieve the Sustainable Development Goals (SDG 2030) which is core 9, achieving stability and green technology in infrastructure, innovation and industry. Based on the data that has been found, this concrete is suitable as a non-structural construction material such as fences and buildings that do not have loads on it. In conclusion, this study has been completed and the findings of the study have been attached in chapter 4 and the objective has been achieved at the end of the study.

5.3 RECOMMENDATION

This study has been carried out taking into account various factors including the environment. It is hoped that this study on e-waste can continue to be carried out and implemented by the institution. This is aimed at producing students who are innovative and move along with the latest technological developments. In the next study, it is suggested to carry out an e-waste study in grade M10 concrete. In addition, it is suggested to carry out a study on concrete E-Waste by adopting the M15 concept and converting coarse rock to fine rock because the price of sand is increasing nowadays.

5.4 SUMMARY

In summary, this chapter has tell about the maximum rate of e-waste concrete that has been achieved which is 14.2 N/mm and the maximum load that can be accommodated is 323.9 Kn. In addition, this chapter has also shown that all three objectives have been achieved through the production of e-waste concrete. This chapter has also given some recommendations to be implemented apart from this study and why this study on e-waste needs to be conducted regularly.

REFERENCE:

REFERENCE:

- 1) Rolf Widmer, Heidi Oswald-Krapf, Deepali Sinha-Khetriwal, Max Schnellmann, Heinz Böni, Global perspectives on e-waste, *Environmental Impact Assessment Review*, Volume 25, Issue 5, 2005, Pages 436-458.
- 2) Gaidajis, G., Angelakoglou, K., & Aktsoylou, D. (2010). E-waste: environmental problems and current management. *Journal of Engineering Science and Technology Review*, 3(1), 193-199.
- 3) Alagusankareswari, K., Kumar, S. S., Vignesh, K. B., & Niyas, K. A. H. (2016). An experimental study on e-waste concrete. *Indian Journal of Science and Technology*, 9(2).
- 4) Masuduzzaman, M., Amit, S. K. S., & Alauddin, M. (2018, January). Utilization of E-waste in Concrete and its Environmental Impact-A Review. In *2018 international conference on smart city and emerging technology (ICSCET)* (pp. 1-4). IEEE.
- 5) Ahirwar, S., Malviya, P., Patidar, V., & Singh, V. K. (2016). An experimental study on concrete by using E-waste as partial replacement for coarse aggregate. *Int. J. Sci. Technol. Eng*, 3, 7-13.
- 6) Raut, S. R., Dhapudkar, R. S., & Mandaokar, M. G. (2018). Experimental study on utilization of E-waste in cement concrete. *The International Journal of Engineering and Science (IJES)*, 5(5), 82-86.
- 7) Hamsavathi, K., Prakash, K. S., & Kavimani, V. (2020). Green high strength concrete containing recycled Cathode Ray Tube Panel Plastics (E-waste) as coarse aggregate in concrete beams for structural applications. *Journal of Building Engineering*, 30, 101192.
- 8) Rathore, V., & Rawat, A. (2019, September). Effective utilization of electronic waste in concrete mixture as a partial replacement to coarse aggregates. In *AIP Conference Proceedings* (Vol. 2158, No. 1, p. 020037). AIP Publishing LLC.
- 9) Kumar, N., & Jaglan, A. (2022). A Review on Utilization of E-Waste in Construction. In *Proceedings of International Conference on Innovative Technologies for Clean and Sustainable Development (ICITCSD-2021)* (pp. 33-48). Springer, Cham.
- 10) Widmer, R., Oswald-Krapf, H., Sinha-Khetriwal, D., Schnellmann, M., & Böni, H. (2005). Global perspectives on e-waste. *Environmental impact assessment review*, 25(5), 436-458.

11) Gaidajis, G., Angelakoglou, K., & Aktsoglou, D. (2010). E-waste: environmental problems and current management. *Journal of Engineering Science and Technology Review*, 3(1), 193-199.

12) Suja, F., Abdul Rahman, R., Yusof, A., & Masdar, M. S. (2014). E-waste management scenarios in Malaysia. *Journal of Waste Management*, 2014.