

POLITEKNIK

SULTAN SALAHUDDIN ABDUL AZIZ SHAH

**AUTOMATIC SANITIZATION STATION WITH
COUNTER (PLUS MINUS)**

NAME

REGISTRATION NO

FERHAD ILMYZAT BIN

08DEP20F1039

FAIRUL HAMNI

JABATAN KEJURUTERAAN ELEKTRIK

SESI 2 : 2021/2022

**AUTOMATIC SANITIZATION STATION WITH
COUNTER (PLUS MINUS)**

NAME

FERHAD ILMYZAT BIN FAIRUL
HAMNI

REGISTRATION NO

08DEP20F1039

This report submitted to the Electrical Engineering Department in fulfillment of the requirement for a Diploma in Electrical Engineering

JABATAN KEJURUTERAAN ELEKTRIK

SESI 2 : 2021/2022

CONFIRMATION OF THE PROJECT

The project report titled "Automatic Sanitization Station with Counter (plus minus)" has been submitted, reviewed and verified as a fulfills the conditions and requirements of the Project Writing as stipulated

Checked by:

Supervisor's name : Pn Zarina Bte Md Amin

Supervisor's signature:

Date :

Verified by:

Project Coordinator name :

Signature of Coordinator :

Date :

“I acknowledge this work is my own work except the excerpts I have already explained to our source”

1. Signature :

Name : **FERHAD ILMYZAT BIN FAIRUL HAMNI**

Registration Number : **08DEP20F1039**

Date :

DECLARATION OF ORIGINALITY AND OWNERSHIP

TITLE : AUTOMATIC SANITIZATION STATION WITH COUNTER (PLUS MINUS)

SESSION: SESI 1 2021/2022

1. I, **1. FERHAD ILMYZAT BIN FAIRUL HAMNI / 08DEP20F1039**

is a final year student of Diploma in Electrical Engineering, Department of Electrical, Politeknik Sultan Salahuddin Abdul Aziz Shah, which is located at Persiaran Usahawan, 40150 Shah Alam, Selangor. (Hereinafter referred to as 'the Polytechnic').

- 2. I acknowledge that 'The Project above' and the intellectual property therein is the result of our original creation /creations without taking or impersonating any intellectual property from the other parties.
- 3. I agree to release the 'Project' intellectual property to 'The Polytechnics' to meet the requirements for awarding the Diploma in Electrical Engineering to me.

Made and in truth that is recognized by;

a) **FERHAD ILMYZAT BIN FAIRUL HAMNI**)
(Identification card No: - 020522-04-0439))
.....
) **FERHAD ILMYZAT BIN FAIRUL HAMNI**

In front of me, **Pn Zarina Bt Md Amin** (740505-01-5712))
) **Pn Zarina Bt Md Amin**
As a project supervisor, on the date:

ACKNOWLEDGEMENTS

I have taken efforts in this Project. However, it would not have been possible without the kind support and help of many individuals and organizations. I would like to extend my sincere thanks to all of them. I am highly indebted to (Name of your Organization Guide) for their guidance and constant supervision as well as for providing necessary information regarding the Project & also for their support in completing the Project.

I would like to express my gratitude towards my parents & member of (Organization Name) for their kind co-operation and encouragement which help me in completion of this Project. I would like to express my special gratitude and thanks to industry persons for giving me such attention and time.

My thanks and appreciations also go to my colleague in developing the Project and people who have willingly helped me out with their abilities.

ABSTRACT

In this project, an automatic sanitizing mist machine is non-contact, alcohol based sanitizer solution which finds it's use in hospitals, offices, workplaces, schools and any other premise. Alcohol is basically a solvent and also a very good disinfectant if we compare it to liquid soap. Also, it does not need water to wash off since it is volatile and vaporizes instantly. It is also proven that more than 70% of alcohol can kill Coronavirus in hands. Here , an ultra-sonic sensor is used to sense any motion near it while Arduino is used as microcontroller. As a result, a mist form of sanitizing solution is sprayed out. The counter on the other hand is bi-directional which means any motion that moves within 9cm from the other ultra-sonic sensor is detected, the LCD display number will increase by 1 while any motion more than 9cm will be counted as a person leaving. So, the number displayed on the LCD will be subtracted by 1. This will help workers and owner of the premise make sure that the place is not crowded and safe for any customer to enter the building

TABLE OF CONTENTS

CONFIRMATION OF THE PROJECT	i
DECLARATION OF ORIGINALITY AND OWNERSHIP	iii
ACKNOWLEDGEMENTS	iv
ABSTRACT	v
TABLE OF CONTENTS	vi
CHAPTER 1	1
1 INTRODUCTION	1
1.1 Introduction	1
1.2 Background Research	2
1.3 Problem Statement	3
1.4 Research Objectives	3
1.5 Scope of Research	3
1.6 Project Significance	4
1.7 Chapter Summary	4
CHAPTER 2	5
2 LITERATURE REVIEW	5
2.1 Introduction	5
2.2 Covid-19 problems in current years (Literature Review Topic 1)	6
2.2.1 Previous Research on how to stop Covid-19 from spreading	6
2.3 Chapter Summary	7
CHAPTER 3	8
3 RESEARCH METHODOLOGY	8
3.1 Introduction	8
3.2 Project Design and Overview.	8
3.2.1 Block Diagram of the Project	8
3.2.2 Flowchart of the Project 2	9
3.2.3 Project Description	9
3.3 Project Hardware	10
3.3.1 Schematic Circuit	10
3.3.2 Description of Main Component	11
3.3.2.1 Arduino UNO	11
3.3.2.2 Ultra-sonic sensor	11
3.3.2.3 Water pump	12
3.4 Project Software	12
3.4.1 Flowchart	14
3.4.2 Description of flowchart	15
CHAPTER 4	16
4 CONCLUSION AND RECOMMENDATION	16
4.1 Conclusion	16
4.2 Recommendation	16
REFERENCES	17

CHAPTER 1

1 INTRODUCTION

1.1 Introduction

Looking at the market today, efficiency in production is commonly known as the key of success in this tough competition. The rate at which products are produced is referred to as "production efficiency." Product quality is being improved while material and labour costs are being reduced is highly possible. There are fewer rejects, resulting in reduced downtime in production equipment, as well as low-cost manufacturing equipment. Taking this into consideration, the project is in its last stages of development, from which industries will benefit greatly.

Alcoholic sanitizer generally contains alcohol or isopropanol as the active ingredients that kill germs and bacteria. The contents of alcohol in the hand sanitizing product usually ranges between 60% to 90% which is considered by FDA to be effectively killing of germs and bacteria this include Covid-19 and E.coli

A contactless sanitizing station sprays liquid alcohol based sanitizer mist one a person passes the IR sensor for 3 seconds. 30 to 35 ml of sanitizer ensuring optimum usage and releases full sprays mist for estimatly 8 to 10 seconds in a single operation

Sanitizing liquid, also called as antiseptic is applied to the part of our body for the purpose of removing disease-causing organisms. Body hygiene is one of the most important measures to prevent the spread of infectious disease. Sanitizer is highly recommended when a person is about to enter a premise with people inside and maybe cause to make physical contact without knowing or when repeated hand washing compromises the natural skin barrier.

Although the effectiveness of sanitizing is variable, it is employed as a simple means of infection control in a wider areas such as shops, malls, markets and clinics. As a result of rising awareness about body hygiene and its benefits, there has been a constant increase in demand of sanitizers. In this project, sanitizers comes in mist form

Next up, it is very important to prevent a premise to become crowded to minimize physical contact from happening. The maximum capacity of a premise depends on the size as well. The bigger the premise, the higher maximum capacity of the premise. In this project, There is also a LED display mounted right next to the sanitization station to let visitors and workers see the amount of people inside the building easily.

1.2 Background Research

COVID-19 is mainly spread through the air in drops of liquid that come from the nose and mouth of an infected person. The drops are usually too small to see. They scatter when an infected person coughs, sneezes or talks. When the drops reach the eyes, nose or mouth of another person, the infection spreads. The more time you spend in close contact with an infected person, the greater the chance that drops containing the virus will reach your eyes, nose or mouth.

In crowded indoor places with poor ventilation, tiny drops containing the virus can sometimes spread over a longer distance. It's much safer to meet people outdoors than indoors, even if you keep more than 2 metres apart indoors. Avoid crowded or stuffy places as much as possible. Leave a location if it becomes crowded and stuffy. Ventilation can dilute and remove the drops, this helps reduce the spread of COVID-19.

When you meet people indoors, let some fresh air in by opening windows, doors or air vents as much as possible. You can also get the virus from infected surfaces. For example, when someone who has the virus sneezes or coughs, droplets with the virus can fall onto surfaces around them. If you touch that surface and then touch your eyes, nose or mouth, you could become infected too. Getting COVID-19 from surfaces is probably much less common than getting it through the air from someone who has the virus. But keeping your hands clean can reduce the risk of getting COVID-19 and other infections.

Commented [FAP1]: This section contains the introduction to the issues which the research/project is concerned

1.3 Problem Statement

According to a website called covidnow, Corona virus reached almost 30,000 cases once (mid 2021) and even though it is getting lower, it is still over 7000 cases daily. This proves how easy the corona virus is to spread. With at least 60% alcohol can help us avoid getting sick and spreading germs to others. In controlling the spread of the virus, soap breaks the bond of materials (germs or chemicals) that attach to the skin, which are washed away with water. Alcohol-based sanitizer is recommended by the CDC

Also, Lots of irresponsible customers entering the premise even the maximum capacity is exceeded. That is why a LED display is mounted at the side of the station. This may prevent the building from being crowded. Only *malls* and standalone stores with Gross Floor Area (GFA) of more than 7,000 sqm are *allowed* to have more than 1,000 *people*.

1.4 Research Objectives

The objective of putting this idea into action is to determine the issues locals in Malaysia are having with their current mailboxes. As soon as an issue is identified, efforts are made to come up with solutions that will help the society to settle their tasks without any worries.

More specifically the principle objective of this research are:

1. To design a counter to show the total number of people in a premise.
2. To develop a system automatically sanitize the customer.

1.5 Scope of Project

This Project is focusing on a system automatically sanitize the customer. It is installed in front of a building or premise entrance and exit

1.6 Project Significance

The automatic sanitization station with counter (plus minus) is invented to help shop owner and workers spend less time managing customers getting in and getting out from the building by showing the amount of customer inside the building on the LCD display. The customer walking past the IR sensor will send data to the Arduino UNO and from there, the LCD will get the information of people going in or out the building. Not only that, this project will also feature an automatic sanitizing mist to keep the customers and workers safe from any kind of infection. It is way better than putting a bottle of sanitizer on a table because this project will make sure there is no physical contact happen when customers are entering or leaving the building. My project goal is definitely to keep our society safe from any kind of disease, infection or illness during doing the things they love like shopping and settling mandatory tasks.

1.7 Chapter Summary

This chapter contains all of the procedures for this project. Including, problem statement, study objectives, and and study scope. This concept came to me through the internet, and it has now evolved into a human need, especially during current pandemic. There is also background research on our topic here.

Commented [FAP2]: This section contains the significance of the proposed project/research. You should cite previous research in this area. You should cite those who had the idea or ideas first, and should also cite those who have done the most recent and relevant work. You should then go on to explain why more work was necessary (your work, of course.)

CHAPTER 2

2 LITERATURE REVIEW

A research article is considered "literature" if it is used to comprehend and analyse the research subject. The literature review is used to provide the context of the study by looking at the research that has been conducted in the field of research and not just summarizing the research conducted by other researchers. This chapter's contents may include a succinct introduction to the study's subject, concept, or theory, as well as summaries of comparable earlier studies.

2.1 Introduction

When it comes to settling things, most of us will think of doing them with the help of automated machines because they will definitely save us time and energy. Yet, when we take a look at most of the stores or premises in this country, we always see a bottle of sanitizer, a pen and a book with a worker or security guarding the entrance as "safety method" to maximize the premise's safety from the spread of Covid-19 or any highly contagious diseases. But it is clearly does not actually maximize the premise safety as it doesn't prevent customers from direct contact from happening. Also by doing this conventional method, it will just waste the worker's energy guarding the entrance and give them less time to do their actual work. Thankfully we can stop it from happening again. In this project, we are going to use Arduino to control every part of this project. It will become the brain of our project. 2 IR sensor is used as well. One is to detect customers getting in and out of the building while showing the amount of customer currently in the building, while the other one activates the automatic sanitizing mist.

Commented [FAP3]: This section contains the introduction of this chapter. Briefly tell the reader what are the important matters will be reviewed during the project/research development.

2.2 Covid-19 problem in current years.

According to current evidence, the virus transmits primarily amongst people who are in close proximity to one another, such as at a conversational distance. When an infected person coughs, sneezes, speaks, sings, or breathes, the virus spreads in little liquid particles from their mouth or nose. When infectious particles in the air are breathed at close range (this is known as short-range aerosol or short-range airborne transmission) or when infectious particles come into direct contact with the eyes, nose, or mouth, another person can get the virus (droplet transmission). It is also advised for people to avoid crowded places.

2.2.1 Previous Research on how to stop Covid-19 from spreading

Hand sanitizer, also known as hand antiseptic or hand rub, is a substance that is applied to the hands to kill bacteria. Hand sanitizers come in a variety of forms, including foam, gel, and liquid. When there is a lack of water and soap, or if there are other medical issues, they are suggested for use. The simplest approach of reducing transmission is prophylaxis, whereas regular hand washing and hygiene are the most effective pandemic methods. In both healthcare and public institutions, hand sanitizers have become a viable alternative to soap and water cleansing. They are one of the most significant protocols for minimising the load on healthcare since they are used to break the cycle of infections. For those who are at a higher risk of infection, such as the elderly or those with weakened immune systems. To avoid crowds, Dr. Faiman recommends having a family member or friend assist them in getting the items they require from the store.

2.3 Chapter Summary

The purpose of this chapter's discussion is to define the sensor's perspective as it has been employed in previous research or projects, as well as to categorise how closely this project is linked to previous studies and theories. In addition, this chapter will demonstrate the principles and concepts used to solve the problem. When conducting any form of research, theoretical concerns are crucial.

We chose two ultrasonic sensors to detect any motion from the consumer passing by the counter as a result of this chapter. They can be employed in a wide variety of electronic products due to their low power consumption. Aside from that, they can detect motion with nearly the same accuracy in the presence or absence of light, and they don't require contact with the object to do so. Furthermore, this sensor is readily available on the internet and is inexpensive.

Commented [FAP4]: Each chapter must include the summary of the chapter as its final subsection. In this subsection, you must summarize the contents of the chapter in solid sentences.

CHAPTER 3

3 RESEARCH METHODOLOGY

3.1 Introduction

A method and approach for developing, collecting, and analysing data in order to provide evidence that can support a research is known as methodology. Methodology shows how the best method can be used to tackle a problem under investigation. By detailing the research process, the methodology seeks to assist you in better using the approach.

This methodology provides a more detailed explanation of the use of materials used to carry out the project. It also includes step-by-step instructions for the work and steps to complete the project. This methodology is important for project implementation or improvement of existing projects on the market.

3.2 Project Design and Overview

3.2.1

Block Diagram of the Project

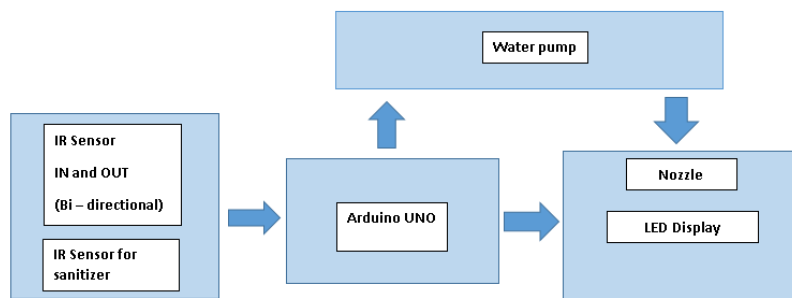

Commented [FAP5]: This section contains the introduction of this chapter. Briefly tell the reader what are the methods and techniques will be used in the project. This is important as it informs the readers on the methods used to achieve the objectives of the project that lead towards collecting the data and generate the findings reported

Commented [FAP6]: In this section, you can describe and explain the research methodology used in the study. The subsection may include the research design/research procedures adopted in terms of block diagram and flow chart. Note that all previous works must be cited according to APA (American Psychological Association) style.

3.2.2 Flowchart of the Project

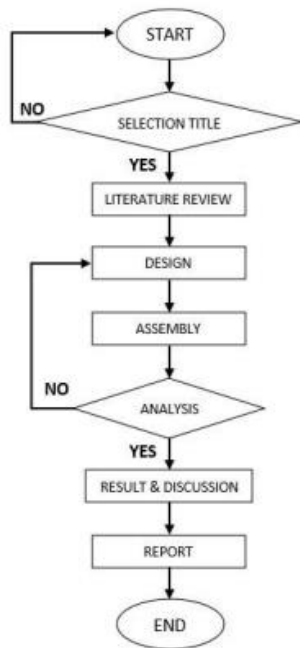

Figure 3.1: Flow chart of operation of the system
*Images may be subject to copyright

3.2.3 Project Description

The counter is always on during business hours on the premises, uses two ultrasonic sensors, which are a type of sensor. Detects each passing object, counts the number of people entering the store, and activates it Automatic disinfection mist. The LCD display shows the number of people in the building to avoid overcrowding while reducing the risk of Covid-19 spreading.

3.3 Project Hardware

Commented [FAP7]: Continue your chapter 3 with the discussion and explanation of your circuit diagram. Provide clear pictures of the circuit used in your project and explain your circuit operation.

3.3.1 Schematic Circuit

CIRCUIT VIEW

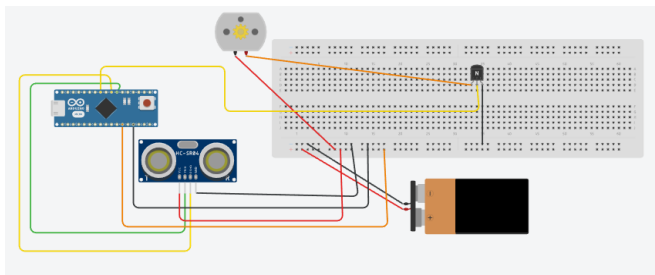
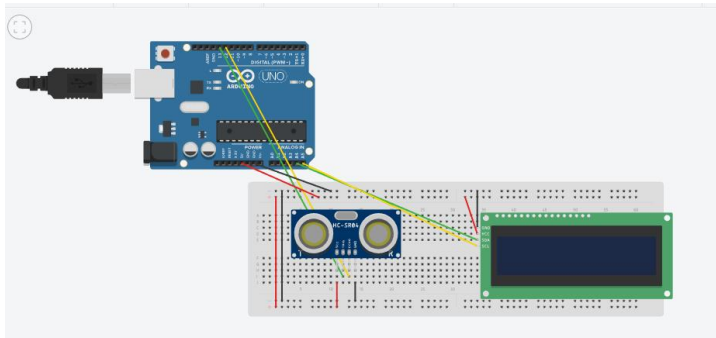

SCHEMATIC VIEW

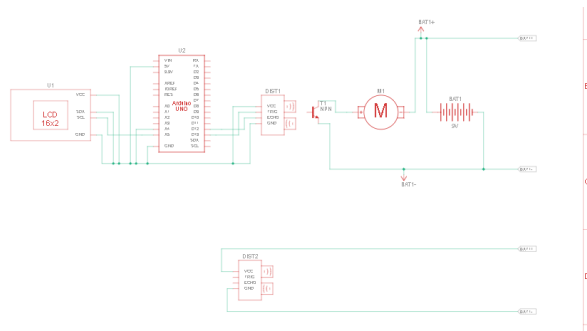

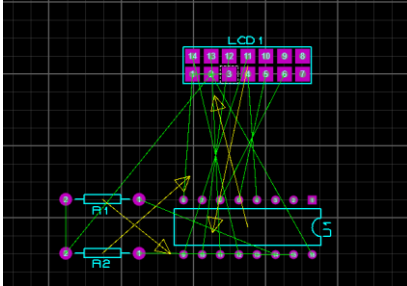

Figure 3.2 Software circuits

3.3.2 Description of Main Component

3.3.2.1 Arduino UNO



FIGURE 3.3

Arduino UNO is a microcontroller board based on the ATmega328P. It has 14 digital input/output pins (of which 6 can be used as PWM outputs), 6 analog inputs, a 16 MHz ceramic resonator, a USB connection, a power jack, an ICSP header and a reset button. It contains everything needed to support the microcontroller; simply connect it to a computer with a USB cable or power it with a AC-to-DC adapter or battery to get started. You can tinker with your UNO without worrying too much about doing something wrong, worst case scenario you can replace the chip for a few dollars and start over again.

3.3.2.2 Ultrasonic Sensor

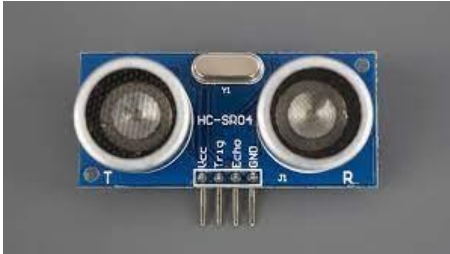

FIGURE 3.4

An ultrasonic sensor is an electronic device that measures the distance of a target object by emitting ultrasonic sound waves, and converts the reflected sound into an electrical signal. Ultrasonic waves travel faster than the speed of audible sound (i.e. the sound that humans can hear). Ultrasonic sensors have two main components: the transmitter (which emits the sound using piezoelectric crystals) and the receiver (which encounters the sound after it has travelled to and from the target).

3.3.2.3 Water Pump



FIGURE 3.5

A water pump is an electromechanical machine used to increase the pressure of water to move it from one point to another. Modern water pumps are used throughout the world to supply water for municipal, industrial, agricultural, and residential uses.

3.4 Project Software

Commented [FAP8]: Provide clear pictures of the circuit and software used to simulate the circuit connection.



FIGURE 3.6

Arduino IDE is a software that used to write and upload programs to Arduino compatible boards, but also, with the help of 3rd party cores, other vendor development boards. The Arduino Integrated Development Environment - or Arduino Software (IDE) - contains a text editor for writing code, a message area, a text console, a toolbar with buttons for common functions and a series of menus. It connects to the Arduino and Genuino hardware to upload programs and communicate with them.



FIGURE 3.7

Tinkercad is a free-of-charge, online 3D modeling program that runs in a web browser. Since it became available in 2011 it has become a popular platform for creating models for 3D printing as well as an entrylevel introduction to constructive solid geometry in schools.

3.4.1 Flowchart of the System

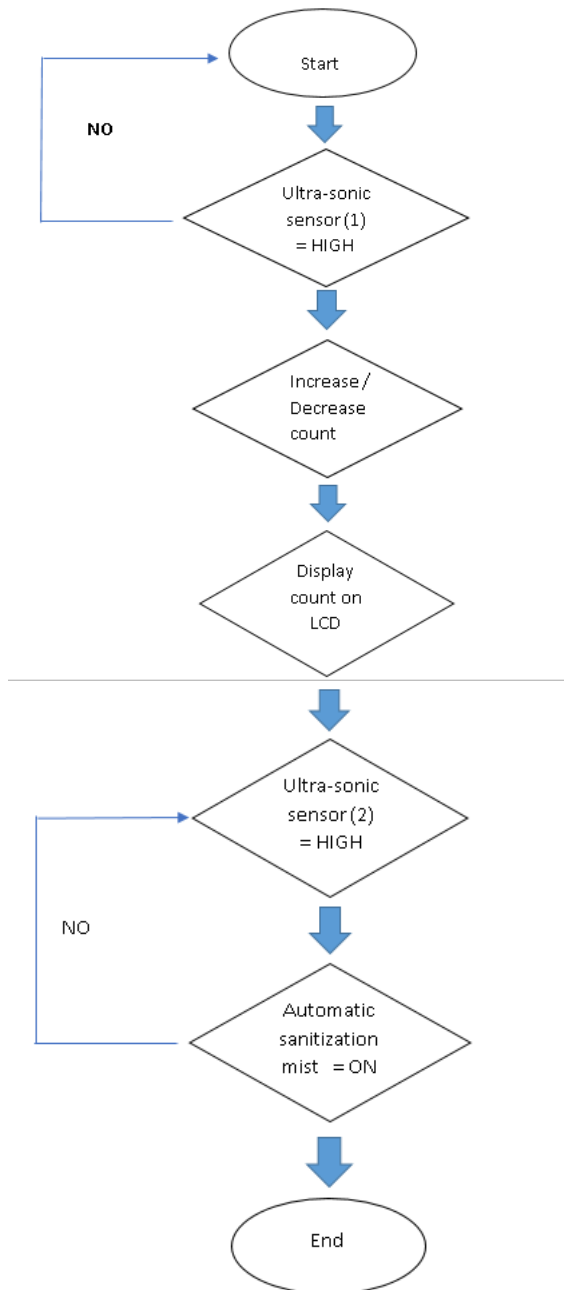

3.4.2 Description of Flowchart

Based on the figure above, the flowchart shows how the software is working step by step. The system will start if the ultra-sonic sensor detects a person that is passing by the sensor, if not it will be going back to the start and start it again. Next, if the Ultra sonic sensor detected a movement it will send the information to the microcontroller which is Arduino UNO to process the data that come from the sensor. The Arduino UNO will process the data based on the programming that I compile it to the microcontroller. After the data has being processed, the Arduino will sent the information LCD display to show the counter that has been detected by ultrasonic sensor. If the person passing by within 9cm as what we put in the programming, it will add 1 to the display while beyond 9cm will count as minus 1 meaning the person is getting out from the building. Next up, Another ultra-sonic sensor is installed to activate the automatic sanitization mist. If not, it will start again from the second sensor.

CHAPTER 4

4 CONCLUSION AND RECOMMENDATION

4.1 Conclusion

In this paper, I presented a writing approach for developing an Automatic sanitizing station with counter. The calibration of the system is done by successfully sanitizing and counting each people entering or and leaving the building. The number shown at the LED display will only shows the amount of people currently inside the building and now the total amount of people entered the premise.

4.2 Recommendation

When this project successfully entered the market, I believe that the demand will be good in the current market. Hence, I hope that this project will keep on continue expanding.

I hope that with this innovation can attract more interest and premise and shop owners who wants to create or improve the way of managing customers and keeping them safe. This innovation can not only going to save time than the conventional ways, but also putting our customers and worker's safety to the maximum level.

REFERENCES

1. American Journal of Infection Control ,Volume 35, Issue 10, Supplement 1, December 2007, Pages S27-S64
2. MMWR Morb Mortal Wkly Rep. 2020 Sep 11; 69(36): 1258–1264 Published online 2020 Sep 11.
3. IEEE Transactions on Industrial Electronics (Volume: 62, Issue: 2, Feb. 2015) , Page 910 – 921
4. Osong Public Health Res Perspect. 2020 Jun; 11(3): 93–100.
5. JUSIKOM, Vol 2 No.2, Desember 2017
6. Zeichen Journal , Volume 6, Issue 8, 2020 , Page No:233
7. Infection Control & Hospital Epidemiology , Volume 21 , Issue 1 , January 2000 , pp. 33 – 38
8. Chavez S, Long B, Koyfman A, Liang SY (2020) Coronavirus disease (COVID-19): a primer for emergency physicians. Am J Emerg Med

APPENDIX A (DATA SHEET)

APPENDIX B (PROGRAMMING)

For Bi-directional counter

```
#include <Wire.h>
#include <LiquidCrystal_I2C.h>
#define trigPin 13
#define echoPin 12
// Find LCD address for I2C in this tutorial it is 0x3f
LiquidCrystal_I2C lcd(0x3f, 16, 2);
int counter = 0;
int currentState1 = 0;
int previousState1 = 0;
int currentState2 = 0;
int previousState2 = 0;
int inside = 0;
int outside = 0;

void setup()
{
// initialize the LCD
lcd.begin();
//Serial.begin (9600);
pinMode(trigPin, OUTPUT);
pinMode(echoPin, INPUT);
}

void loop()
{
```

```
lcd.setCursor(0, 0);
lcd.print("IN: ");
lcd.setCursor(8, 0);
lcd.print("OUT: ");
lcd.setCursor(0, 1);
lcd.print("Total Inside: ");
long duration, distance;
digitalWrite(trigPin, LOW);
delayMicroseconds(2);
digitalWrite(trigPin, HIGH);
delayMicroseconds(10);
digitalWrite(trigPin, LOW);
duration = pulseIn(echoPin, HIGH);
distance = (duration/2) / 29.1;
if (distance <= 9){
currentState1 = 1;
}
else {
currentState1 = 0;
}
delay(100);
if(currentState1 != previousState1){
if(currentState1 == 1){
counter = counter + 1;}
lcd.setCursor(14, 1);
lcd.print(counter);
inside = inside +1;}
lcd.setCursor(4, 0);
lcd.print(inside);
if (distance > 9 && distance <= 18){
currentState2 = 1;
```

```
}  
else {  
currentState2 = 0;  
}  
delay(100);  
if(currentState2 != previousState2){  
if(currentState2 == 1){  
counter = counter - 1;}  
lcd.setCursor(14, 1);  
lcd.print(counter);  
outside = outside +1;}  
lcd.setCursor(13, 0);  
lcd.print(outside);  
lcd.setCursor(14, 1);  
lcd.print(counter);  
if (counter > 9 || counter < 0){  
lcd.setCursor(14, 1);  
lcd.print(counter);  
delay(100);  
lcd.clear();  
}  
}
```

For Automatic Sanitizer

```
#define echoPin 2
#define trigPin 3

long duration;
int distance;

void setup() {
  pinMode(trigPin, OUTPUT);
  pinMode(echoPin, INPUT);
  pinMode(5, OUTPUT);
  Serial.begin(9600);
}

void loop() {

  digitalWrite(trigPin, LOW);
  delayMicroseconds(2);
  digitalWrite(trigPin, HIGH);
  delayMicroseconds(10);
  digitalWrite(trigPin, LOW);
  duration = pulseIn(echoPin, HIGH);

  distance = duration * 0.034 / 2;
  Serial.print("Distance: ");
  Serial.print(distance);
  Serial.println(" cm");
  if (distance<=3)
  {
    digitalWrite(5, HIGH);
```

```
Serial.print("Pump On");  
delay(150);  
digitalWrite(5, LOW);  
Serial.print("Pump OFF");  
delay(2000);  
}  
else  
{  
  digitalWrite(5, LOW);  
  Serial.print("Pump OFF");  
  
}  
delay(50);  
}
```