



**MECHANICAL ENGINEERING DEPARTMENT
DIPLOMA OF MECHANICAL ENGINEERING
SESSION 2 2021/2022**

REPORT PROJECT

SMART GROCERY CART

PREPARED BY:

MUHAMMAD AFIQ SYAHMIE BIN SA'ADON

(08DKM20F1024)

MUHAMMAD NABIL AMSYAR BIN SUDIN

(08DKM20F1029)

ANIS ZULAIKHA BINTI AZLAN

(08DKM20F1036)

SUPERVISOR:

DR. NORASIAH BINTI MUHAMMAD

**POLITEKNIK SULTAN SALAHUDDIN ABDUL AZIZ
SHAH**

SMART GROCERY CART

MUHAMMAD AFIQ SYAHMIE BIN SA'ADON (08DKM20F1024)

MUHAMMAD NABIL AMSYAR BIN SUDIN (08DKM20F1029)

ANIS ZULAIKHA BINTI AZLAN (08DKM20F1036)

**This report is submitted to the Department of Mechanical Engineering
as fulfilling part of the conditions of the award Diploma in
Mechanical Engineering**

MECHANICAL ENGINEERING DEPARTMENT

SESSION I: 2022/2023

AKUAN KEASLIAN DAN HAK MILIK

SMART GROCERY CART

1. Kami, MUHAMMAD AFIQ SYAHMIE BIN SA'ADON (NO.KP; 020124-01-0613), MUHAMMAD NABIL AMSYAR BIN SUDIN (NO.KP; 020409-06-0227), ANIS ZULAIKHA BINTI AZLAN (NO.KP; 020217-05-0024) adalah pelajar Diploma Kejuruteraan Mekanikal, Politeknik Sultan Salahuddin Abdul Aziz Shah, yang beralamat di Persiaran Usahawan, Seksyen U1, 40150 Shah Alam, Selangor. (Selepas ini dirujuk sebagai 'Politeknik tersebut').
2. Kami mengakui bahawa 'Projek tersebut di atas' dan harta intelek yang ada di dalamnya adalah hasil karya/ reka cipta asli saya tanpa mengambil atau meniru mana-mana harta intelek daripada pihak-pihak lain.
3. Kami bersetuju melepaskan pemilikan harta intelek 'Projek tersebut' kepada 'Politeknik tersebut' bagi memenuhi keperluan untuk penganugerahan Diploma Kejuruteraan Mekanikal kepada kami.

Diperbuat dan dengan sebenar-benarnya diakui oleh;

MUHAMMAD AFIQ SYAHMIE BIN SA'ADON

(NO.KP; 020124010613)

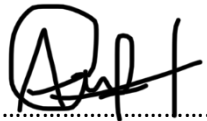

.....

MUHAMMAD NABIL AMSYAR BIN SUDIN

(NO.KP; 020409060227)



.....

ANIS ZULAIKHA BINTI AZLAN

(NO.KP; 020217050024)



.....

Di hadapan saya,

DR. NORASIAH BINTI MUHAMMAD

(NO. KP;770510036216)

Sebagai Penyelia projek pada tarikh 9/12/2022

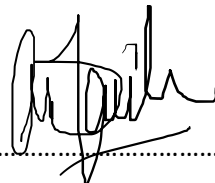

.....

APPRECIATION

Assalamualaikum , Bismillahirrahmanirrahim. Salutations and hello to all. First, we would like to express our gratitude to Allah SWT for allowing us to complete the project report on "SMART GROCERY CART" in the allocated period with the help of His abundant grace and permission.

Therefore, we would like to express our gratitude to our project managers, Dr. Norasiah Binti Muhammad, who have overseen our work from the beginning until the successful completion of this final project report.

Finally, the panel or academics participated in the production of this project also contributed a lot of advice or ideas that might further strengthen our project report, so we are grateful to our friends who offered us suggestions for improvement.

ABSTRACT

The project is applied from an observation based on consumers in supermarkets who must wait a long time to make a payment at the payment counter. The scope of this study focuses on developing and improvising current existing sell and purchase process that uses grocery cart to be quicker and more efficient for both seller and customers. Nowadays, consumers in every local supermarket are having problems where they must line up long and wait for a long time at the checkout counter. This can be clearly seen especially during the festive season, and it has become a heavy burden especially to the elderly who have health problems, those who are in a hurry and those who are carrying babies. This product has been designed and created specifically to facilitate consumers by reducing the time taken when shopping and during the payment process as well as speeding up the payment process while at the payment counter. The design of Smart Grocery Cart RFID Case was designed using Autodesk Fusion 360 Software and we produce it using 3D Printing. This project used Arduino system and RFID system for programming. In addition, the device system is divided into two, namely the consumer part, and the supermarket owner part. This product is also proven to solve the problems faced by users.

CHAPTER 1: INTRODUCTION

1.1 INTRODUCTION

In this world, most people use their equipment to simplify the affairs of their lives in all aspects. People always looking for something to help them do the heavy and hard work during their daily affairs. Because of that, trolleys were built to help reduce the use of manpower when lifting and moving heavy objects from one place to another. The history of the creation of the trolley first occurred in the United States at a time when people there were having difficulty in carrying the goods they spend. A man named Sylvan Nathan Goldman was the early creator of the trolley.

1.2 BACKGROUND RESEARCH

Over the past few decades, technology has been drastically changing the way of life in our societies. The current generation is becoming completely dependent on new technologies. Technology has affected society and its surroundings in several ways. In many countries, technology has helped developed more advanced facilities being used in daily life. It also allows more task to be completed in less time, increase efficiency, and create entirely new ways to make a living. Thus, it makes more areas of life to be improved.

Shopping mall is a place where most people in great hurry to get their daily necessities ranging from food product, apparels, toiletries, gardening tools, electrical appliances, and others. Consumers often face problems and inconvenience when shopping. They want a quick payment and enough budget. They worry that the amount of the money they bought is not enough to pay the items they had bought. Consumers sometimes got fed up with waiting and wasting unnecessary time at the counter. They also face insufficient information of the items for example the price of each item they want to purchase.

Smart Grocery Cart has been designed to make the consumers more satisfaction and comfortable when shopping. By using this trolley consumers can easily know the price of the items and at the same time the shoppers will also know the total price of the items thus will make the shoppers know the estimation of their expenditure.

A shopping trolley, also referred to as a shopping cart, shopping basket, or carriage, is a push able cart used by customers at a supermarket for carrying groceries to the check-out counter or to their vehicle. The shopping trolley is almost always provided by the store itself. A small handheld shopping basket is an alternative to using a shopping cart, particularly in smaller stores or when one only needs to pick up a few things.

In addition, this project will also be useful for the workers at the store to update the stocks of the items. The inventory system has been introduced to enable the storekeepers to detect the track sale of the stock that had been out for sale on that day.

1.3 PROBLEM STATEMENT

The main problem that are being confront by people is that they must queue long to make a payment at the checkout counter. This is because the number of people who went to grocery store and supermarket per day are extremely huge. From this, we can have witnessed in our country that grocery stores and supermarket in Malaysia are always being crowded by people per day. In addition, this number will increase during festive season. It can be a troublesome to a lot of consumers especially elderly who have health issue, those who are in a rush, and family who are carrying toddler. Other than that, people also must face crowded area during this pandemic season. As we all know, Covid-19 virus has now spread everywhere, and it is causing many deaths especially the elderly. It can spread easily through touch or even the air. So, because of this virus, people must avoid crowded places and we know that grocery stores and supermarkets always being crowded by people.

1.4 PROJECT OBJECTIVES

The objectives of this project are:

- i. To design a grocery cart with RFID system.
- ii. To create the RFID case using 3D Printing.
- iii. To install the RFID system to the trolley to solve long queue during payment sessions.

1.5 SCOPE OF THE PROJECT

- This project can carry a weight of 50kg to 80kg. This weight is enough to support the weight of the goods available in the market
- The size of the item to be purchased must be more than 1.5 inches. To buy the item should use plastic. To buy the item should use plastic.
- The height of the goods must not exceed 50cm.

1.6 THE IMPORTANCE OF THE PROJECT

- i. Can save time for consumers to shop.
- ii. Able to prevent the spread of disease outbreaks due to not having to queue for a long time.
- iii. Simplifies the payment process as there is no need to scan the code at the counter to pay.

1.7 DEFINITION OF OPERATIONAL TERMS

- **RFID:** Radio Frequency Identification (RFID) refers to a wireless system comprised of two components: tags and readers. The reader is a device that has one or more antennas that emit radio waves and receive signals back from the RFID tag. Tags, which use radio waves to communicate their identity and other information to nearby readers, can be passive or active [1].
- **INTERNET OF THING (IoT):** The Internet of things (IoT) describes physical objects with sensors, processing ability, software, and other technologies that connect and exchange data with other devices and systems over the Internet or other communications networks
- **INDUSTRIAL REVOLUTION 4.0 (I.R 4.0):** The Fourth Industrial Revolution, 4IR, or Industry 4.0, conceptualizes rapid change to technology, industries, and societal patterns and processes in the 21st century due to increasing interconnectivity and smart automation.

1.8 CHAPTER SUMMARY

In this chapter, the studies were discussed and explain about the introduction, research background, problem statement, objective of the project, scope of the project, definition of terms and summary in this study. In conclusion, these factors are very important in the success of a product. This study is important to get the details that need to be studied, updated, and considered for the success of this project.

CHAPTER 2: LITERATURE REVIEW

2.1 INTRODUCTION

At the initial stage of the project, a literature review was carried out a study previous which includes studies from sources such as internet sources, newspaper clippings, magazines and related resources smart grocery cart run. Collection of information from literature review is particularly important as an initial step of research. In implementation of aproject, various steps must be taken from the initial stage until the completion of a project. Problems encountered on the products studied and overhaul to get a better product.

2.2 SHOPPING CART ACROSS THE TIME

i. 1937 Foldable Basket Carriage

The shopping trolley is one of the most successful marketing inventions of the 20th century. It came into existence in 1937 as a by-product of a new kind of shopping experience popularised in the 1920s: the supermarket. The trolley was the idea of American supermarket owner Sylvan Goldman, who dreamed it up as a way of encouraging shoppers to buy more items in his Humpty Dumpty chain of stores. The frame was inspired by a folding chair and held two wire shopping baskets, one above the other, doubling the quantity of goods that could be carried. They were unpopular at first because they reminded women of prams and men considered them effeminate. To counteract this Goldman hired male and female models who spent their days pushing trolleys around his stores, leading to their gradual acceptance. Figure 2.1 below shows the 1937 Foldable Basket Carriage [2].



Figure 2.1 Foldable Basket Carriage

ii. 1946 Telescoping Shopping Cart

The next big innovation was made by Orla Watson in 1946. He came up with a design with a hinged rear panel which allowed trolleys to be easily pushed together for storage. The Telescope Cart was patented in 1949 and remains the model for most trolleys today. The 1950s saw massive growth of supermarket and mall-style shopping with huge parking areas, making a trolley an almost an obligatory shopping aid [3]. The density of customer traffic made compact storage essential. In 1954, the further refinement of a fold-down seat for toddlers meant that parents were free to focus on the shelves. Figure 2.2 below shows the Telescoping Cart made by Orla Watson.



Figure 2.2 1946 Telescoping Shopping Cart

iii. Driverless Shopping Cart

In 2012, a driverless shopping cart was made by Chaotic Moon Labs. The device, called "Project Sk8" or "Smarter Cart" was basically a cart fitted with Windows Kinect (to detect obstacles), and an electric drivetrain, and used in conjunction with a Windows8 tablet. For smaller stores, shopping baskets with wheels can be used either as a large basket or a small cart. These carts are designed for indoor use only [4]. Figure 2.3 below shows the Driverless Shopping Cart.



Figure 2.3 2012 Driverless Shopping Cart

2.2.1 THE DIFFERENCE BETWEEN AN OLD TROLLEY AND SMART GROCERY CART

In this modern age, many changes are taking place in terms of technology and many more. Table 2.1 below shows the difference between an old trolley and Smart Grocery Cart.

Table 2.1: The difference between an old trolley and smart grocery cart.

NO.	OLD TROLLEY	SMART GROCERY CART
1.	Use the payment process normally	Equipped with RFID system to make payment processing faster
2.	Takes a long time to make the payment	Saves time to make payments

2.3 RFID TECHNOLOGY DEFINITION

In recent years there have been urgent and increasing demands for smart cards by so many financial institutions as well as third-party payment companies, following the intelligent drift of bank cards from magnetic strips to chips. With full understanding of the present market and customers' demand, FMSH has developed many kinds of chip solutions as an appropriate reaction to meet the present need for chip cards [5].

End-to-end tracking of incoming and outgoing goods, confirming automatically that the intended materials and tools are being used in production, or providing access points with increased security. For such industrial tasks, RFID has proven itself as a powerful Auto-ID technology for Industry 4.0, with contactless transmission of large amounts of information, even over long distances, and easy connection to higher-level systems from PLC to ERP [6].

2.4 THE WORKING PRINCIPLE OF RFID TECHNOLOGY

RFID belongs to a group of technologies referred to as Automatic Identification and Data Capture (AIDC). AIDC methods automatically identify objects, collect data about them, and enter those data directly into computer systems with little or no human intervention. RFID methods utilize radio waves to accomplish this. At a simple level, RFID systems consist of three components: an RFID tag or smart label, an RFID reader, and an antenna. RFID tags contain an integrated circuit and an antenna, which are used to transmit data to the RFID reader (also called an interrogator). The reader then converts the radio waves to a more usable form of data. Information collected from the tags is then transferred through a communications interface to a host computer system, where the data can be stored in a database and analysed later [7].

Like barcode technology, RFID Scanner recognizes locations and identification of tagged items but instead of reading laser light reflections from printed barcode labels, it leverages low-power radio frequencies to collect and store data. In a warehouse or distribution centre, this technology is used to automate data collection. The transceiver reads radio frequencies and transmits them to an RFID tag. The identification information is then transmitted from a tiny computer chip embedded in the tag and broadcasted to the RFID reader.

2.5 ADVANTAGES & DISADVANTAGES OF RFID TECHNOLOGY

Radio Frequency Identification (RFID) is one of most exciting technologies,[6] but it also has some issue with it. Table 2.2 below shows the advantages and the disadvantages of RFID technology.

Table 2.2: Advantages & disadvantages of RFID technology

NO	ADVANTAGES	DISADVANTAGES
1.	Security	Lost Key Card
2.	Convenience	Hacker Alert
3.	Size	Power Shortage Issue
4.	Diverse	High Cost
5.	Master Card Functionality	Not Totally Hassle-Free

CHAPTER 3: METHODOLOGY

3.1 INTRODUCTION

Methodology is one of the chapters that describes about the activities which can be done to solve a problem. Selection of methodology to build a project is an important aspect of ensuring the project was built according to structured and systematic steps. Therefore, this chapter will explain about the steps taken to solve the problem of “Smart Grocery Cart”. For a clearer understanding of its implementation, the methodology will be shown in the form of a flow chart. This Smart Grocery Cart design is self -designed based on suggestions and discussions of group members. The flow chat of project research is presented in Figure 3.1

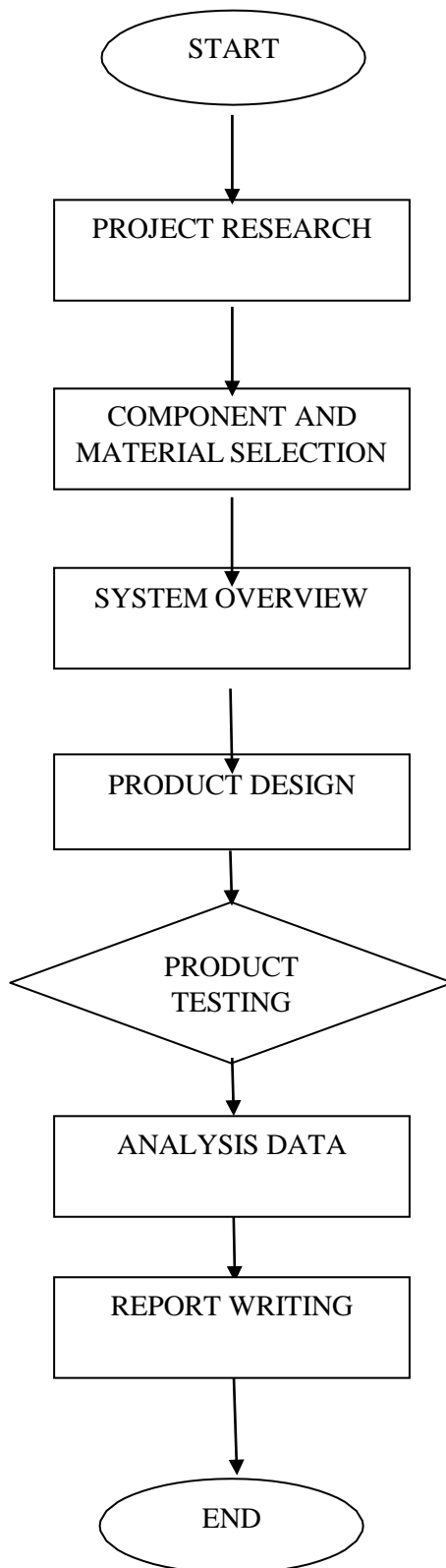

Figure 3.1 Flowchart of Methodology

3.2 FUNCTION OF THE PRODUCT

The general concept of this Smart Trolley System is designed in the form of its own payment system using RFID on the shopping trolley which enables customers to make payments for goods that are scan and placed before trolley. The smart trolley method is that the user takes the goods to be purchased and then scan using the RFID card. After the purchase, the user makes payment using an RFID card. This will make it easier for customersto make payments without waiting long while queuing. Our smart trolley design consists of the following components are RFID RC522, NodeMCU Microcontroller, RFID passive tags and LCD display. Therefore, customers do not have to wait long while queuing to make a payment and even make it easier for employees when the payment method.

3.3 RFID SYSTEM COMPONENTS AND MATERIAL SELECTION

The selection of the right components is very important in designing form Smart Grocery Cart to prevent any material abuse or components used. Among the components used are:

- i. RFID RC522 Module for Arduino
- ii. NodeMCU Microcontroller
- iii. Breadboard 800 Holes
- iv. Dupont Jumper Wires M/M
- v. RFID Passive Tags
- vi. Rechargeable Battery
- vii. Spring-coil
- viii. Polylactic Acid (PLA)
- ix. Ultrasonic
- x. Piezo Buzzer

3.3.1 RFID RC522 Module for Arduino

RFID stands for Radio-frequency identification and can be used for many applications that require an identification mechanism. The RC522 RFID Reader module as shown as Figure 3.3 is designed to create a 13.56MHz electromagnetic field that it uses to communicate with the RFID tags (ISO 14443A standard tags) [8]. The reader can communicate with a microcontroller over a 4-pin Serial Peripheral Interface (SPI) with a maximum data rate of 10Mbps.



Figure 3.2 RFID RC522 Module for Arduino

3.3.2 NodeMCU Microcontroller

The NodeMCU (Node Microcontroller Unit) is an open-source software and hardware development environment that is built around a very inexpensive System-on-a-Chip (SoC) called the ESP8266. The ESP8266, designed and manufactured by Expressive Systems, contains all crucial elements of the modern computer: CPU, RAM, networking (Wi-Fi), and even a modern operating system and SDK. However, as a chip, the ESP8266 is also hard to access and use. You must solder wires, with the appropriate analogue voltage, to its PINs for the simplest tasks such as powering it on or sending a keystroke to the "computer" on the chip. Figure 3.4 below shows the NodeMCU Microcontroller [9].



Figure 3.3 NodeMCU Microcontroller

3.3.3 Breadboard 800 Holes

In modern electronics and engineering circles, a breadboard refers to a (usually) solder-free, plug-and-play platform allowing for speedy insertion and removal of electrical components in circuit-building applications.

Breadboard kits today are a very popular toolbox product among electronics professionals, enthusiasts, and hobbyists alike. Interestingly, both meanings of the word ‘breadboard’ originally referred to the exact same object. Figure 3.5 below shows the breadboard 800 holes [10].

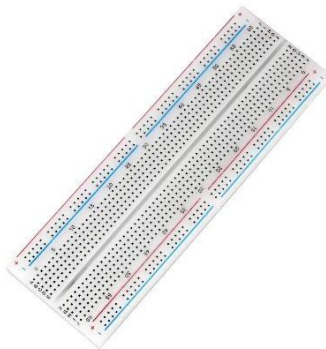

Figure 3.4 Breadboard 800 Holes

3.3.4 Dupont Jumper Wires M/M

A jump wire is an electrical wire, or group of them in a cable, with a connector or pin at each end, which is normally used to interconnect the components of a breadboard or other prototype or test circuit, internally or with other equipment or components, without soldering. Individual jump wires are fitted by inserting their "end connectors" into the slots provided in a breadboard, the header connector of a circuit board, or a piece of test equipment. There are different types of jumper wires. Some have the same type of electrical connector at both ends, while others have different connectors[11]. Some common connectors are solid tips, crocodile tips , banana connectors , registered jack , RCA connectors , RF connectors and RF jumper cables. Figure 3.6 below shows the Dupont Jumper Wires M/M.



Figure 3.5 Dupont Jumper Wires M/M

3.3.5 RFID Passive Tags

RFID tags are a type of tracking system that uses radio frequency to search, identify, track, and communicate with items and people. Essentially, RFID tags are smart labels that can store a range of information from serial numbers to a short description, and even pages of data. Some RFID tags include cryptographic security features for a high level of verification and authentication. RFID tags are usually identified by their radio frequencies: low frequency(LF), high frequency (HF), and ultra-high frequency (UHF) [12]. Figure 3.7 below shows the RFID passive tags.



Figure 3.6 RFID Passive Tags

3.3.6 Rechargeable Battery

A rechargeable battery, is a type of electrical battery which can be charged, discharged into a load, and recharged many times, as opposed to a disposable or primary battery, which is supplied fully charged and discarded after use. It is composed of one or more electrochemical cells. Rechargeable batteries are produced in many different shapes and sizes, ranging from button cells to megawatt systems connected to stabilize an electrical distribution network. Some rechargeable battery types are available in the same sizes and voltages as disposable types and can be used interchangeably with them [13]. Figure 3.8 below shows the rechargeable battery



Figure 3.7 Rechargeable Battery

3.3.7 Screw

A screw is a mechanism that converts rotational motion to linear motion, and a torque (rotational force) to a linear force. It is one of the six classical simple machines. The most common form consists of a cylindrical shaft with helical grooves or ridges called threads around the outside. The screw passes through a hole in another object or medium, with threads on the inside of the hole that mesh with the screw's threads. When the shaft of the screw is rotated relative to the stationary threads, the screw moves along its axis relative to the medium surrounding it. Geometrically, a screw can be viewed as a narrow-inclined plane wrapped around a cylinder. Like the other simple machines, a screw can amplify force, a small rotational force (torque) on the shaft can exert a large axial force on a load. The smaller the pitch (the distance between the screw's threads), the greater the mechanical advantage (the ratio of output to input force). Screws are widely used in threaded fasteners to hold objects together, and in devices such as screw tops for containers, vises, screw jacks and screw presses. Figure 3.9 below shows the collection of screws.



Figure 3.8 Collection of screws

3.3.8 Polylactic Acid (PLA)

PLA is a type of polyester made from fermented plant starch from corn, cassava, maize, sugarcane, or sugar beet pulp. The sugar in these renewable materials is fermented and turned into lactic acid, when is then made into polylactic acid, or PLA.

The material properties of PLA make it suitable for the manufacture of plastic film, bottles, and biodegradable medical devices, including screws, pins, plates, and rods that are designed to biodegrade within 6 to 12 months [15].

PLA can be used as a shrink-wrap material since it constricts under heat. This ease of melting also makes polylactic acid suitable for 3D printing applications. However, many types of PLA have a low glass transition temperature, making them unsuitable for making plastic cups designed to hold hot liquids. Figure 3.11 below shows the Polylactid Acid (PLA).



Figure 3.9 Polylactic Acid (PLA)

3.3.9 Ultrasonic

Ultrasonic Sensor HC-SR04 is a sensor that can measure distance. It emits an ultrasound at 40 000 Hz (40kHz) which travels through the air and if there is an object or obstacle on its path It will bounce back to the module. Considering the travel time and the speed of the sound you can calculate the distance [16]. Figure 3.12 below shows the ultrasonic.



Figure 3.10 Ultrasonic

3.3.10 Piezo Buzzer

An Arduino buzzer is also called a piezo buzzer. It is basically a tiny speaker that you can connect directly to an Arduino. You can make it sound a tone at a frequency you set. The buzzer produces sound based on reverse of the piezoelectric effect. The buzzer produces the same noisy sound irrespective of the voltage variation applied to it. It consists of piezo crystals between two conductors. When a potential is applied across these crystals, they push on one conductor and pull on the other [17]. This, push and pull action, results in a sound wave. Most buzzers produce sound in the range of 2 to 4 kHz.



Figure 3.11 Piezo Buzzer

3.4 SYSTEM OVERVIEW

In this section, the working operation of the RFID System will be explained in more detail. A description of how each component of the system such as the RC522 RFID Module and the NodeMCU Microcontroller interface with each other will also be described as well as the function of each component on the working operation of the RFID System. As well as system programming development work will be shown in this section where it consists of the use of Arduino IDE Software, Laragon Software and NodeJs software.

3.4.1 Basic Operation of the RFID System

The basic operation of the main work of this system consists of three main parts namely the purchase database management system software, microcontroller and RFID Reader Module, interface with each other.

A microcontroller (MCU for a microcontroller unit) is a small computer on a single metal-oxide-semiconductor (MOS) VLSI integrated circuit (IC) chip. The microcontroller contains one or more CPUs (processor cores) along with memory and programmable input/output devices. Program memory in the form of ferroelectric RAM, NOR flash or OTP ROM is also often included on the chip, as well as a small amount of RAM. Microcontrollers are designed for embedded applications, in contrast to microprocessors used in personal computers or other general-purpose applications that consist of a variety of discrete chips. This microcontroller function in this project is to send data to the database.

RFID (radio frequency identification) is a form of wireless communication that incorporates the use of electromagnetic or electrostatic couplings in the radio frequency portion of the electromagnetic spectrum to uniquely identify objects, animals, or people. This RFID reader serves to send data to the microcontroller

Organizations use large amounts of data. A database management system (DBMS) is a software tool that makes it possible to organize data in a database. The standard acronym for a database management system is DBMS, so you will often see this instead of the full name. The main purpose of a database management system is to store and convert data into information to support decision making.

To make things short, to make the whole system work it requires all three components to interface with each other by:

1. RFID readers receive data from RFID cards. Next, after receiving the data the RFID Reader will send the received data to the NodeMCU Microcontroller.
2. After obtaining the desired data the microcontroller will act as a data sender to the database to collect data.
3. The information software that has been delivered by the microcontroller will be collected in this section. A Database Management Software or DBMS is used for storing, manipulating, and managing data in a database environment.

Figure 3.12 below shows the block diagram of RFID system.

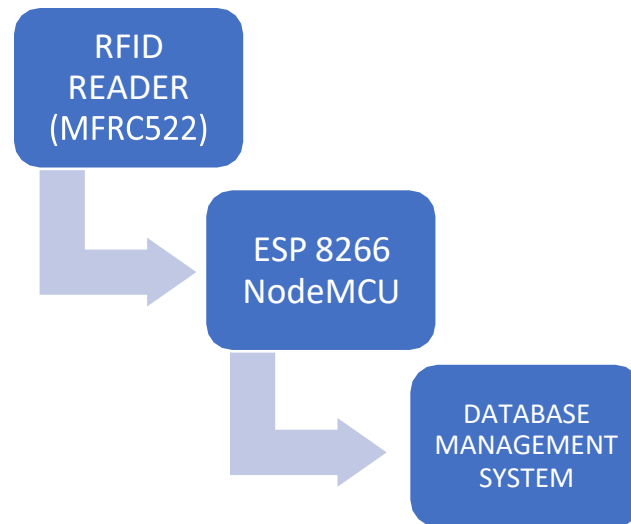

Figure 3.12 Block Diagram for The RFID System

3.4.2 Detailed Working Principle for RFID System Device for Grocery Cart.

This section will focus primarily on the way this product systems operation. For this product, the system will be implemented into two sections which are the customer section (system at grocery cart) and the retailer section (system at the cashier counter). Figure 3.13 below shows the flow chart of RFID System Device for Grocery Cart interface process at customer section and Figure 3.14 below shows the flow chart of RFID System Device for Grocery Cart interface process at retailer section.

A. Customer Section

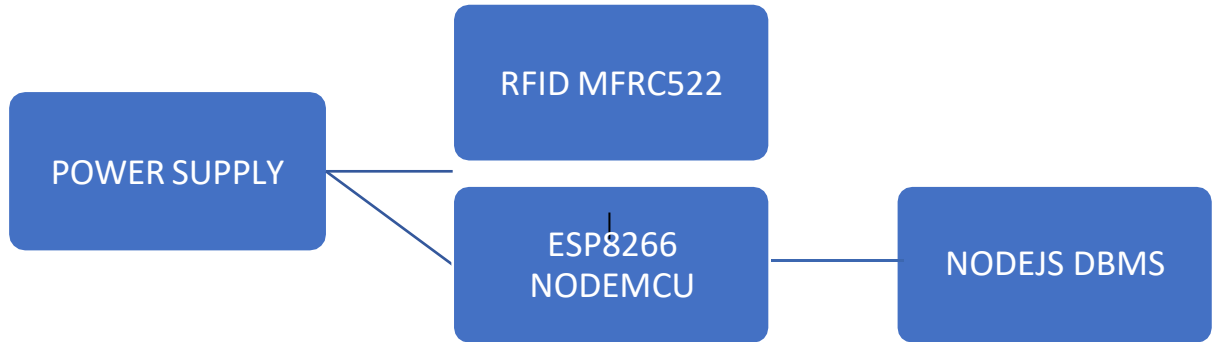

Figure 3.13 Flow chart of RFID System Device for Grocery Cart interface process at customer section

B. Retailer Section:

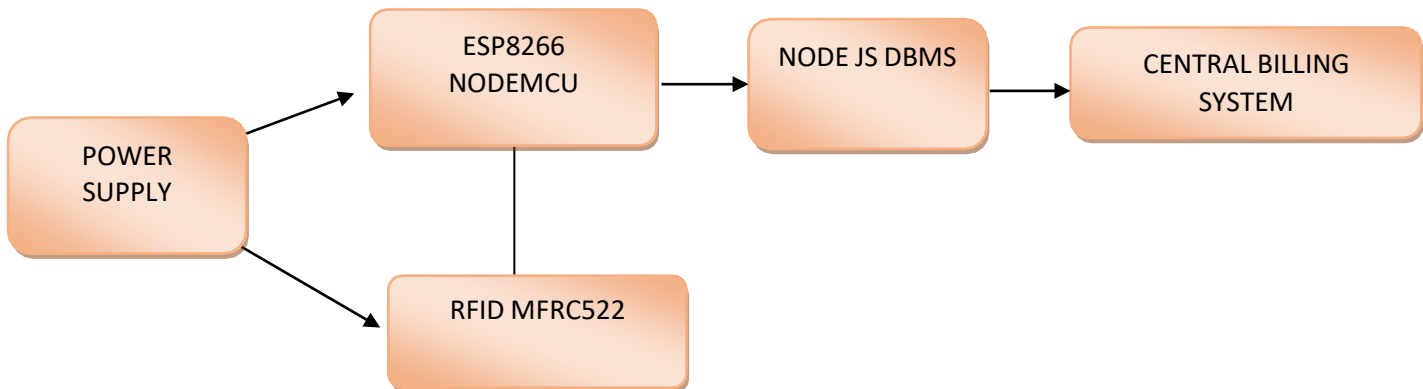

Figure 3.14 Flow chart of RFID System Device for Grocery Cart interface process at retailer section.

3.4.3 Operational Procedure of RFID System Device for Grocery Cart.

This section will explain about operational procedure of RFID System Device for Smart Grocery Cart. This section is divided into two section which is customer section and retailer section. It will explain from the customer enter the supermarket until at checkout session. Figure 3.15 below shows the Flowchart Operational Procedure of RFID System Device for customer section and Figure 3.16 below shows the Flowchart Operational Procedure of RFID System Device for Retailer Section.

A. Customer section:

1. Customers enter the premises.
2. After entering the premises, customers need to pick up the trolley and rfid tag at the place provided.
3. Customer scans the RFID tag on the RFID scanner on the retail cart.
4. When moving around the premises during shopping activities, customers can scan the items they want to buy. (NodeMcu Microcontroller translates information and sends this information to Node.js Database Management System Software).
5. Data of customers who purchase goods will be collected in the purchased goods database and sorted and can also be aggregated by total price.
6. After the shopping activity, customers will head to the payment counter directly.

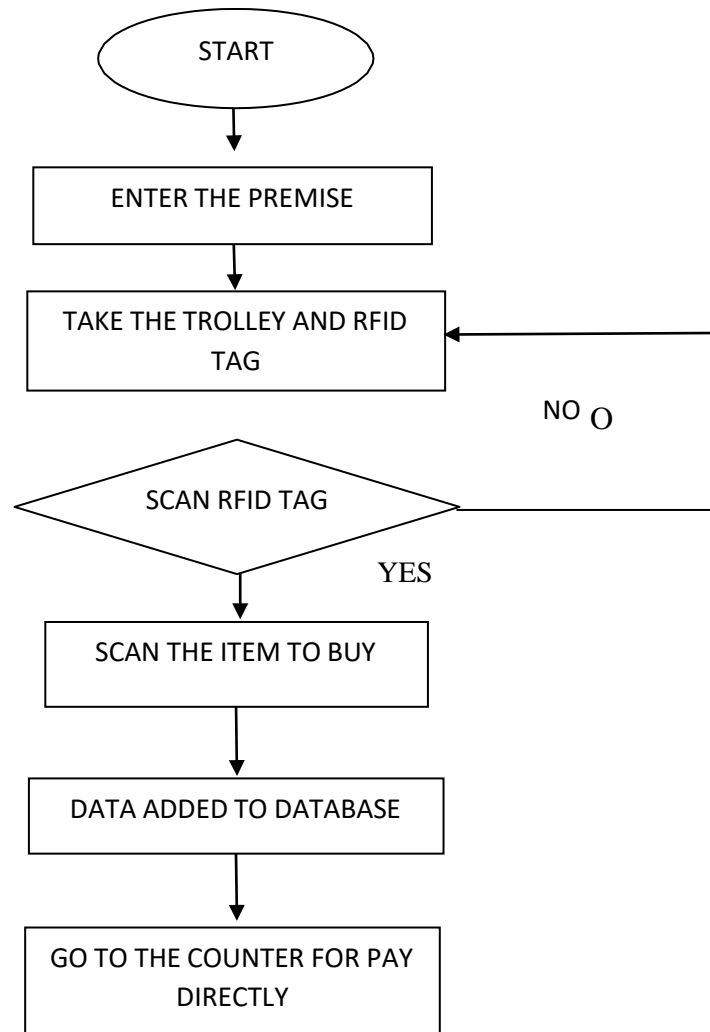

Figure 3.15 Flowchart Operational Procedure of RFID System Device for customer section

B. Retailer section:

1. Once the customer arrives at the counter, they need to submit the RFID tag to the cashier.
2. The cashier will scan the RFID tag through the RFID reader located at the counter.
3. This will make the system send data of items purchased by customers to the item base
4. The total price of the item purchased by the customer will appear on the counter screen.
5. The customer must pay the total amount of the item purchased through cash or online service.

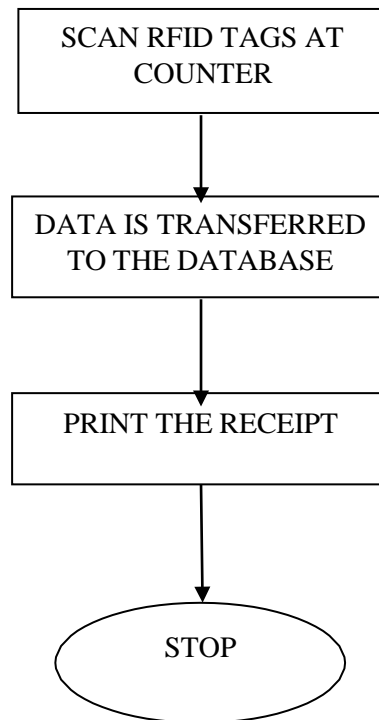

Figure 3.16 Flowchart Operational Procedure of RFID System Device for Retailer Section

3.5 PRODUCT DESIGN

This section is dedicated to project design. A 3D, Isometric, Orthographic Projection, Part Assembly and Exploded drawing has been drawn fully by using Autodesk Fusion 360 Software. This step is very crucial, as it determine the specification of our RFID Device and determine how the finishing of our project would look like.

3.5.1 Smart Grocery Cart 3D Design

The drawing that has been constructed is a drawing of Smart Grocery Cart as presented as Figure 3.17 below.



Figure 3.17 Smart Grocery Cart 3D Design

3.5.2 Exploded Drawing

The Smart Grocery Cart was contained in 15 parts which is;

- | | |
|-----------------|----|
| 1. Trolley | x1 |
| 2. Trolley leg | x2 |
| 3. Wheel holder | x4 |
| 4. Wheel | x4 |
| 5. RFID Case | x1 |
| 6. Hook | x1 |

Figure 3.18 and figure 3.19 below shows exploded drawing for Smart Grocery Cart and part list for Smart Grocery Cart

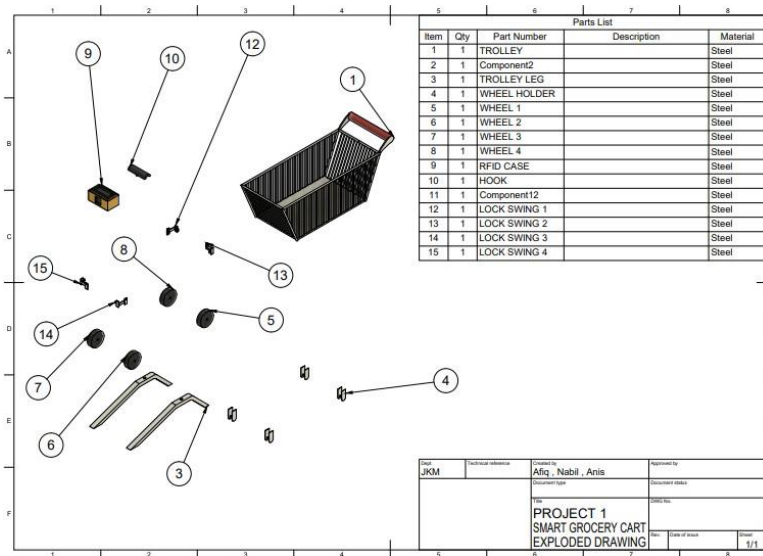

Figure 3.18 Exploded Drawing

Parts List			
Item	Qty	Part Number	Description
1	1	TROLLEY	
2	1	Component2	
3	1	TROLLEY LEG	
4	1	WHEEL HOLDER	
5	1	WHEEL 1	
6	1	WHEEL 2	
7	1	WHEEL 3	
8	1	WHEEL 4	
9	1	RFID CASE	
10	1	HOOK	

Figure 3.19 Part List of Design

3.5.3 Isometric Drawing

Isometric drawing is a method for visually representing 3D objects in two dimensions in technical and engineering drawing. Figure 3.20 below shows the isometric with orthographic drawing of Smart Grocery Cart from the front view, top view and right side view with its part list



Figure 3.20 Isometric Drawing

3.5.4 Trolley Drawing

This part of Smart Grocery Cart will act as the main part which is this trolley part will be used to store items that have been scanned using RFID scanner by the consumers. This part has 250mm long and 150mm width. Figure 3.21 below showed the orthographic trolley drawing with its dimensions.

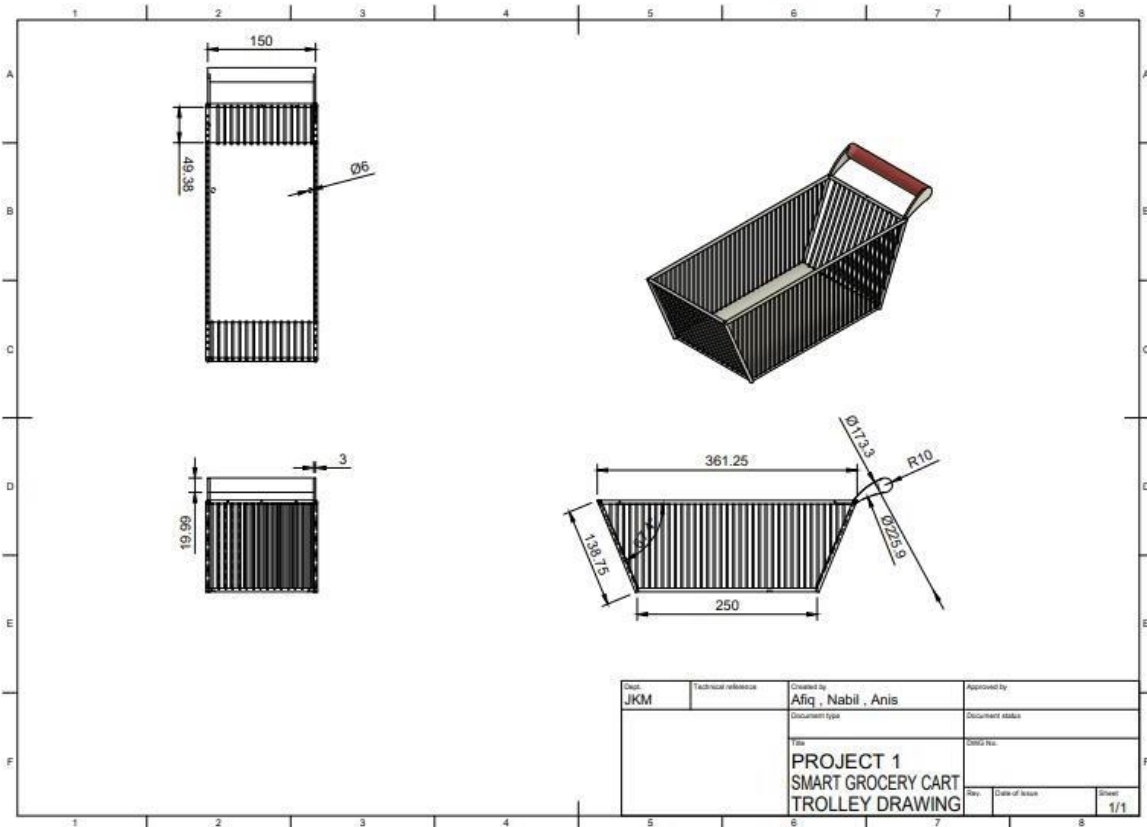

Figure 3.21 Trolley Drawing

3.5.5 Trolley Leg Drawing

This part will act as the leg of the trolley at the bottom part. There was 6mm hole for each side of this leg of the trolley. Next, the long of this trolley leg is 288mm and 15mm width. Figure 3.22 below shows the orthographic trolley leg drawing of Smart Grocery Cart.

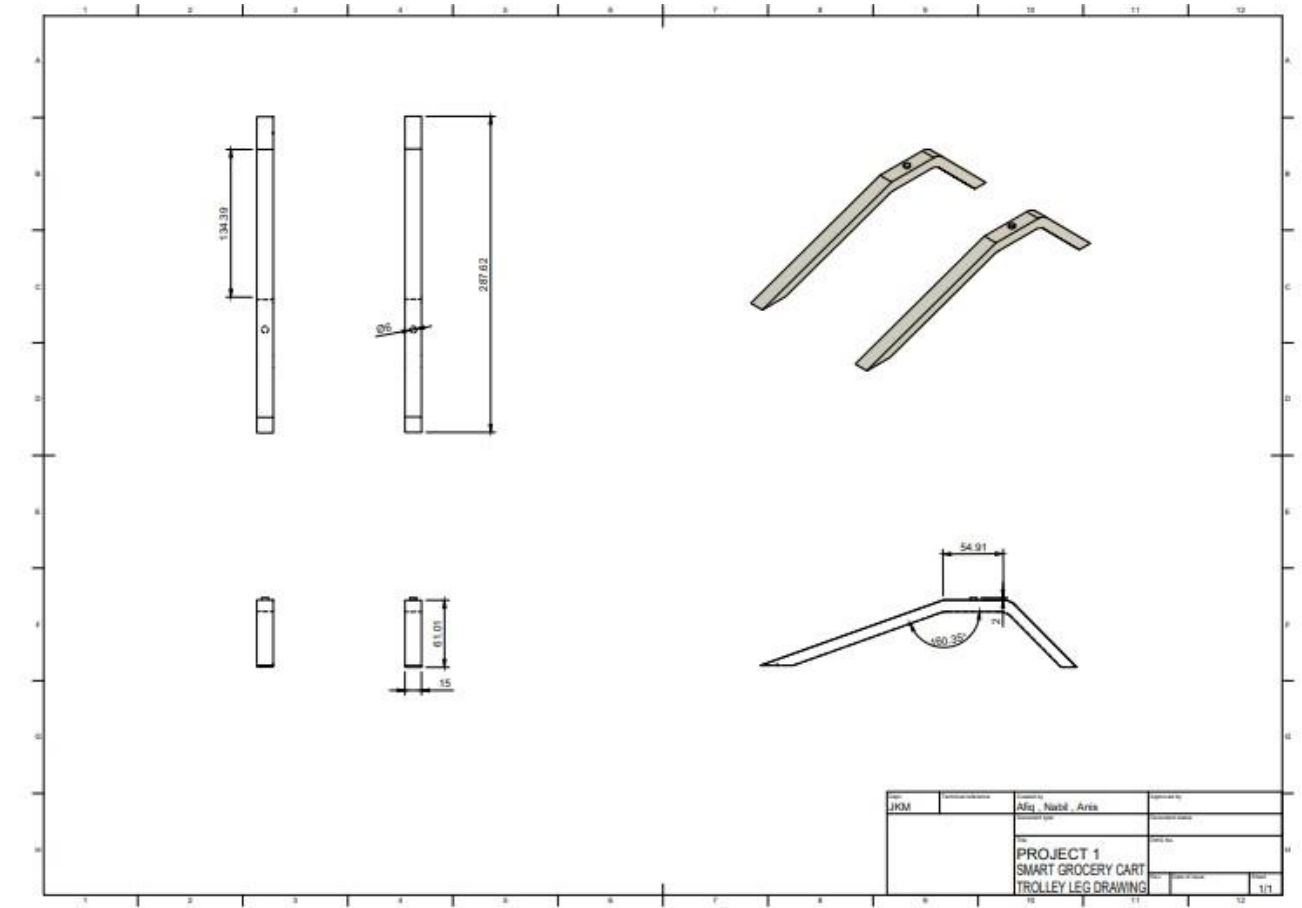

Figure 3.22 Trolley Leg Drawing

3.5.6 Wheel Drawing

This part will be functioned as a wheel for this trolley. This part is located at the bottom of the trolley leg. It comes also with the wheel holder. This wheel can make consumers easy to move around in the supermarket. The diameter of this wheel is 48mm and its also has a small hole at each side with diameter of 5mm to connect with its wheel holder. Figure 3.23 below shows the orthographic wheel drawing with its dimensions.

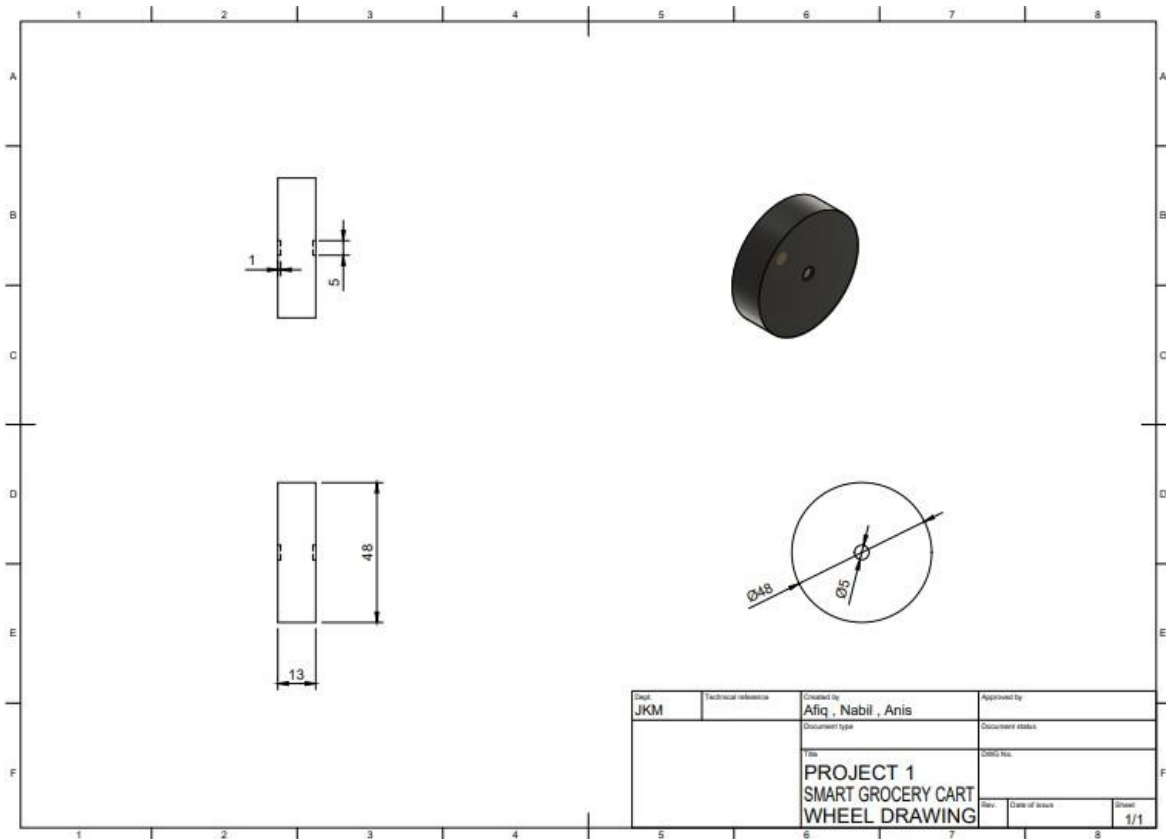

Figure 3.23 Wheel Trolley Drawing

3.5.7 RFID Case Drawing

This part is where all the device electrical circuit and components will be store inside of it. This RFID case has 70mm long, 40mm width and 40mm height. It also has a 2mm radius hole at the back of this case where hook will be attached to it. Figure 3.24 below shows the orthographic RFID case drawing.

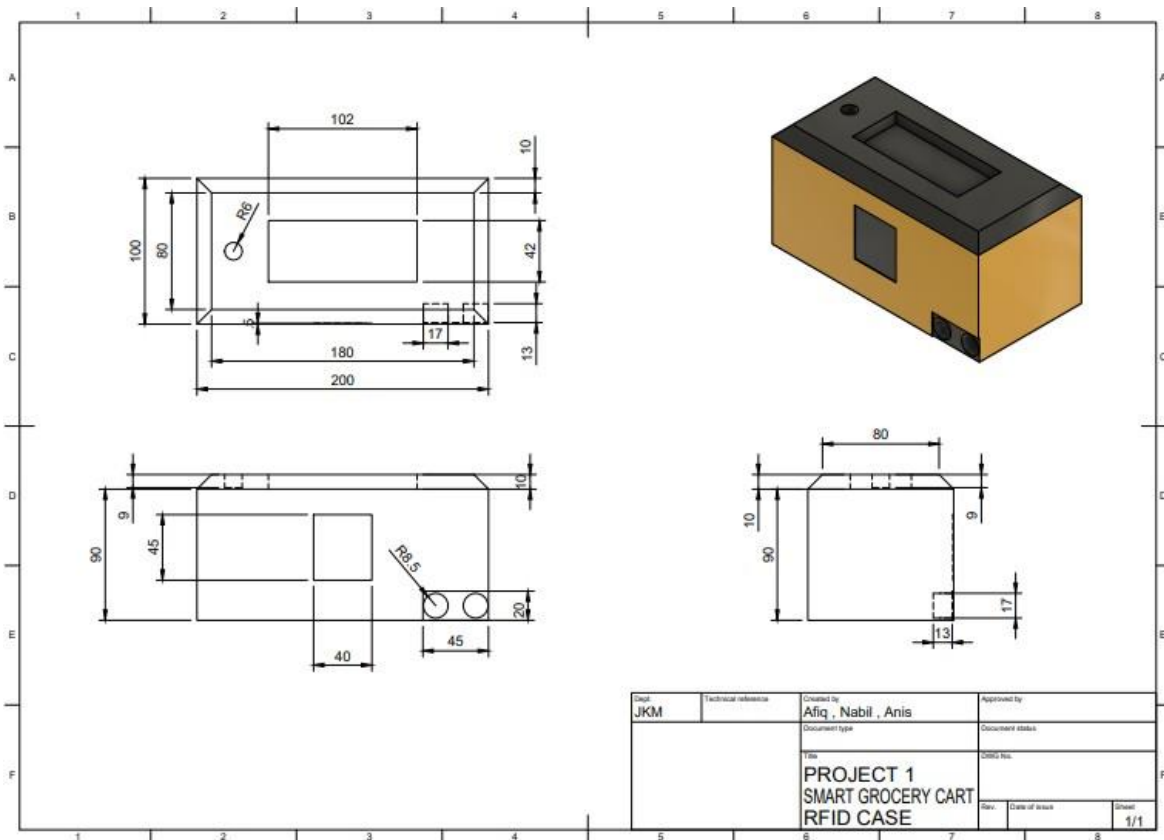

Figure 3.24 RFID Case Drawing

3.5.8 Hook Drawing

This part will be functioned as hook for the RFID Case for this Smart Grocery Cart. This hook has a 60mm long and 22mm width. This part will be hooked at the trolley to make consumers easy to scan their items. Figure 3.25 below shows the orthographic hook drawing of this Smart Grocery Cart.

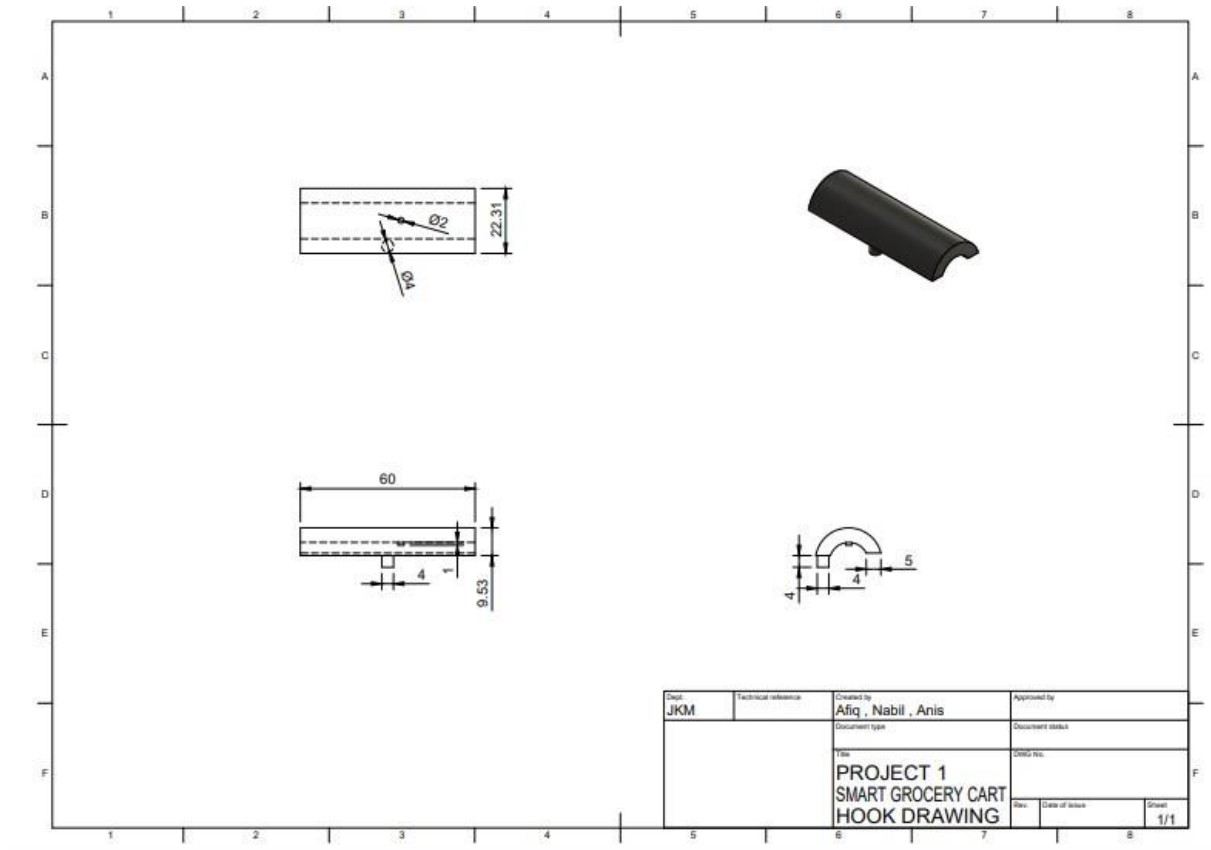

Figure 3.25 Hook Drawing

3.6 3D PRINTING

We ultimately come to an agreement on the use of 3D printing after much debate over how to fabricate the RFID Device Casing component. The talk is extensive since there are many options and methods, we can employ to create the case, including such as plastic resin casting, plastic extrusion, and plastic inject moulding, among many more. But further analysis reveals that in terms of costs, only 3D printing makes sense for us, which is more readily available, less expensive than alternative methods, and where to find 3D printing. In Malaysia, services are widely available and rapidly expanding. Table below demonstrated differences in the options we have for creating the enclosure.

Table 3.2 Differences in the options we have for creating the casing.

Types Characteristics	Plastic Inject Moulding	Plastic Resin Casting	3D Printing	Plastic Extrusion
Availability	Low	Low	High	Low
Cost	Expensive	Cheap	Cheap	Expensive
Complexity	High	High	Low	High
Quality	High	Low	High	High

Hence, we found a self-own 3D Printing service named “Fadhilah 3D CAD Designing and Printing” through our friend’s service nearby. It was run by a guy called Mr Muhammad Fadhilah Bin Abd Kadir. Figure below showed a picture with Mr Muhammad Fadhilah.



Figure 3.26 A picture with Muhammad Fadhilah

“Fadhilah 3D CAD Designing and Printing Service” details:

NAME OF CONSULTANT	MUHAMMAD FADHILAH BIN ABD KADIR
PHONE NUMBER	017-5090655
ADDRESS	Anjung Ilmu, Jabatan Mekanikal, Politeknik Shah Alam
EMAIL	printyourdream0001@gmail.com

3.6.1 What is 3D Printing?

3D Printing is one of the Rapid Prototyping technologies. It can print three-dimensional objects based on CAD models or digital 3D models under the control of a 3D printer. It is the process of printing an object by adding materials layer by layer, which is called Additive Manufacturing. Assume that 3D Printing is like printing files from a printer but using different technologies. For printing a piece of paper, you need a Word, PDF, or Excel document, which are all 2D. While printing an object, you will need 3D model designs in STL file format and 3D printable materials. When 3D models, STL files (need to convert into G-code through a slicer software), and 3D Printing materials are ready, 3D printer is being able to print the design layer by layer.

Distinguished from traditional manufacturing process, 3D Printing is a process of adding materials to create a product instead of machining on a block of material. The additive nature makes 3D Printing a unique manufacturing method, which is typically fast with relative low setup costs. 3D Printing can create more complex geometries than traditional manufacturing techniques, which has been utilizing in the engineering industry widely, particularly for prototyping and creating complex/ lightweight geometries.

3D Printing is connecting with engineers, designers, hobbyists, and amateurs, gaining popularity in the make culture. Available low-cost printing material, accessible printing techniques like FDM, and affordable desktop 3D printers (such as MakerBot, Ultimaker, and Form labs), are largely facilitate 3D Printing technology to grow fast.

3.6.2 Machine Used

The "Creality Ender 3 V2" 3D printer was used to fabricate the RFID device housing. Even though this model is not as wasteful as others like the Prusa i3 MK3, Makerbot Replicator Plus, and Ultimaker S3, created computer that is efficient and filled with beneficial features is more than enough to complete the task. This product was produced by a business in Shenzhen, China. The Creality Ender-3 V2 features a brand new 32-bit mainboard with extra-silent stepper motors that provide a noiseless printing experience, allowing for late-night printing sessions that won't interfere with one's sleep. Additionally, the printer offers a toolbox built inside its body, providing quick access to the most needed tools during printing. The Ender-3 V2 is a highly upgradable 3D printer that can be modified with a laser engraving head, BLTouch probe for automatic levelling, full enclosure, and much more. Creality Ender 3 V2 is depicted in the figure below.

3D Printer Model Details;



Figure 3.27 Creality Ender 3 V2 3D Printing

Model: Creality Ender 3 V2

Brand: Creality

Type: Filament Deposition

3.6.3 3D Printing Workflow Stages

1. Modelling in CAD software

- Drawing or producing a 3D model using software are both examples of modelling. You can create a 3D model from scratch in software, scan an actual thing with a 3D scanner, or use one that someone else has already created (Thingiverse is a good place to start). Your 3D printer will construct the model you design, scan, make, or acquire, provided it can handle the model's technical requirements.

2. Generating an STL or 3MF file

- In a raw, unstructured file called an STL, your three-dimensional object's surface geometry is all that is present. At the conclusion of the modelling process, CAD software generates it to define the surface and contour of the 3D model. A 3MF file accomplishes the same task but has extra information. An XML-based data format called 3MF contains information about textures, materials, colours, and mesh. Although 3MF is preferable to STL, you might only want an STL for simple models. We must create an STL or 3MF file since those files are required to build the G-code that your 3D printer requires (more on this below).

3. Slicing

- The process of converting an STL file into G-code is known as slicing. G-code provides printer commands, so slicing converts the geometry data in an STL file into a set of instructions that the printer must follow to print the model. With consideration for temperature range, speed, and extrusion type, slicing provides your printer with instructions depending on nozzle size, filament, and print profile. Many 3D printer manufacturers have their own slicing programmes, such as Ultimaker Cura and Formlabs PreForm. Additionally, you can use outside software like Slicer.

4. Printing

- The easiest stage is printing; all you must do is load your materials, send your file, and push the print button. Most modern 3D printers include cloud-based software that allows you to print remotely or manually by pressing the printer's button. The only

factors to consider are the type of filament, the availability of filament, the use of the proper nozzle for the filament and temperature range, and accurate calibration.

5. Post-processing

- In the case of FFF prints, it isn't necessary to post-process them, unless you want to paint them or smooth them. If you want to smooth FFF and plastic parts to make them look like injection moulded parts, vapour smoothing is the most reliable method. Models printed with an SLA (stereolithography) 3D printer often require curing with UV light to ensure optimal mechanical and visual characteristics.

3.6.4 Step Slicing

The act of converting a 3D model into a set of instructions for the 3D printers is called Slicing. Quite literally, it 'slices' the 3D model into thin layers, and further determine how each layer should be printed (the tool path) to get minimum time, best strength. A slicer software takes a 3D CAD model which is generally an STL format file and converts it into a g-code that gives commands to the printer. Following are the three major types of settings that can be controlled in a slicer software. Figure 3.6.41 and 3.6.42 shows RFID box and RFID lid.

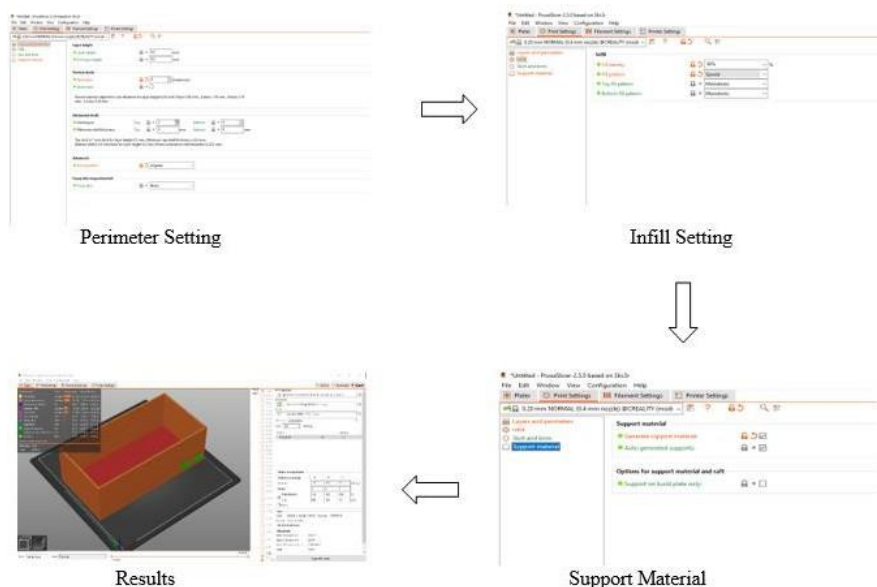

Figure 3.6.41 RFID box

Lid

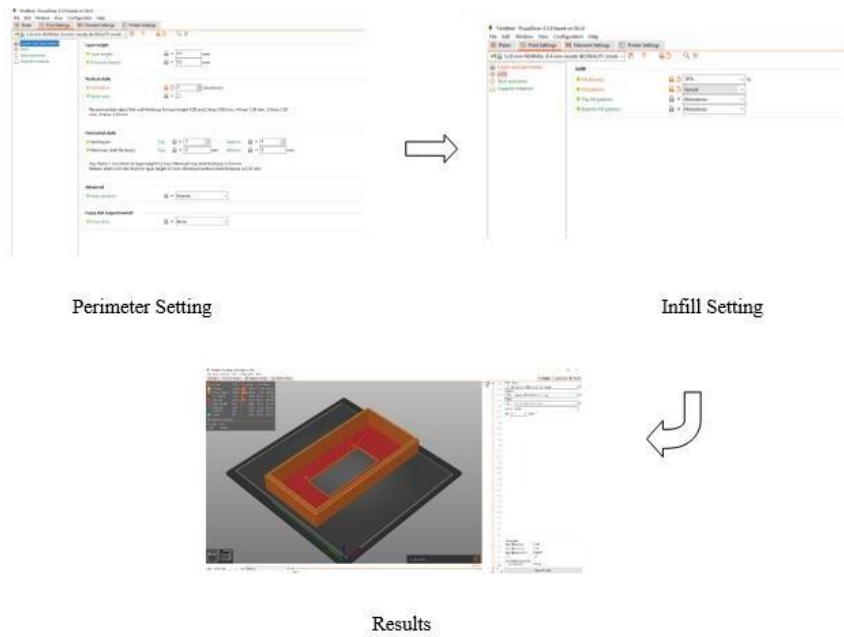

Figure 3.6.42 LID box

3.7 SYSTEM PROGRAMMING

In this segment, the elaboration about step taken to develop the system programme will be described briefly. For a start, as explained earlier in previous section, the programme was develop using several computer programming software such as Arduino IDE Software and MIT App Inventor. Figure 3.28 below showed software used to develop system programme.

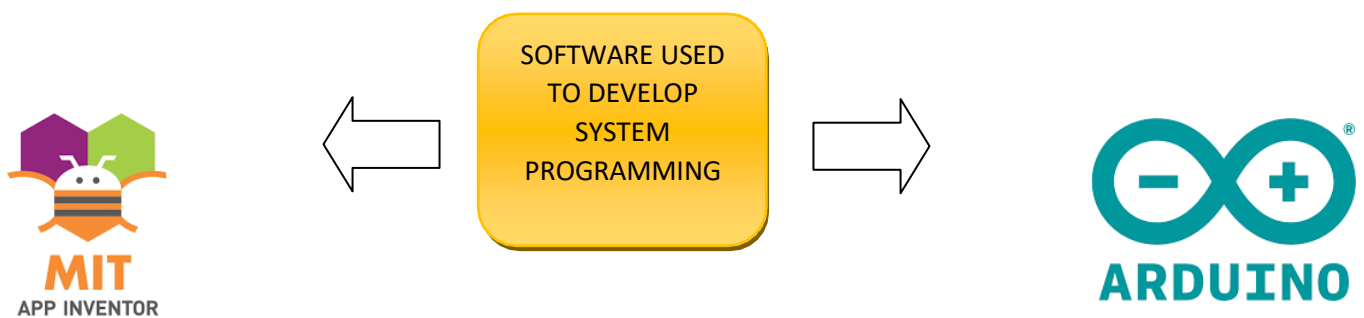

Figure 3.28 Software used to develop system programming

Also, as a student studying in purely mechanical engineering stream, our knowledge about computer programming were shallow and only limited to ourselves and general knowledge. Thus, it is one of our incentives where we seek help from Mr Mohd Ariffin Zulkifli, a professional IOT consultant and trainer which own a company that provide a consultation and training service regarding IOT programming called ‘MyInvent Technologies Sdn Bhd’ nearby to our place. There we learn a lot and were consulted by Mr Mohd Ariffin with a precise knowledge.

“MyInvent Technologies Sdn Bhd” details;

Name of Consultant –	Mohd Ariffin Zulkifli
Phone Number –	+60 17-7875232
Address –	No.7A, Jalan Badminton 13/29, Tadisma Business Park,Section 13, 40100 Shah Alam, Selangor.
Office Number –	+603 5523 5321
Website –	https://myinvent.com.my
Facebook –	MyDuino.com



Figure 3.29 Picture of Mr Ariffin.



Figure 3.30 My Invent Technologies Business card.

3.7.1 Preparing the Device

The first step was to prepare our device by downloading all the needed software. All the necessary's software were easy to download as all of them is an opensource/cross- platform, meaning, it is free and easy for everyone to download through internet.

1. MIT App Inventor 2

Link: <https://appinventor.mit.edu/>

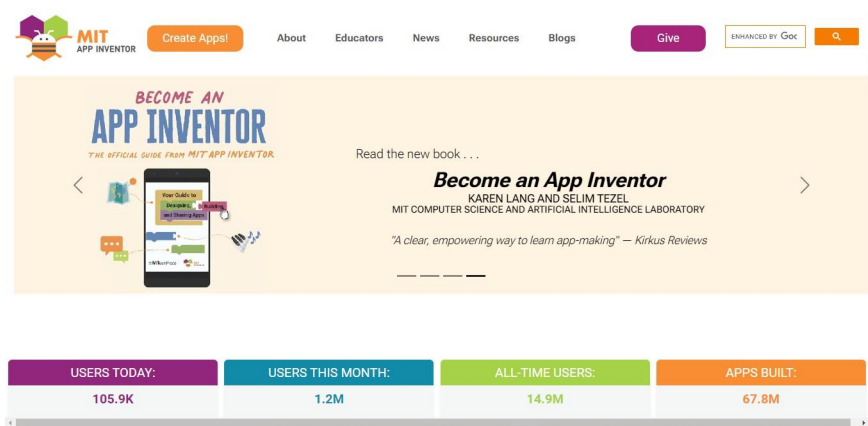

Figure 3.31 MIT App Inventor 2

2. Arduino Ide Software

Link: <https://www.arduino.cc/en/software>

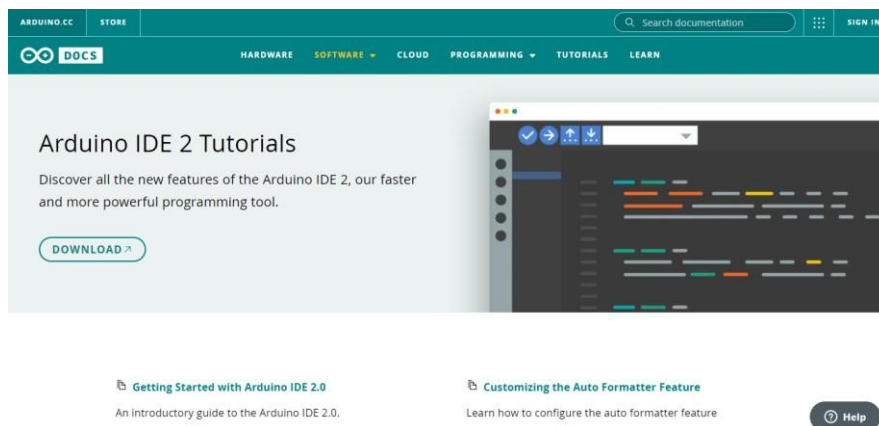

Figure 3.32 Arduino Ide Software

3.7.2 Writing the Computer Language.

This phase was done through the Arduino Ide Software. This consist of writing computer language for three of the main system, which is NodeMcu RFID Reader, NodeMcuRFID Counter Reader, and NodeMcu RFID Reader Wifi. Figure below showed three main system of RFID Device.



Figure 3.33 Three main system of RFID Device

Since our RFID Device used NodeMCU Microcontroller as its main components, thus the main objective in this computer language writing was to construct a computer language which in this case was “Javascript. C Language” which act as an instruction when translated by the NodeMcu Microcontroller. This will set up a chain of command for the microcontroller to give it direction on what needed to be done after one’s action. For example, when the RFID reader detect a RFID Tags, it creates a database management system. Figure below showed sketch sheet for NodeMcu RFID Reader, NodeMcu RFID Reader counter and NodeMcu RFID Reader Wi-Fi system programming



Figure 3.34 sketch sheet

3.7.3 Setting up the MIT Application Inventor 2

1. Open MIT Application Inventor 2 in Google

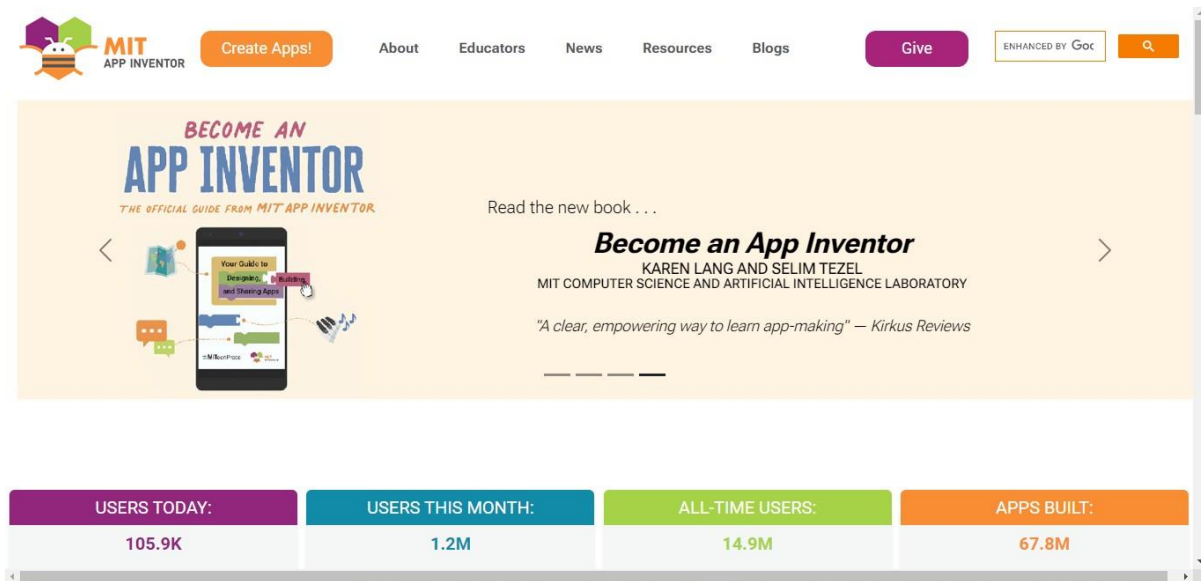

Figure 3.35 MIT Application Inventor 2

2. Next, a display “Create new app inventor project” will appear and name the project “SMART TROLLEY”.

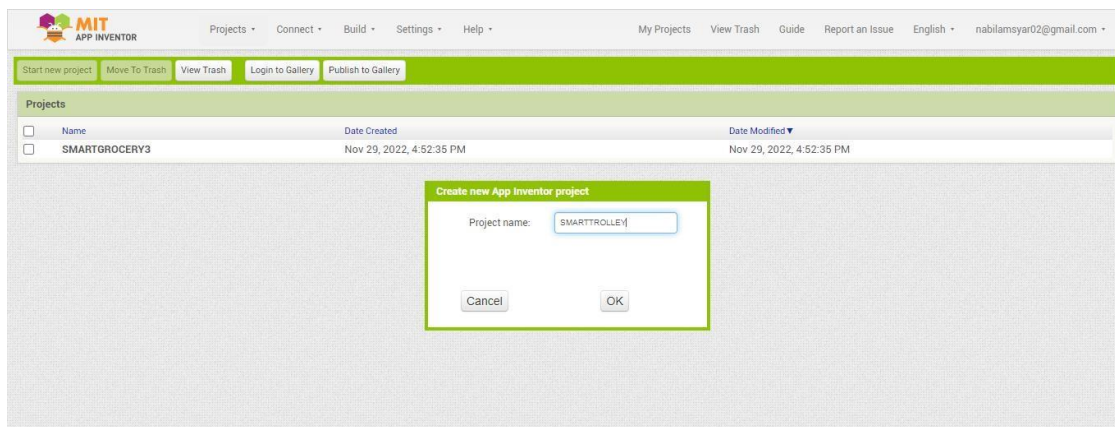

Figure 3.36 Create name project and save project

3. To create a background of Smart Grocery application, insert a photo of trolley.

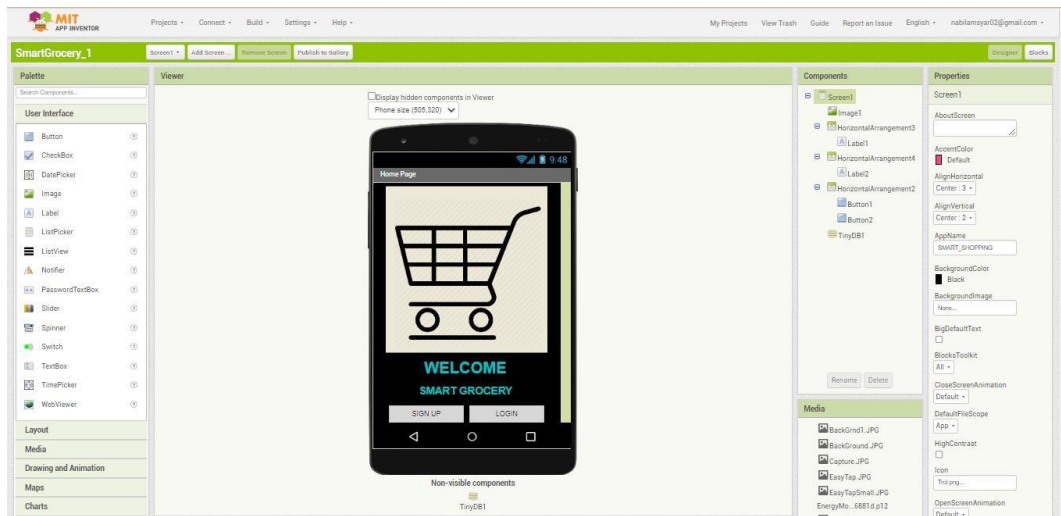

Figure 3.37 Create a background of Smart Grocery Cart Application

4. Then , create a sign up section for customer.

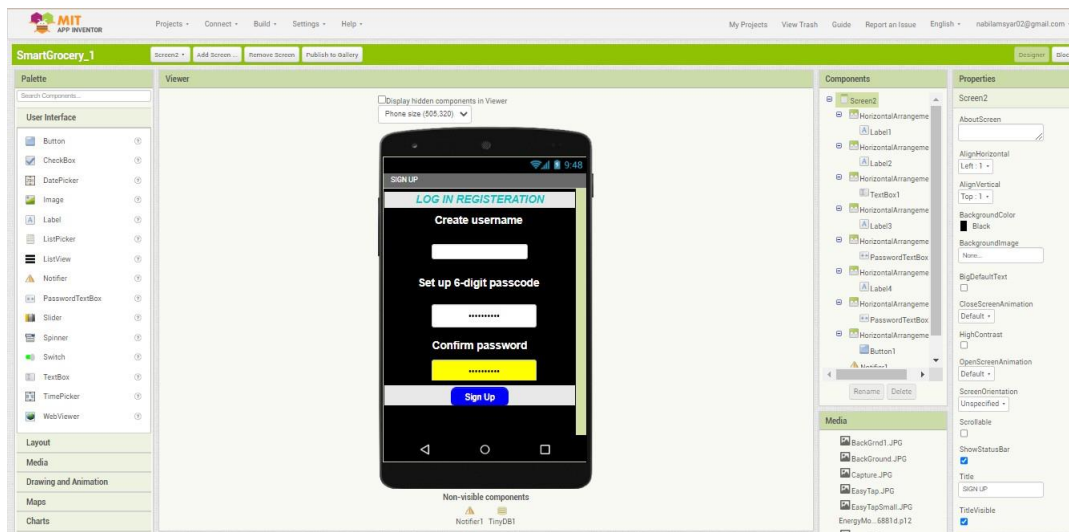

Figure 3.38 Create a sign up section

5. After creating the sign-up section. This is a display of log in section for customers.

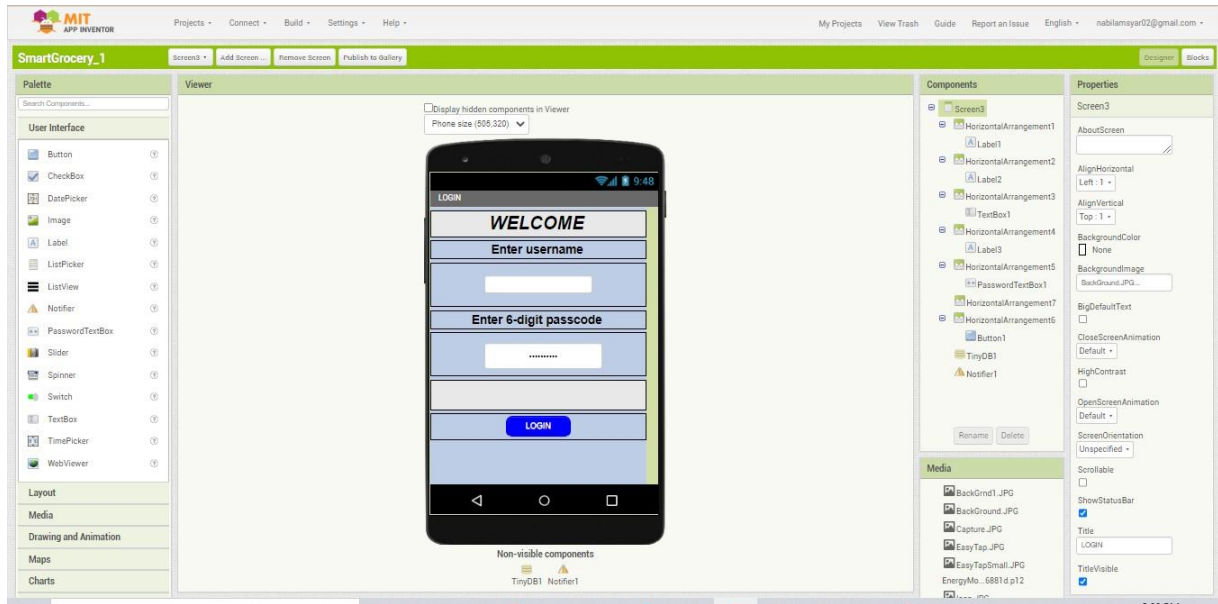

Figure 3.40 Display of log in section

6. Then , a display in the application will appear such as total , quantity and balance.

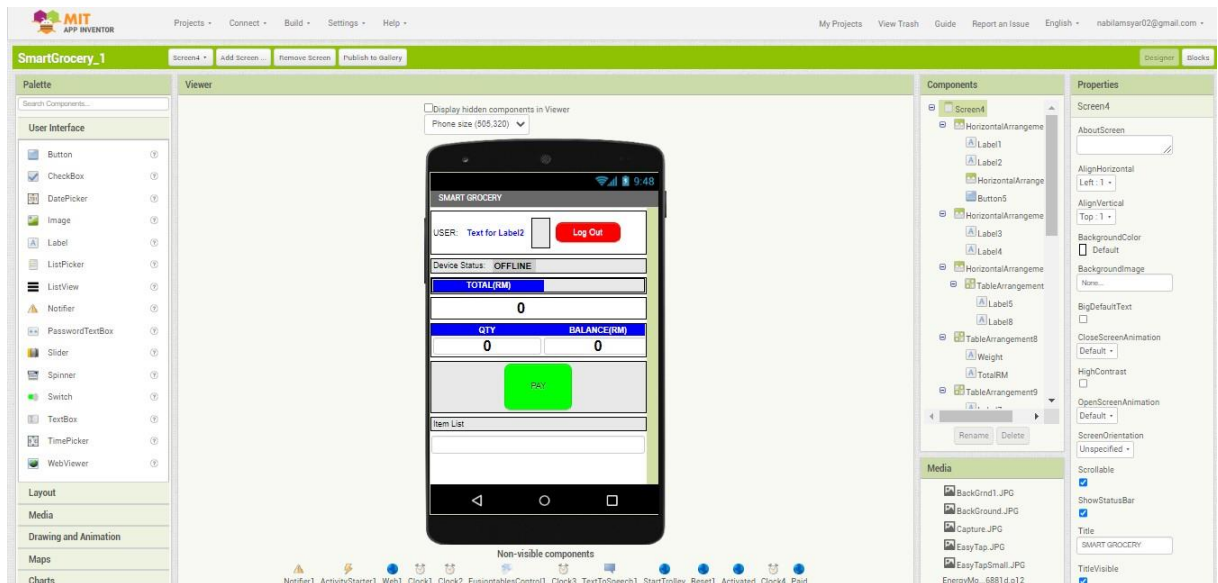

Figure 3.41 Display in the application

3.8 BUDGET CALCULATION

Table 3.3 below is the table of expenses.

No	Materials / Equipment	Amount	Price	Total
1.	100 Litre Grocery Cart	1 unit	RM 175.00	RM 175.00
2.	NodeMCu ESP32 Microcontroller	1 unit	RM 32.90 each	RM 32.90
3.	RFID RC522 Module for Arduino	2 unit	RM 9.90 each	RM 19.80
4.	Bread Board 830 Holes (16.3x5.5 cm)	1 unit	RM 3.90 each	RM 3.90
5.	20cm 40 ways Dupont jumper wire Male to Male	1 unit (40 pieces)	RM 3.70	RM 3.70
6.	Doublepow AA 200mAh NiCd 4.8V Rechargeable Battery	1 unit	RM 12.63	RM 12.63
7.	4.8V USB Charger	1 unit	RM4.40 each	RM 4.40
8.	20cm 40 ways Dupont jumper wire Male to Female	1 unit (40 pieces)	RM 4.60 each	RM 4.60
9.	LCD 1602/2004 16x4 LCD Screen Liquid Crystal Display Module	1 unit	RM 19.90 each	RM 19.90
10.	NFC Tags Sticker (13.56 MHz, Diameter : 25mm)	10 unit	RM 1.00 each	RM 10.00
11.	Push Button	1 unit	RM 1.00 each	RM 1.00
12.	Standard Piezo Buzzer	1 unit	RM 4.90 each	RM 4.90
13.	Arduino UNO	1 unit	RM 32.00 each	RM 32.00
14.	3D Printing	307.04 g	RM 0.20 per gram	RM 61.40
15.	HC-SR04 Ultrasonic Distance Sensor	1 unit	RM 4.90	RM 4.90
Grand Total			RM 391.03	

3.9 PROJECT ACTIVITY (GANTT CHART)

Projected table below illustrates the activity schedule for RFID Grocery Cart project.
 Table 3.4 Gantt chart of project activity.

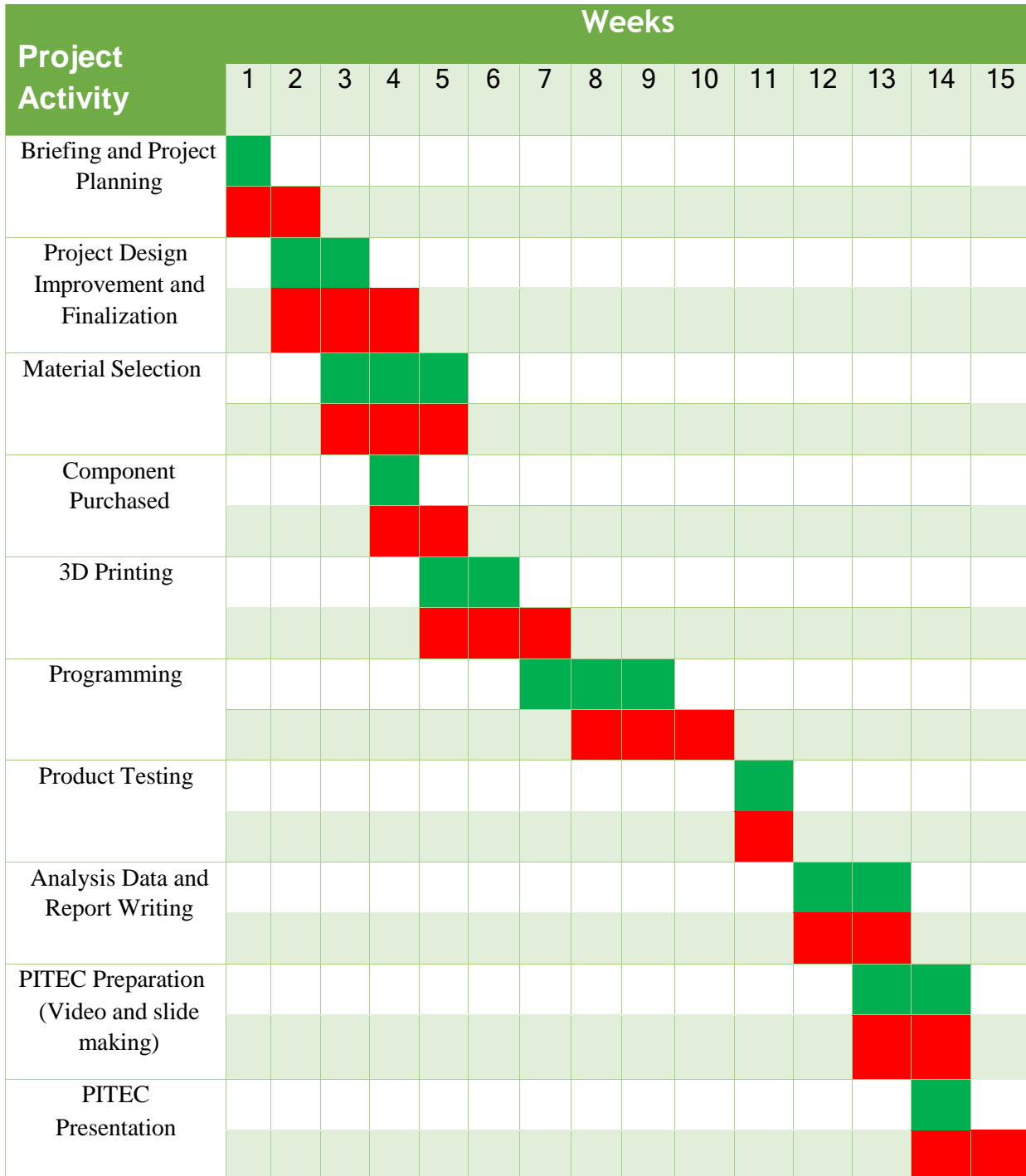

 Planning

 Actual

3.10 Summary

In conclusion, in this chapter, showing the RFID trolley how progress is described and detailed. from the first step of the feasibility study as a preliminary review, to the process of designing the product and developing the system programming. This up to the last process which is the finishing process can be adequately interpreted. In addition, the process in this chapter is carried out in an orderly and systematic manner. this is because in this chapter it follows a methodological trend that shows that the research framework for the smart grocery cart is successful. we are also proud and happy that we were able to complete the project as planned.

CHAPTER 4 FINDING AND ANALYSIS

4.1 INTRODUCTION

In this chapter, it describes the finding of our studies, based on the research objectives and question, and explain briefly the operational of the RFID Grocery Cart. Also, this chapter specify the impact of this project, challenges faces and advantages and disadvantages of this project. Figure 4.1, 4.2 and 4.3 represent RFID device, RFID device lid and RFID device box.



Figure 4.1 RFID device.

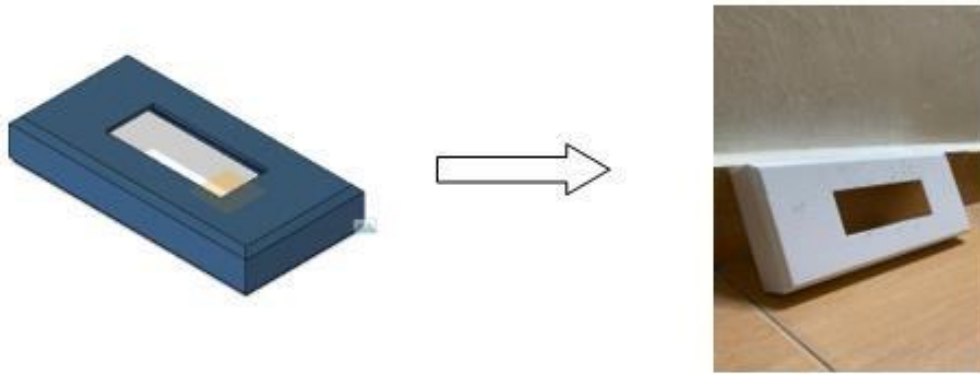

Figure 4.2 RFID Device Lid

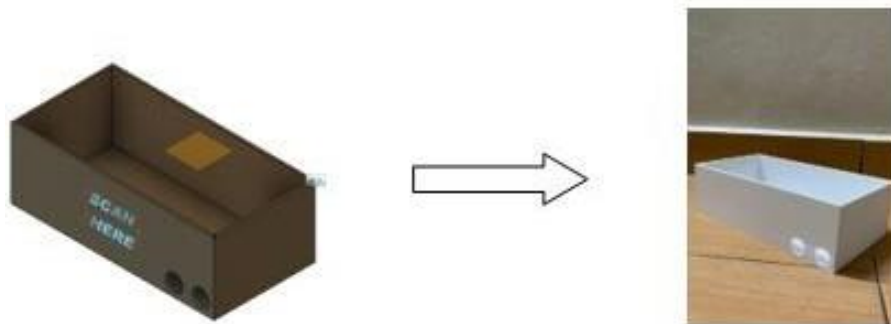

Figure 4.3 RFID Device Box

4.2 PROJECT OPERATIONAL/APPLICATION

This sub-chapter explained the operational of RFID Grocery Cart in the simplest term. Refer figure below.

1) Figure below showed customer scanning RFID tag through RFID Scanner.



Figure 4.4 customer scanning RFID tag through RFID Scanner.

Customers enter the premises carrying a trolley along with the RFID box that has been prepared (provided by the premises). After taking the trolley, customers need to scan the items they want to buy in the section where the scan here sticker has been placed. When customers want to reject the items, they want to buy, they need to press the button that has been provided and instructions will be issued on the LCD screen.

2) Figure below showed the interface between RFID scanner, Microcontroller and Database.

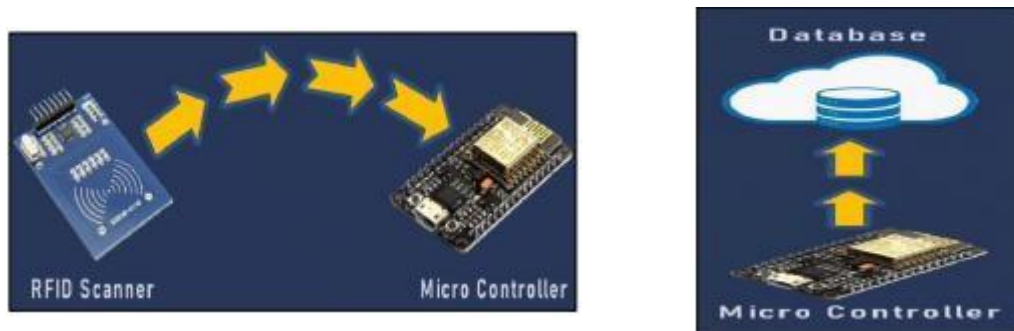

Figure 4.5 the interface between RFID scanner, Microcontroller and Database.

RFID Reader scan information embedded in the tags and send information to NodeMcu Microcontroller. Which translate the information and send this information to Database Management System Software. This set up an item purchased database site which is set up exclusively for that customer only.

3) Figure below showed customer scanning item through RFID Device.

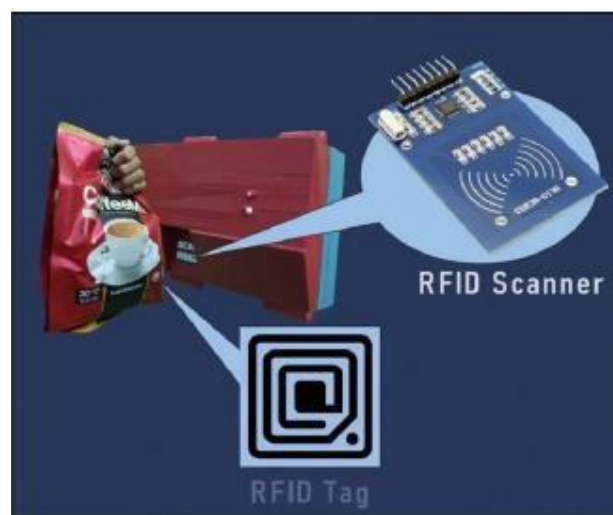

Figure 4.6 customer scanning item through RFID Device.

While moving around premises during shopping activity, customer can scan the item they wish to purchase (that have been attached with RFID adhesive tags) through the same RFID reader attached at the grocery cart.

4) Figure below showed cashier scanning RFID tags through RFID scanner at counter.

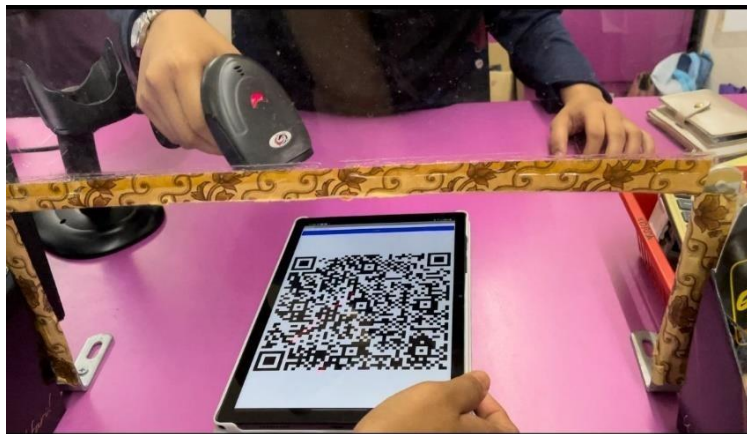

Figure 4.7 cashier scanning RFID tags through RFID scanner at counter.

As customer are done with their shopping activity, customer can head to the cashier counter and hand-over their RFID tags to the cashier. Cashier will scan the RFID tags through a RFID reader located at the cashier counter. This will command the supermarket central billing system to receive input of database from the customer's Item purchased Database.

5) Figure below showed Sum up of collective data with a total price that the customer needs to pay

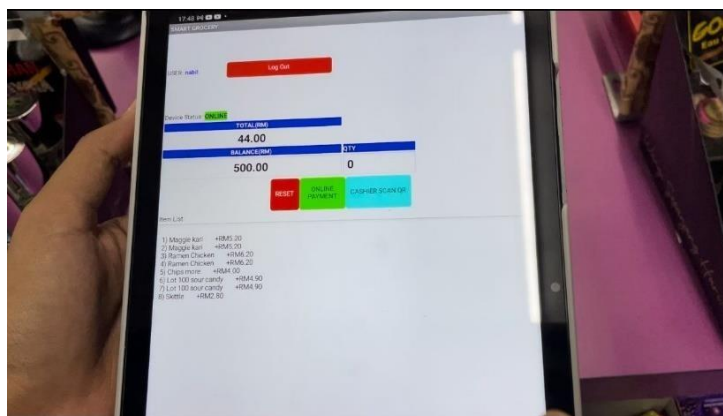

Figure 4.8 Sum up of collective data with a total price that the customer needs to pay

Sum up of collective data with a total price that the customer need to pay will appear at the counter screen. Customer then pay total amount of purchased item through cash or online services.

CHAPTER 5 DISCUSSION AND CONCLUSION

5.1 INTRODUCTION

All research reports seem to end with a set of conclusions. Therefore, you cannot have those before having it to be discussed. Just like in this chapter, we will take a short recap of the entire project with all its content. Having cycled painfully to the top of the hill, the great temptation at this point is to relax and freewheel down to the finish.

5.2 DISCUSSION

There is no question that the Internet of Things (IoT) and Radio Frequency Identification (RFID) technology may function as a single system to benefit society by enhancing the efficiency of food shopping. However, these advantages are only applicable under situations, such as locations without internet access and the technology's usability. As is common knowledge, this technology cannot capture or transfer data from metal surfaces because metal scatters radio waves, which it employs as its medium.

Currently, after buying, most items are placed in the standard grocery cart at other nearby supermarkets or hypermarkets. However, the clients' actual circumstance is when they are making a payment. Customers must transfer and scan each item individually at the checkout desk. This will take a long time because some items need to be carefully checked (typing in the check digit). This innovative RFID grocery cart stores the purchase information on an RFID card, which the cashier scans. In this manner, the checkout process is sped up because only one item needs to be scanned.

5.3 CONCLUSION

In conclusion, the main idea behind this is to help the community in purchasing by shortening the time to queue to make payments. A typical grocery cart does not have the convenience of the project we are producing. By using the RFID system on this grocery cart, it can help customers and cashiers during payment. This makes the payment process faster and more efficient. We believe that RFID technology is not limited to access cards, tolls, clothing but also grocery items. With this technology, we need time to adapt to the use of this technology. This is a great step in the progress of mankind. This is due to being in industrial revolution 4.0. We hope this project can contribute to making Malaysia a great country that can compete with other countries such as China and Japan. RFID Shopping Carts will be the face of the future because of their purpose in everyone's life. We hope that our project will be an inspiration to anyone who is interested in taking this project to a higher level.

REFERENCES

- [1] What is RFID? How It Works? Interface RC522 RFID Module with Arduino.(2020).Retrieved 15 March 2020 from <https://lastminuteengineers.com/how-rfid-works-rc522-arduino-tutorial/>
- [2] A Brief History—and Future—of the Shopping Cart. (2020). Retrieved 9 March 2020,from <https://www.mentalfloss.com/article/26470/briefhistory%E2%80%94and-future%E2%80%94shopping-cart>
- [3] Orla Watson. (2020). Retrieved 9 March 2020, from https://en.wikipedia.org/wiki/Orla_Watson
- [4] McMillan, R., McMillan, R., Knight, W., Edelman, G., Finley, K., & Levy, S. et al. (2020). Microsoft Kinect Games Grocery Shopping at Texas Whole Foods. Retrieved 9 March 2020, from <https://www.wired.com/2012/02/shoppingcart/>
- [5] What is RFID and How Does RFID Work? - AB&R®. (2020). Retrieved 9 March 2020, from <https://www.abr.com/what-is-rfid-how-does-rfid-work/>
- [6] Radio-frequency identification. (2020). Retrieved 9 March 2020, from https://en.wikipedia.org/wiki/Radio-frequency_identification
- [7] What is RFID? - EPC-RFID. (2020). Retrieved 9 March 2020, from <https://www.epc-rfid.info/rfid>
- [8] What is RFID? How It Works? Interface RC522 RFID Module with Arduino.(2020).Retrieved 15 March 2020 from <https://lastminuteengineers.com/how-rfid-works-rc522-arduino-tutorial/>
- [9] ESP8266 NodeMCU (2019). Retrieved 16 March 2020 from <https://cityosair.readme.io/docs/esp8266-nodemcu>

- [10] The Function of Breadboard (2018). Retrieved 16 March 2020 from <https://www.techwalla.com/articles/the-functions-of-a-breadboard>
- [11] What is a Jumper Wire? (2018). Retrieved 16 March 2020 from <http://blog.sparkfuneducation.com/what-is-jumper-wire>
- [12] Active RFID vs. Passive RFID: What's the Difference? (2019). Retrieved 16 March 2020 from <https://blog.atlasrfidstore.com/active-rfid-vs-passive-rfid>
- [13] How do rechargeable (that is, zinc-alkaline or nickel-cadmium) batteries work and what makes the reactions reversible in some batteries, but not in others? (1999). Retrieved 17 March 2020 from <https://www.scientificamerican.com/article/how-do-rechargeable-that/>
- [14] Screw-Machine Components (2016). Retrieved 20 March 2020 from <https://www.britannica.com/technology/screw>
- [15] The PLA Filament Buyer's Guide (2019). Retrieved 20 March 2020 from <https://all3dp.com/1/pla-filament-3d-printing/>
- [16] What is an Ultrasonic Sensor?(2018). Retrieved 12 August 2019 from <https://www.sonotec.com/en/column/ultrasonic.html>.
- [17] What is the working principle of the buzzer?(2020). Retrieved 29 October from <https://www.quisure.com/blog/1/what-is-the-working-principle-of-the-buzzer>.

APPENDIX

APPENDIX A SMART GROCERY CART POSTER

APPENDIX B PITEC 3 2022

APPENDIX C PROJECT RELATED PICTURE

APPENDIX D MYIPO COPYRIGHT



DEVELOPMENT OF SMART GROCERY CART



DR. NORASIAH BINTI MUHAMMAD
norasiah.muhammad@gmail.com



MUHAMMAD NABIL AMSYAR BIN SUDIN
nabilamsyar02@gmail.com



ANIS ZULAIKHA BINTI AZLAN
anszkha17@gmail.com



MUHAMMAD AFIQ SYAHMIE BIN SAADON
afiqsya71@gmail.com

ABSTRACT

The project is applied from an observation based on consumers in supermarkets who must wait a long time to make a payment at the payment counter. The scope of this study focuses on developing and improvising current existing sell and purchase process that uses grocery cart to be quicker and more efficient for both seller and customers. Nowadays, consumers in every local supermarket are having problems where they must line up long and wait for a long time at the checkout counter. This can be clearly seen especially during the festive season, and it has become a heavy burden especially to the elderly who have health problems, those who are in a hurry and those who are carrying babies. This product has been designed and created specifically to facilitate consumers by reducing the time taken when shopping and during the payment process as well as speeding up the payment process while at the payment counter. The design of Smart Grocery Cart RFID Case was designed using Autodesk Fusion 360 Software and was produced using 3D Printing. This project used Arduino system and RFID system for programming. This product is also proven to solve the problems faced by users.

OBJECTIVE

- i. To design a grocery cart with RFID system.
- ii. To create the RFID case using 3D Printing.
- iii. To install the RFID system to the trolley to solve long queue during payment sessions.

METHODOLOGY

- Before the component and material selection, this project started with project research. After that, start the system overview for Arduino programming and RFID system.
- Next, do the product design for RFID Case.
- Then, the product testing for product and analysis the data.
- Lastly, make a report writing for the Smart Grocery Cart project.

PRODUCT DESCRIPTION





- Designed by using Fusion 360
- Material trolley used : Stainless Steel , Hard Plastic , Corrugated pp board.
- Contains in 15 parts.



- RFID Case Box are made by 3D Printing
- Used 9 important component
- Main component is RFID 522 and Arduino UNO

RESULT

Comparison between an old trolley with Smart Grocery Cart.

NO.	OLD TROLLEY	SMART GROCERY CART
1.	Use the payment process normally	Equipped with RFID system to make payment
2.	Takes a long time to make the payment	Saves time to make payments
3.	Not productive	More productive
4.	Low cost	High cost

ORIGINALITY

- MYIPO number : LY2022W04952

CONCLUSION

- The major purpose of this is to facilitate community purchasing by reducing the amount of time required to wait in a payment line. The convenience of the project that built is not found in a conventional grocery cart.
- This shopping cart's RFID device can assist both customers and cashiers during the payment process. This expedites and improves the payment procedure.
- Supermarket items can also give benefit from RFID technology. In addition to access cards, tools, and apparel.

POLITEKNIK SULTAN SALAHUDDIN ABDUL AZIZ SHAH
KEMENTERIAN PENDIDIKAN MALAYSIA
Persiaran Usahawan, Seksyen U1,
40150 Shah Alam
Selangor, Malaysia
Tel.: 603-51634000
Faks.: 603-55691903

SMART GROCERY CART POSTER



PITEC 3 2022 (ANUGERAH KHAS JURI)



PITEC 3 2022 (3rd PLACE)

APPENDIX C

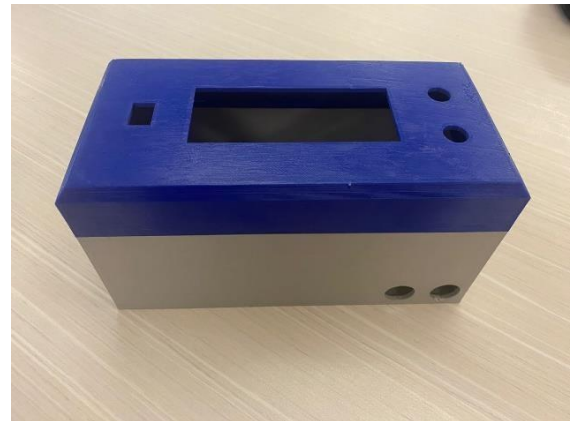
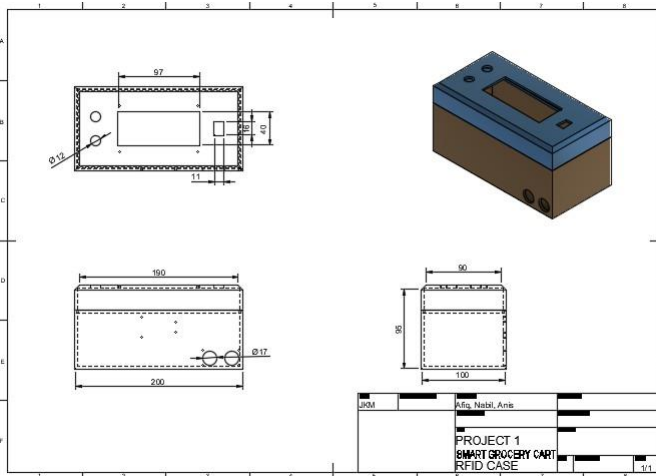

PROJECT RELATED PICTURE



INTELLECTUAL PROPERTY CORPORATION OF MALAYSIA
An agency under the Ministry of Domestic Trade and Consumer Affairs
COPYRIGHT ACT 1987
NOTIFICATION OF COPYRIGHT IN A WORK
[subregulations 5(2) and 5(3)]



Copy



CR - 1

DANA HARTA INTELEK

Application No:
LY2022W04952

Applicant :

*Title of work (Original language) : SMART GROCERY CART

Translation (If the title of work is neither in Bahasa nor English) : _____

Transliteration (If the title of work is neither in Bahasa nor English) : _____

Name of the Language (Language use in the work) : ENGLISH

***Section A : Category of Works (Please tick only ONE category of work in item (i) or (ii))**

(i) Copyright Work

Literary Musical Artistic Film Sound Recording Broadcast (Applicable only for broadcasters)

(ii) Derivative Work

Translation Adaptation Arrangement Collection of work or compilation of mere data (database) Other transformation of work eligible for copyright

Date of Creation / Fixation : 29 / 08 / 2022

Section B : Publication

The Work is : Published Unpublished

If published (please state date first published) : _____ (Year of Compilation) 29 / 08 / 2022 (Date of first publication) MALAYSIA (Country)

***Section C : Author** (Note : i. Author is an individual person, not a company. To add additional authors, please attach separate sheet. ii. If author is anonymous, please state name of legal representative)

Name : REFER ATTACHMENT

I.C / Passport No. : _____

Address : _____

Postcode : _____ City : _____ Nationality : _____

State : _____ Country : _____

E-mail : _____ Date of Death : _____

Telephone No. : _____ Fax No. : _____

PAGE 1 OF 3

* Required to be filled in

MyIpo Copyright Paper

Application Number : LY 2022W04952