



DJJ40182 PROJECT 1

DJJ50193 PROJECT 2

829

FINAL REPORT :
DEVELOPMENT OF KITCHEN FIRE SYSTEM

DMP5A

NAME	MATRIC NUMBER
SITI NURSYAKIRA BINTI MOHD ANUAR	08DMP19F2002
NUR AINA SOFEA BINTI AZALI	08DMP19F2003
FARAH IZATIE BINTI JAFERIDIN	08DMP19F2004

SUPERVISOR:

DR MOHD ELIAS BIN DAUD

JABATAN KEJURUTERAAN MEKANIKAL

SESI 2021/2022

POLITEKNIK SULTAN SALAHUDDIN ABDUL AZIZ SHAH

DEVELOPMENT OF KITCHEN FIRE SYSTEM

NAMA	NO. PENDAFTARAN
SITI NURSYAKIRA BINTI MOHD ANUAR	08DMP19F2002
NUR AINA SOFEA BINTI AZALI	08DMP19F2003
FARAH IZATIE BINTI JAFERIDIN	08DMP19F2004

**Laporan ini dikemukakan kepada Jabatan Kejuruteraan Mekanikal
sebagai memenuhi sebahagian syarat penganugerahan Diploma
Kejuruteraan Mekanikal**

JABATAN KEJURUTERAAN MEKANIKAL

SESI 2021/2022

ACKNOWLEDGEMENT

Alhamdulillah, In the name of Allah the most gracious and the most precious, first and foremost , I would like extend our deepest praise to Allah SWT who given us the patient, strength, determination, obstacle that helping us to think wisely in making a decision and courage to completed this project .Plus , many thanks and highest gratitude to Dr Mohd Elias Bin Daud , our supervisor , which helps , lead and guides us with our project “Development Of Kitchen Fire System”.

ABSTRACT

When cooking on a gas stove, the food or oil in the pot or pan may catch fire due to the high temperature. Furthermore, people may be unsure if they turned off the gas stove before leaving home and thus feel forced to come home to double-check. To address these issues, researchers created a smart kitchen fire prevention system with the following devices and functions. Above the stove, sensors are mounted. They immediately engage the gas shutoff device to switch off the gas supply when they detect flames, excessive temperatures, or a gas leak. To alert residents, the alarm emits a loud sound and lights. The Line reporting system transmits line messages to residents and the community management centre, and the main entrance door is unlocked automatically to allow relevant employees to enter the residence to deal with the mishap. In the kitchen, an Internet protocol camera has been installed so that inhabitants may monitor the gas burner using their mobile phones. If the gas stove is still turned on, they can use their phones to activate the gas cut off device, which will turn off the gas supply. The conclusion is the design and implementation of the Kitchen Fire System is adaptable and flexible based on our project. This wireless detection technique is more cost effective than the typical market's current fire detection devices. This Kitchen Fire System detection framework has a high precision rate and responds quickly. All upgrades will be performed in order for this project to provide additional benefits and advantages. I hope that this initiative will continue to grow in scope for future generations. Last but not least, the approach created in this study can significantly reduce the amount of money lost as a result of a kitchen fire.

Keywords: flame detector, sensor; fire extinguisher

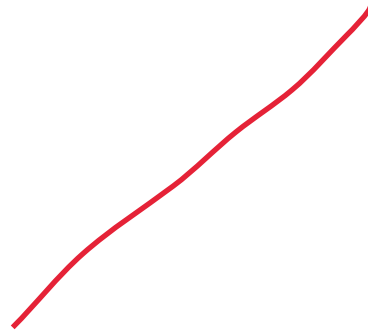

ABSTRAK

Apabila memasak di atas dapur gas, makanan atau minyak dalam periuk atau kualiti mungkin terbakar kerana suhu yang tinggi. Tambahan pula, orang ramai mungkin tidak pasti sama ada mereka menutup dapur gas sebelum meninggalkan rumah dan dengan itu berasa terpaksa pulang ke rumah untuk menyemak semula. Untuk menangani isu ini, penyelidik mencipta sistem pencegahan kebakaran dapur pintar dengan peranti dan fungsi berikut. Di atas dapur, sensor dipasang. Mereka segera menggunakan peranti penutup gas untuk mematikan bekalan gas apabila mereka mengesan api atau kebakaran, suhu berlebihan atau kebocoran gas. Untuk memberi amaran kepada penduduk, penggera mengeluarkan bunyi dan lampu yang kuat. Sistem pelaporan Talian menghantar mesej talian kepada penduduk dan pusat pengurusan komuniti, dan pintu masuk utama dibuka secara automatik untuk membolehkan pekerja yang berkaitan memasuki kediaman untuk menangani kemalangan itu. Di dapur, kamera protokol Internet telah dipasang supaya penduduk boleh memantau penunu gas menggunakan telefon bimbit mereka. Jika dapur gas masih menyala, mereka boleh menggunakan telefon mereka untuk mengaktifkan peranti pemotong gas, yang akan mematikan bekalan gas. Kesimpulannya ialah reka bentuk dan pelaksanaan Sistem Kebakaran Dapur boleh disesuaikan dan fleksibel berdasarkan projek kami. Teknik pengesanan wayarles ini lebih menjimatkan kos berbanding peranti pengesanan kebakaran semasa pasaran biasa. Rangka kerja pengesanan Sistem Kebakaran Dapur ini mempunyai kadar ketepatan yang tinggi dan bertindak balas dengan cepat. Semua naik taraf akan dilakukan agar projek ini memberikan faedah dan kelebihan tambahan. Saya berharap agar inisiatif ini akan terus berkembang dalam skop untuk generasi akan datang. Akhir sekali, pendekatan yang diwujudkan dalam kajian ini dapat mengurangkan jumlah wang yang hilang dengan ketara akibat kebakaran dapur.

Kata kunci: pengesanan kebakaran, sensor; alat pemadam api



CONTENT

CHAPTER	CONTENTS	PAGES
	FRONT PAGE	
	ACKNOWLEDGEMENT	
	ABSTRACT	
	ABSTRAK	
	CONTENTS	
1	INTRODUCTION	
	1.1 Research Background	8-9
	1.2 Problem Statement	10
	1.3 Research Objectives	10
	1.4 Research Scope	10
	1.5 Significance of Research	11
	1.6 Chapter's Summary	11
2	LITERATURE REVIEW	
	2.1 Introduction	12
	2.2 Advantages of Kitchen Fire System	13
	2.3 Concept / Theory	13
	2.4 Previous Research	14-17
	2.5 Summary of chapter	17

3	METHODOLOGY	
	3.1 Introduction	18
	3.2 Flow Chart	19
	3.3 Flow Chart Explanation	20-21
	3.4 Project Design / Schematic circuit	22-28
	3.5 Compenents	29-36
	3.6 Budget Calculation	37
	3.7 Project Activity	38-40
	3.8 Chapter's Summary	41

4	FINDINGS AND ANALYSIS	
	4.1 Introduction	42
	4.2 Analysis	42-45
	4.3 Advantages and Disadvantages	45
	4.4 Chapter's Summary	45

	Conclusion	46
	References	47

CHAPTER 1

1.1 INTRODUCTION

Kitchen Fire System is an automatic fire prevention system designed to protect an area related to the kitchen. The system is easy to use heat and flame sensors. Where these sensors will detect heat and flame during a fire in the kitchen. The system is installed in commercial catering facilities across various types of premises including restaurants, houses and other similar facilities. This project uses the concept of IoT. Such an application has been installed to connect an individual aware of a fire that occurred unexpectedly during their absence on the premises.

Kitchen Fire System is an active fire protection device used to extinguish fires that occur in the kitchen. An extremely basic fire extinguisher will be leading to anxiety or panic situation during emergencies because, normally the existing fire extinguisher is not designed to function automatically and it has to be handled manually. The main objective of this project is to identify the problems in the existing fire extinguisher system and to investigate how to solve physical fire extinguishers problems such as way of carrying and method of use.

The Kitchen Fire System is a device that automatically extinguishes the flames developed for use in a fire extinguisher that can be turned on and off automatically put out the fire using the sensor heat and fire sensor that was installed in the building device. To get feedback on the project, a survey was done and the results were positive. Positive responses from respondents are referred to as reviews. The system that will be created after that will be put to the test for both safety and suitability. It is hoped that it will help appreciate the concept to society, especially in dire situations. Next, fire systems come with a variety of different extinguishing agents inside of them. Each different formula is designed to deal with a different class of fire which are dry powder, wet chemical, foam, water and CO₂.

1.1 RESEARCH BACKGROUND

Fire occurrences are uncommon, but when they do occur, they can result in significant losses, such as lives lost and significant property damage, if the fire is not put out quickly. Incidents of fire can occur at any time and in any location. Basically, there are a few different sorts of fire events that occur often. Kitchen fires, electrical fires, heater fires, and smoking-related fires are all examples of fires. Incidents involving fire are also common. The materials involved in the incident have been categorised. The classes are as follows:

Class A - fires involving solid materials such as wood, paper or textiles.

Class B - fires involving flammable liquids such as petrol, diesel or oils.

Class C - fires involving gases.

Class D - fires involving metals.

Class E - fires involving live electrical apparatus. (Technically 'Class E' doesn't exist however this is used for convenience here)

Class F - fires involving cooking oils such as in deep-fat fryers.

Electrical fire situations are more risky to tackle than other types of fires since they can result in injuries and even death if not handled properly. Kitchen fires, on the other hand, are extremely deadly. Kitchen fires are the most common cause of house fires. Flames and injuries caused by fires in the house. Not only that, but they have the potential to cost tens of thousands of dollars. Setting our house on fire can cause property damage, but there is also the danger of incurring burns. Our family or neighbours may suffer injury or even death as a result of our actions. Kitchen fire safety is an important issue.

More than any other room in the house, people come home first to the kitchen. Unattended cooking is a major contributor. Unattended cooking is one of the leading causes of fires in households throughout the world. Cooking fires account for 47% of all kitchen fires, 20% of civilian deaths, and 45% of all fires injuries. High temperatures in the deep fryer, as well as highly flammable liquids, are common causes of kitchen fires. fat deposits in the flue, dangerous vegetable oils, aged, more flammable oil, in the deep fryer owing to equipment on wheels being relocated, including ventilation ducts, misplaced sprinklers around and sprinklers that aren't working because the fusible connections are coated with grease.

Since kitchen fires are dangerous and difficult to put out, an appropriate equipment to do so should be used, and that appropriate device is the Automatic Fire Diffuser. It is a gadget that is created particularly to prevent fires from arising in the kitchen. This Automatic Fire Diffuser combines the functions of a fire extinguisher and a diffuser into one gadget that may be operated automatically to put out a fire using a smoke and fire sensor. Because this is a device with a diffuser function, the air flow from the diffuser is at a rapid pace because the diffuser's buzzer is narrow and causes high pressure, causing ABC dry powder to be released at a high rate. Moreover when there is fire in the kitchen apart from controlling it this could also send the information to our smart phones immediately.

1.2 PROBLEM STATEMENT

Kitchen fire system prototypes are extremely important since the fire extinguisher used by people now does not have any improvements in the designation that might alleviate the difficulties that people have when suppressing the fire. Because the conventional fire extinguisher is not meant to work automatically and must be handled manually, individuals will experience worry or fear during an emergency.

Kitchen fire system are heavy and difficult to lift. This is because the fire extinguisher is not a light weight tool even it comes with different size. Women and children may be unable to lift the fire extinguisher due to its weight, and emergency situations, particularly those involving fire, can lead individuals to become exceedingly panicked, with their only thought being to get out of the situation. When using a fire extinguisher, there is a procedure called PASS that must be followed in order from first to last. During an emergency, people may forget this and thus be unable to use the fire extinguisher, which may result in the spread of fire, resulting in the loss of lives and significant property damage.

When users are preoccupied, they may forget that anything is cooking on the stove. When a pot or pan boils dry, a detecting device is needed to detect the high temperature and sound or light alerts to alert homeowners and neighbors. Many fires occur due to cause residential buildings in the cooking area. No specific requirement by the fire department such as don't have a fire extinguisher and sensor at home.

1.3 OBJECTIVE

The objectives to this research are :

- i. To identify the problems in the existing fire system.
- ii. To develop a design to ensure early action is taken to extinguish the fire.
- iii. To design a system that makes it easy for users.
- iv. To make sure the system has alarms to detect fire and smoke .
- v. To make sure this system automatically extinguishes fires.
- vi. To send notification automatically to the owner and fire department.

1.4 RESEARCH SCOPE

The scopes and limits to this research are:

- i. This product can be refilled and used rapidly.
- ii. This product is light in weight.
- iii. This product is not a water resistance.
- iv. High sensitivity to detect smoke and flame.
- v. Could last for a long time with a good care.

1.5 SIGNIFICANCE OF RESEARCH

During our research, we discovered that most homes and buildings were equipped with manually operated fire extinguishers; however, the current fire extinguishers are hefty and cannot be hoisted by everyone due to their weight. Aside from that, when children are near a fire extinguisher, it is unsafe since the dry powder is toxic. Furthermore, the risk of injury is larger when manual handling is included. As a result of this analysis and research, we chose to employ an Arduino, a motor, and a sensor to detect fires as they occur, which is safer and more alert than the old way. Moreover, our product is more innovative, and quality is critical in order for it to be outstanding and beneficial in the future.

1.6 CHAPTER'S SUMMARY

In this chapter, the studies was explained about its origin of ideas and inspirations. All of the problem statements were used to create all of the objectives. The goal of this project, as well as the significance of our automatic fire diffuser, which is more safe and easy to handle under high sensitivity. The project's scope is mainly focused on the product's operational efficiency. Overall, the cost of fire may be decreased with the aid of our product, and a similar degree of safety can be achieved by numerous techniques.

CHAPTER 2

LITERATURE REVIEW

In this chapter, will be shown types of method of use during fire occurrence. These types of method have its own advantages. Hence, all the characteristics of those materials will be compared to our own product which has its own specialties and benefits.

2.1 INTRODUCTION - (Diyan,2019)

A fire system is an active fire protection device used to extinguish or control small fires, often in emergency situations. With dry chemical extinguishers, nitrogen is typically used; water and foam extinguishers typically use air. Stored pressure fire extinguishers are the most common type.

Since fire system are our first line of defense in the event of fire:

- Fire extinguishers must be kept clean to be visible.
- Fire extinguishers must be kept easily accessible.
- Correct any deficiencies, such as depleted pressure or blocked nozzles.
- Be sure to conduct regular and thorough inspections of your fire extinguishers.

2.2 ADVANTAGES OF KITCHEN FIRE SYSTEM - (AMSL ,2021)

Kitchen Fire System is important whether the incident occurs in a restaurant or your own home, keeping fire extinguishers on-site can make all the difference in preventing small fires from turning into a four-alarm blaze. But do you really understand the full impact of this fire protection equipment? Here is the 3 main point benefits of Kitchen Fire System:

i. It's Easy To Install

Fire suppression systems come with easy-to-follow instructions for installation. As a result, you should install a fire alarm system in your home to protect yourself and your family from the dangers of fires, which can be fatal if not caught quickly enough or left unattended for an extended period of time. You take control by installing a system that is monitored 24 hours a day that will dispatch emergency services as soon as they are notified. You may have a kitchen, but you lack the necessary equipment. There are numerous reasons why you might consider adding one. They not only protect you and your loved ones from harm or death in the event of an emergency, but they can also help you save money on insurance premiums and reduce your risk of liability claims.

ii. Give An Early Warning

For your own piece of mind, you should install a fire suppression system in your kitchen. It can provide you an early warning if there is smoke or flames, as fire and heat detectors will alert you before things get out of hand. Automatic sprinklers are another option for swiftly and effectively putting out flames. This fire alarm can wake up sleeping youngsters and give them enough time to flee, as well as warn neighbours to a problem.

iii. Help You Avoid Tragedy

If your kitchen has kitchen fire suppression equipment, it is the greatest approach to avoid fires. Fire sensors can detect heat and fire, allowing you enough time to flee before the flames spread too far. If you have a gas leak or a malfunctioning heating system, a carbon monoxide detector can alarm you.

iv. Above the stove top, a sensor is attached. The automatic shutdown device will be activated to shut off gas supply to the stove if it detects excessively high flames or temperature, or if it detects a gas leak.

v. The accident is then reported to the family members and the community management centre via Line, a messaging app, and the main entrance door of the house in issue is automatically opened, allowing emergency services to enter and put out the kitchen fire.

2.3 CONCEPT / THEORY - (Mal, 2021)

We decided to change from Arduino Uno to Arduino Mega 2560 because Arduino Mega 2560 has more interface and compared to Arduino Uno instead. Arduino Mega 2560 have more “female slots” than Arduino Uno that brings Arduino Mega is more stable to used to complete our IOT system that also need to be use ESP8266 Wifi Module that can connect product to our smartphones. The ESP8266 will be included in the circuit to ensure the product can be connected to a smartphone to know when a fire occurs.

2.4 PREVIOUS RESEARCH

An IoT system consists of sensors/devices which “talk” to the cloud through some kind of connectivity. Once the data gets to the cloud, software processes it and then might decide to perform an action, such as sending an alert or automatically adjusting the sensors/devices without the need for the user.

- 1) Fire system is a helpful system prevent fires from occurring and control fires from spreading to a level that can no longer be controlled. This system is a system that very important in the event of a fire. Hence the inspection and testing of this fire equipment must be carried out and maintained in accordance with established safety procedures (Affandi, 2013). With this system is in the building, so it can protect and save the lives of the occupants of the building. The fire prevention system is divided to two namely the passive prevention system and the active prevention system.
- 2) This active prevention system is a system that acts as a warning, detection, extinguishing, and fire control. There are several components of a fire prevention system that need to be installed on the kitchen in accordance with the Uniform Building By-Laws. These components include fire prevention systems and alarm systems such as portable fire extinguishers and heat detectors (Ridzuan, 2008).
- 3) According to the Architecture and Building Research Institute of the Ministry of the Interior's Exploration of Causes of Housing Fires in Taiwan, there were 16,389 fire occurrences in Taiwan in 1999, with building fires accounting for 36.1 percent of the total, or 5,913 cases. Furthermore, house fire incidents accounted for 61.3 percent of all building fire events in Taiwan, with 3,626 occurrences, demonstrating a significant percentage of dwelling fire incidents among all fire incidents in Taiwan. Micro System Technologies (MST) uses the term "Smart Sensors" to describe sensors that have both sensing and signal processing capabilities, with goals ranging from simple viewing to sophisticated remote sensing, surveillance, search/track, weapon guidance, robotics, perceptron, and intelligence applications. The Internet of Things is a collection of services and apps that integrate these technologies into everyday life (IoT)

- 4) To safely flee a fire and extinguish the fire source, the fire must be discovered early on. The most convenient approach to detect a fire early and save losses is to establish a fire alarm system. Fire alarms are made up of a variety of devices that work together to detect fire and alert people via visual and audio devices. The detection equipment (heat, smoke, and gas detectors) detect events and automatically activate the alarm, or the alarms are occasionally manually actuated. Bells, mountable sounders, or horns can be used as alarms.

2.5 FIRE SAFETY IN THE KITCHEN

The kitchen is potentially the most hazardous room in the home. There are hot surfaces, naked flames, plentiful supplies of fuel, electrical appliances, lots of materials which can burn and scald and so on. There are plenty of potential distractions, also with regards to children, telephones, televisions/radios, neighbours, washing machines, and the list goes on and on!

It is important to have:

- a "safe work" practice, to avoid distractions
- a Fire Blanket and Fire Extinguisher
- a fully stocked First Aid kit

Characteristics of included studies :-

- 58 elderly residents, To examine the fire safety awareness and practices of a group of older people in a Nursing home. 40% felt they were not at risk of fire. 28% of people will try to find a fire source instead of an escape from the building. The building fire plan was known to just 42% of the population. The fire alarm was ignored by 12% of residents and could not be heard by 35%. (David Jaslow, 2005 USA)
- 15 heads of the family , To explore the situation, risk, and vulnerabilities of fire hazards and investigate Bihari camp's fire preparedness. This research stated that inadequate preparedness existed among slum people. Almost 95% of people do not take any mitigation approach for reducing the risk of fire. In the Kurmitola Bihari Camp, this is a matter of concern that most of the people were ignorant about fire safety mechanisms and management systems. (Nazia Naoshin, 2020 Bangladesh)

- 300 college students, To explore and identify disaster influence on stress, anxiety, and depression among students and how they cope with it. An insignificant (assuming any) relationship exists between perceived danger and readiness among the individuals who revealed low degrees of self-adequacy. Results propose that self-visibility and saw danger work together to encourage people with physical incapacities to find a precautionary way to diminish the consequential unfriendly health impacts of natural and human-made catastrophes. (Eunmi Lee, 2019 South Korea)

A review of various examples is presented in Table, which offers an overview of five distinct reports about fire events in residential buildings to assist better understand the causes of typical fire accidents and their spread. The chart shows that the majority of the structures reported were not equipped with sufficient fire protection measures. According to the data in the table, the major cause of increased injury and damage in fire occurrences is the spread of flames and smoke from the fire source to other locations. The most intriguing aspect of the research is that, while fire alarm devices can play an important role in occupant safety, they require a supplementary fire protection system.

Fire report	Damage and injury	Reason of damage	Existing Fire protection system	Fire safety problem
Fire incident involved a 6000 square foot two-story single family residence with a full basement that was built in 1998-Kansas (NIOSH 2011)	1 killed, roof collapse, wooden walls and doors	Spread smoke and fire from roof, open doors and corridors	Fire alarm	lack of an adequate fire sprinkler system and isolated places against fire spread
Fire in small house one-story with wooden frame structure in Danville (McGee 2015 [News-Gazzete 4/28/2015])	Destruction of front and roof of the house	Occupant was asleep and fire has spread from kitchen to rooms	non-equipped	lack of a fire alarm to awaken the occupant or alarm nearest fire-office

Fire incident in a residential building in Peekskill-Cortland, NY (Pappas 2015)	Destruction of building envelope	Spread fire from open windows to building envelope	non-equipped	lack of fire sprinkler system or fire proof paint on the building envelope
A fire spread test from masonry walls (Mulligan Products 2015)	Melting plugs behind of the wall	Spread fire from small holes of the plugs in the wall	non-equipped	lack of fireproof box for plugs
Fire in a residential building (Hevern 2011)	Burning sofa	Fire was controlled by sprinkler top of the sofa	Fire alarm and sprinkler	lack of isolated places against smoke spread

Table : Sample of past fire incidents and test in buildings.

2.6 SUMMARY OF CHAPTER

Fire prevention system is one of the safety systems in a residential kitchen itself. In line with world technological advancement, this fire prevention system has been expanded its usefulness. This encouragement is to help users detect the start of a fire and prevent it from ranking early. Accordingly, every user need to have awareness with respect to the importance of consumption fire prevention system in each kitchen.

CHAPTER 3

METHODOLOGY

3.1 INTRODUCTION

Methodology is a 'contextual framework' for research, a coherent and logical system based on perspectives, attitudes, and values that directs researchers' [or other users'] decisions." A description of the underlying logic for the usage of specific approaches is referred to as methodology. This discussion comprises defining the theoretical concepts that guide the method selection, situating the method selection within the larger context of academic work, and assessing its relevance to the research challenge. A full assessment of the ways other scholars have used to examine the topic is also included in the methodology section. This important chapter explains in detail the samples, instruments, materials, procedures and data gathering methods used in the research.

Methodology is intimately linked to the technique, as is the usage of flow charts to depict the progress of a project. The flow chart is essential for illustrating the sequence of actions required to complete the task. In most cases, the flowchart is created in the early phases of the project. It will direct you in completing the tasks. Meanwhile, the Gantt chart shows how the project is planned and seen instantly whether the project is behind or ahead of the schedule. The Gantt chart's purpose is to lead you in the right path for your project. As a result, these two charts are critical in assisting us in completing the tasks. Gantt charts may also be used to show the activities that were completed within the project's implementation time. As a result, all of the implementation phases, chart flow and gantt charts, as well as component descriptions, will be covered in more depth in this chapter.

3.2 FLOW CHART

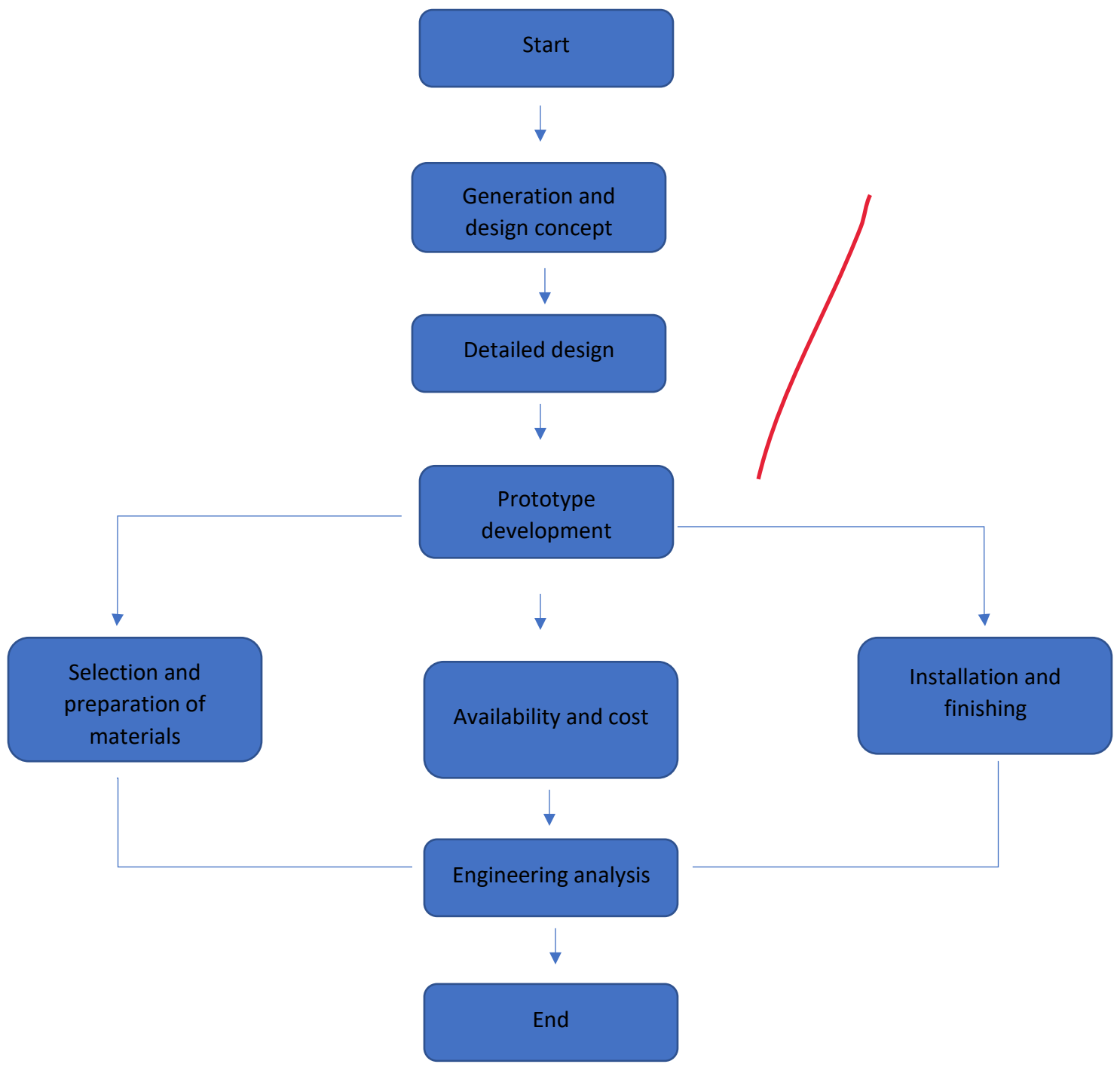

3.3 FLOW CHART EXPLANATION

3.3.1 Generation and concept selection

The generation and concept design is done after the literature review. We clarify the problem of the existing product. From the survey and advise about the fire diffuser, we got the customer needs analysis. We used the information that we gain from the survey to upgrade as we get to know what is the need and expectation of the users for the generation and concept selection.

3.3.2 Detailed design

Detailed design is done after we discussed with the group members. Give a specific size (measurement) that fully fit the fire diffuser inside the box. Beside that we also designed it in suitable shape and size to make the kitchen fire system easy to install in every kind of space and place, it also strong enough to stand all the out force pressure and in critical situation. That detailed design is designed in Auto Cad design and inventor design, at here now we have a perfect illusion to imagine the project (product) look like. With the design it can help us to solve the problem and fix it during making a prototype.

3.3.3 Prototype development

In the process of prototype development, we give a specific space to make sure the fire diffuser can function well in a long period without interruption. The prototype are build up with the selection and preparation materials, to make sure the box and the fire diffuser inside are safely place without any damage. The prototype are also build into high accurate position for the fire diffuser. Other than that, the aspect that we list down are need to apply in it so that they are fully function and show out the characteristic and functionality every part that has been selected. Double check the fire diffuser are working well and make sure all the things can be work smoothly.

3.3.4 Selection and preparation of materials

The right choice of materials is very important to produce a prototype of a automatic fire diffuser. With the good selection and preparation, we can conduct out a good result/product for the consumer and audiences. The selection must come out with the important point that can be strongly support the project use and functionality. We found out a lot of materials but the only suitable materials will going to use that can be fulfill the needs and show all the characteristics of the product. Try and repeat choosing is the best way to come out the final selection and preparation of materials. This can reduce our time and money on the unnecessary materials.

3.3.5 Availability and cost

The cost of the production process is less than RM400.00. We invested a significant amount of money in Arduino and Motor. A motor capable of creating air pressure throughout the buzzer. When the sensor detects fire, Arduino will activate a motor. It has the ability to spray. Continue doing so until the fire is completely out. Our smart phone will receive a notification by use of an application.

3.3.6 Installation and Finishing

The prototype installation will be done after the materials and equipment are gathered and also after deciding the design of the suitable box. The installation is done by referring the design of the box.

3.4 PROJECT DESIGN / SCHEMATIC CIRCUIT

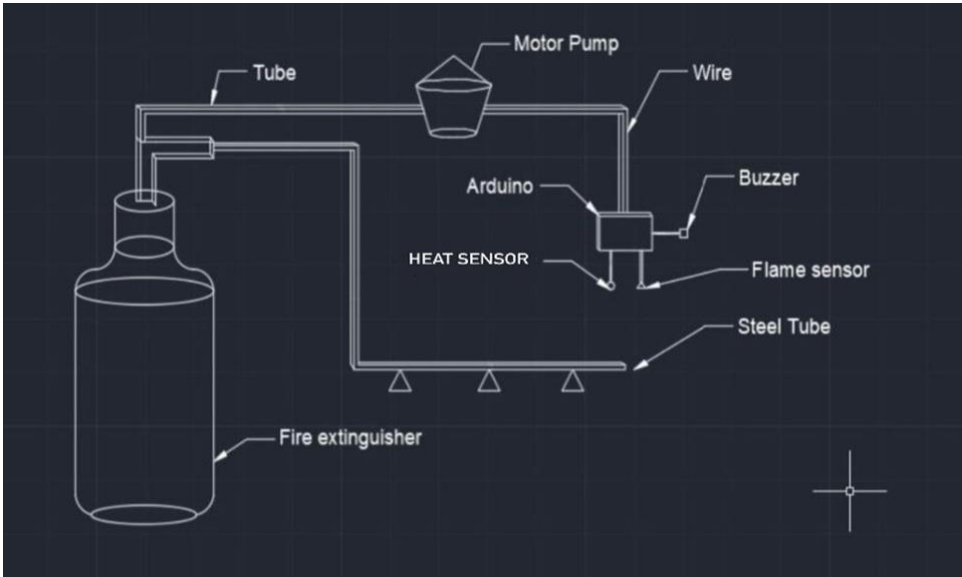

2D Drawing in schematic circuit

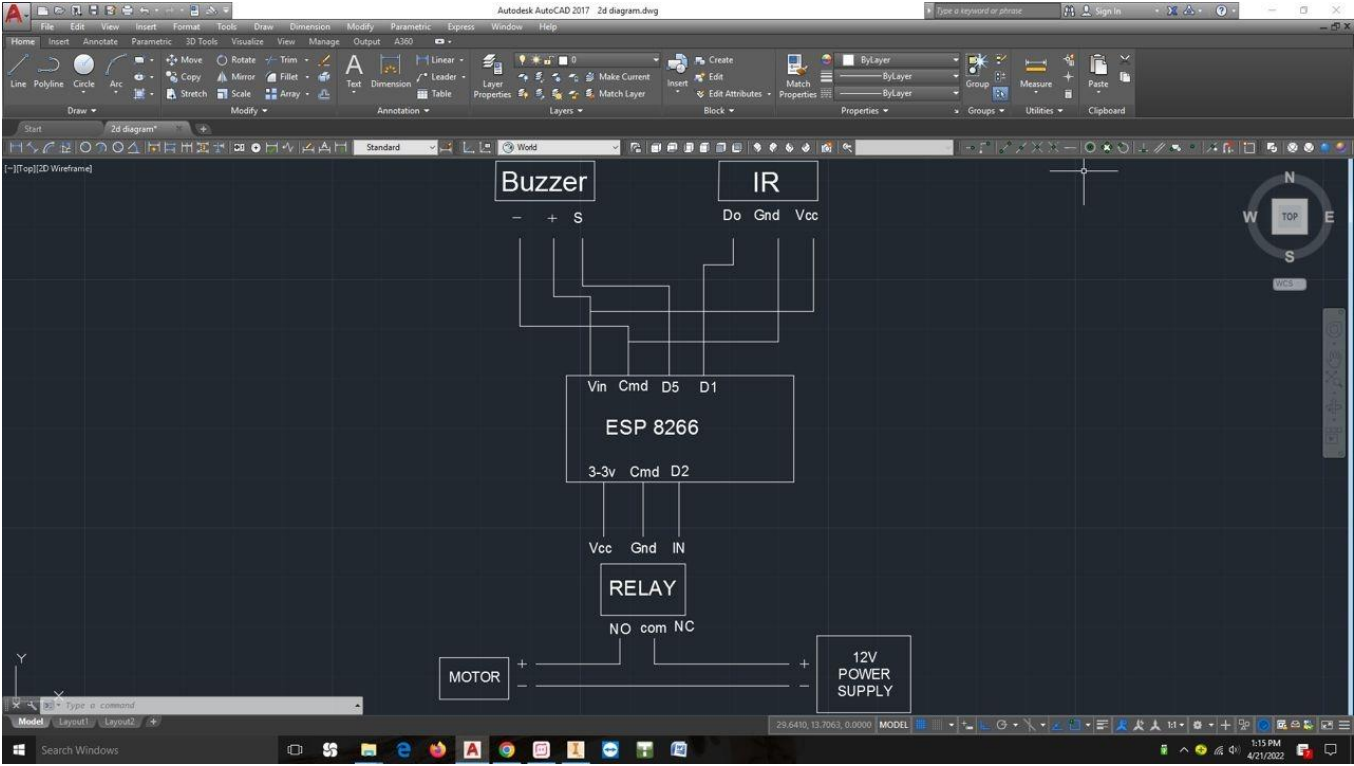

DRAWING:

i. Drawing 2d mode

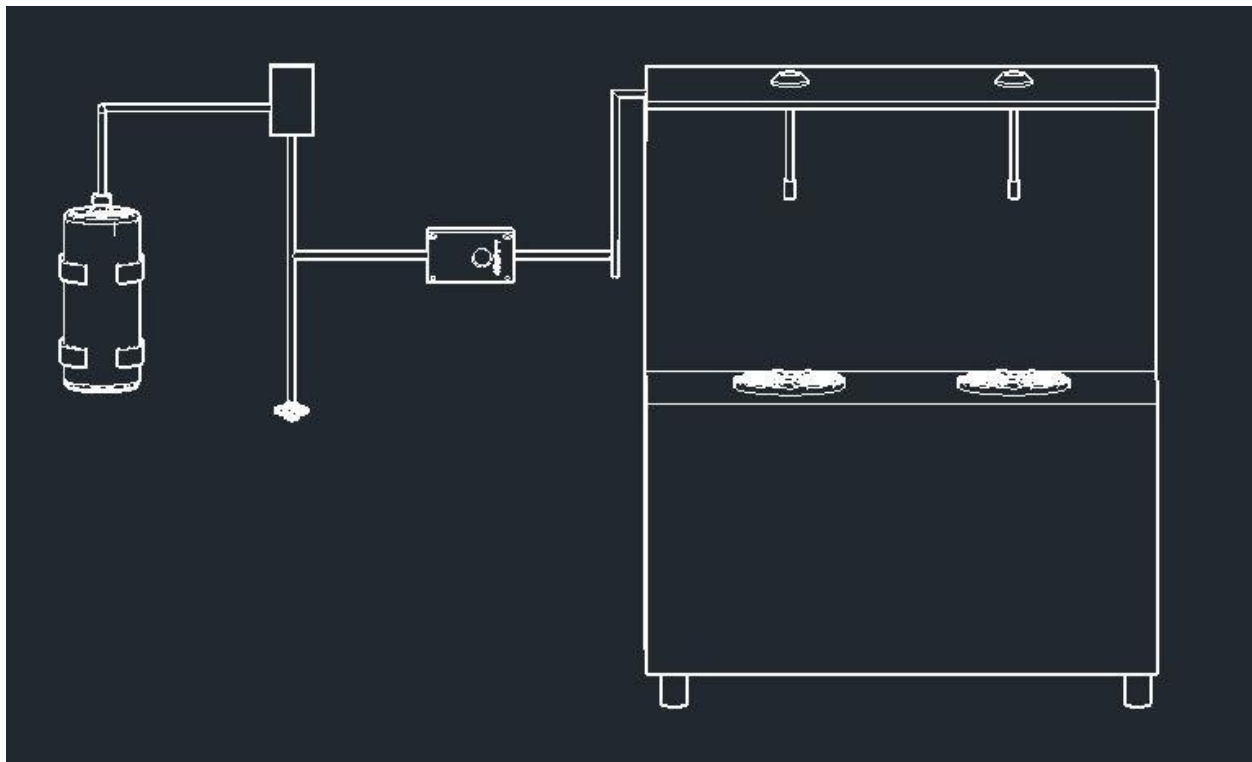
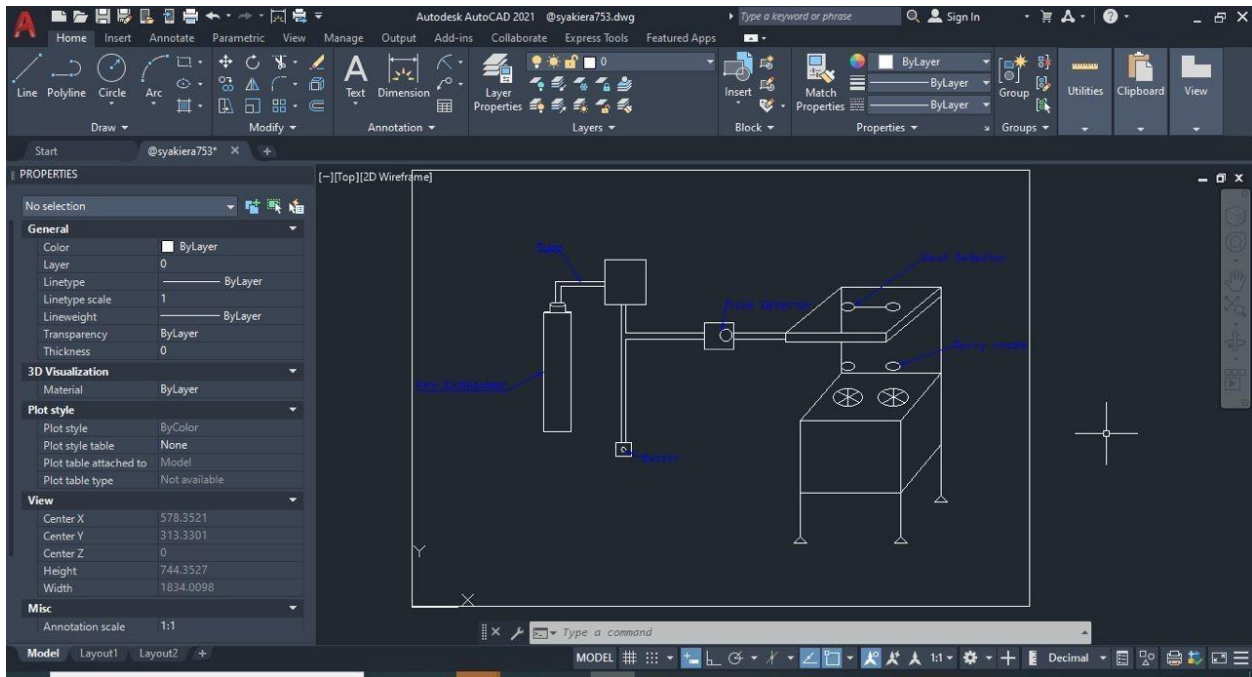

ii. Drawing 3d mode

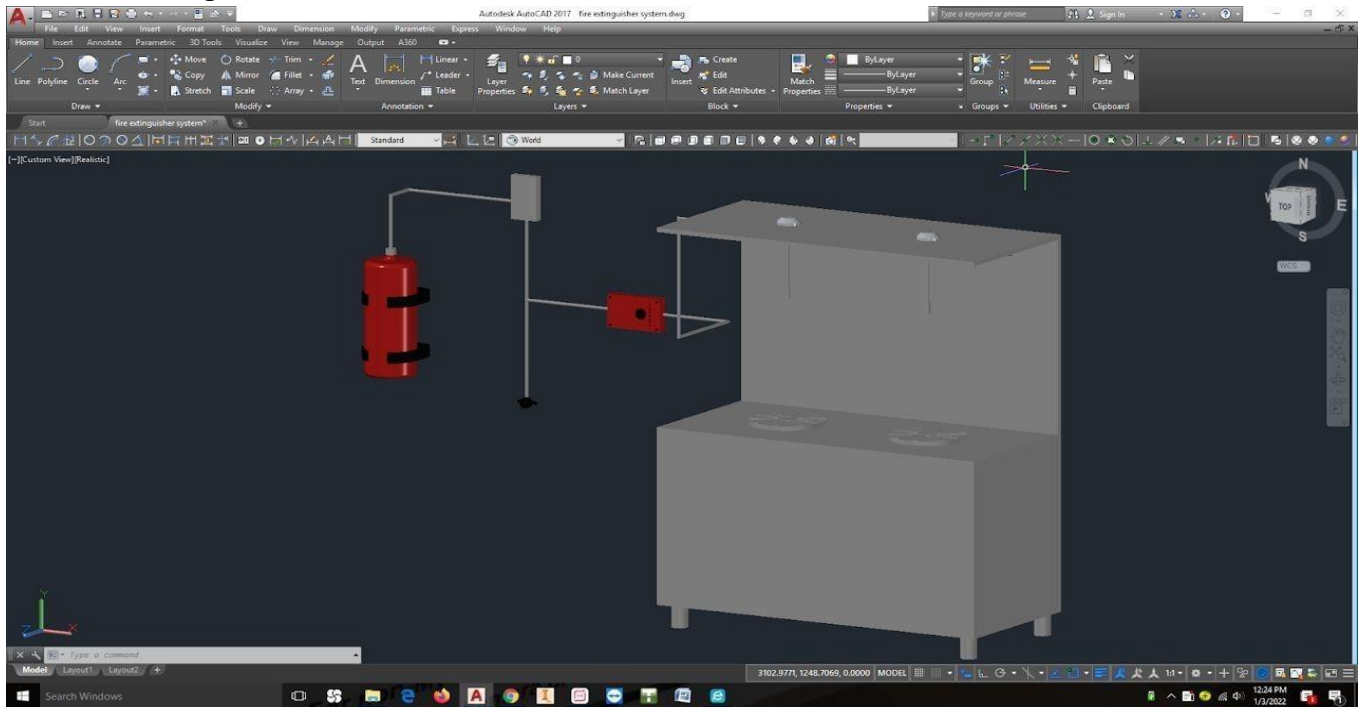

iii. All view drawing

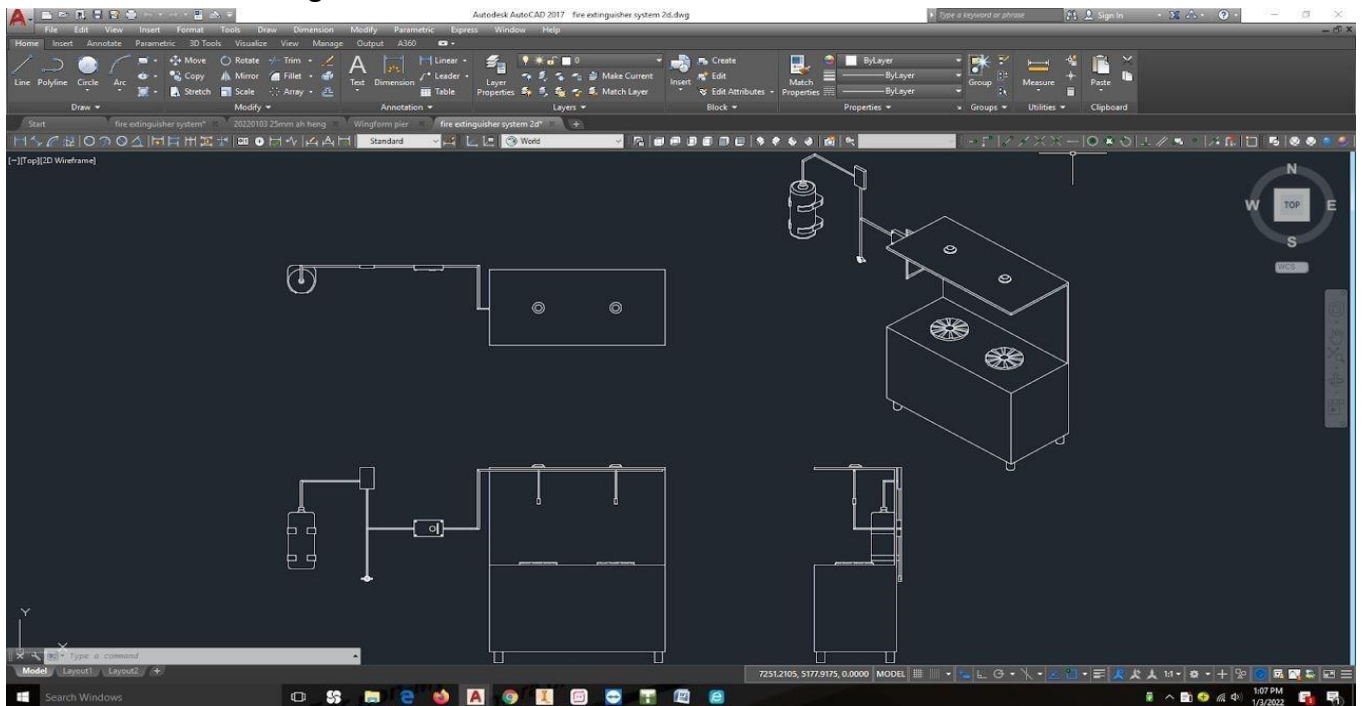

3D MODEL PROJECT OF KITCHEN FIRE SYSTEM

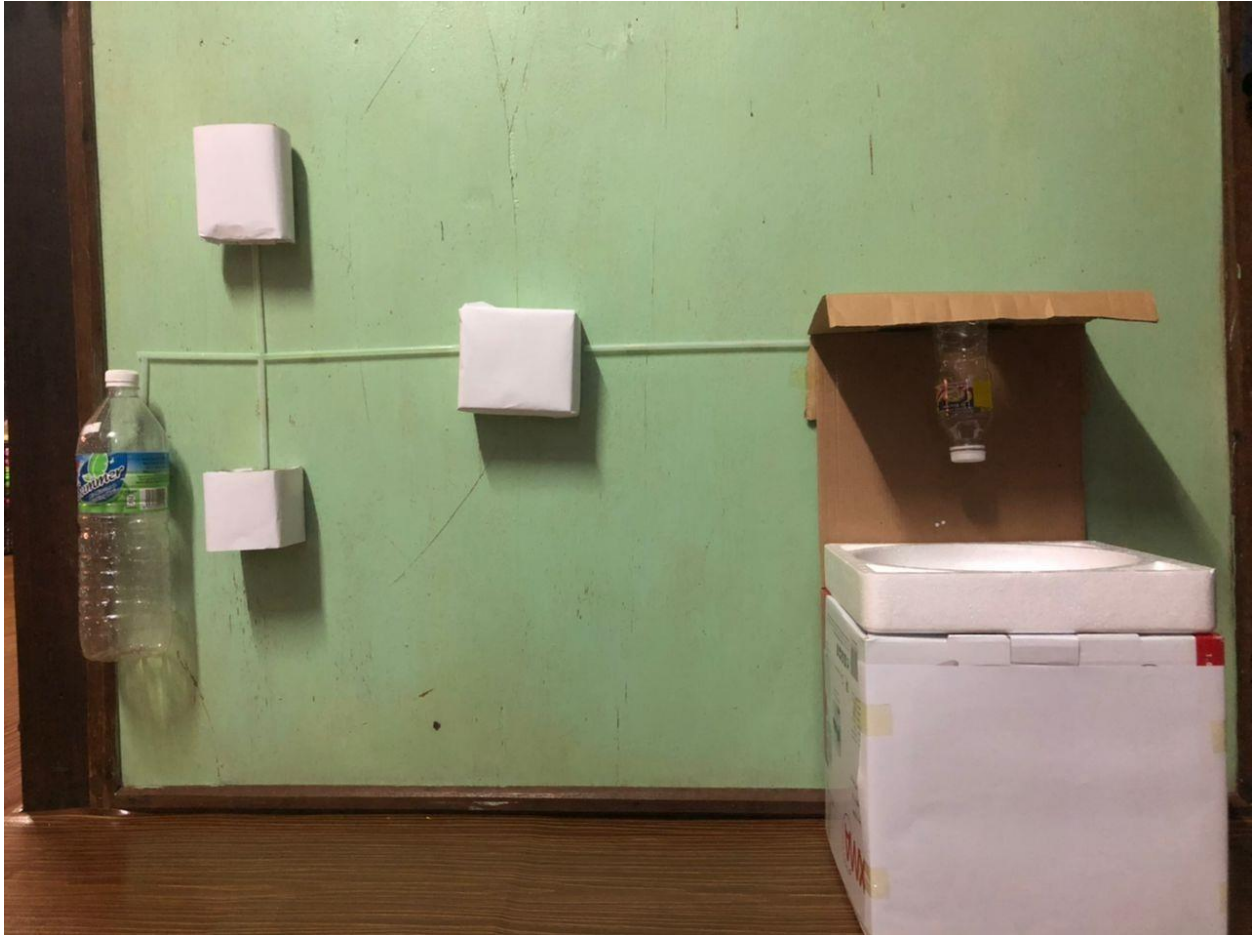

FINAL MODEL PROJECT OF KITCHEN FIRE SYSTEM

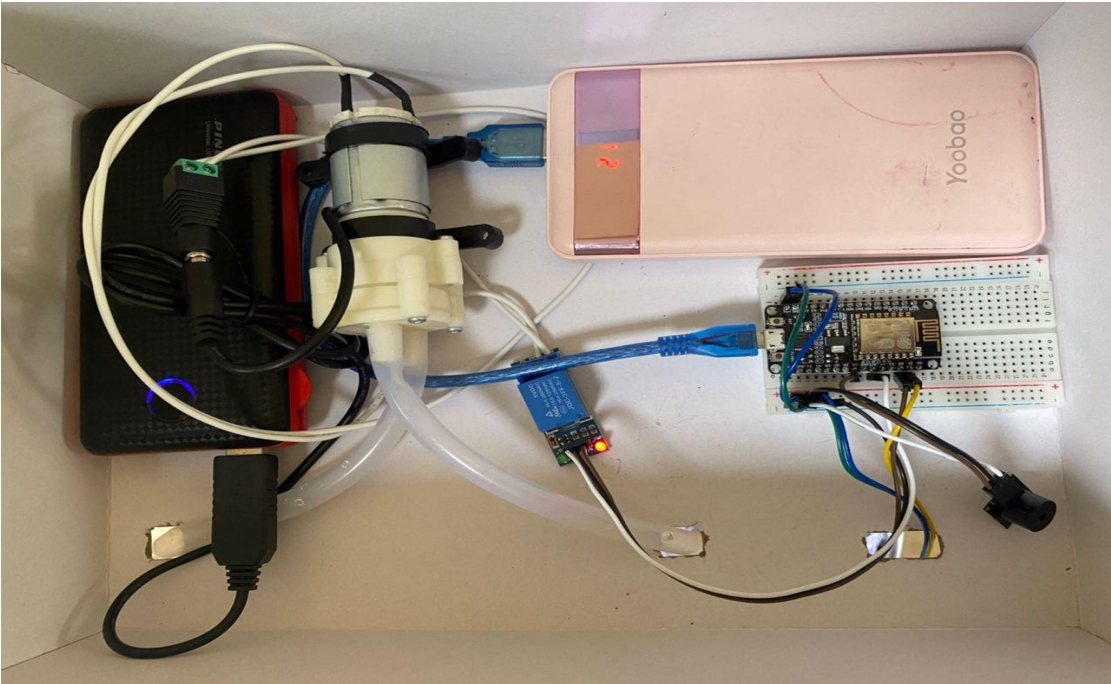

CODING

```
FireExtinguisher3600 | Arduino 1.8.19
File Edit Sketch Tools Help

FireExtinguisher3600
#define BLYNK_PRINT Serial
#include <ESP8266WiFi.h>
#include <BlynkSimpleEsp8266.h>

char auth[] = "2vJKHsnM-cPff6p9cYqx-S0zY-L4kFaiL";//Blynk
char ssid[] = "HUAWEI Y9 Prime ";
char pass[] = "kiera2001";

int fire = 5;
int relay = 4;
int buzzer = 14;
boolean Auto = false;
int con = 0;

BlynkTimer timer;

BLYNK_WRITE(V1)
{
  int pinValue = param.asInt();
  if (pinValue == 1) {
    Auto = true;
    digitalWrite(relay, LOW);
  }
  else {
    Auto = false;
    digitalWrite(buzzer, LOW);
    digitalWrite(relay, HIGH);
    con = 0;
  }
}

1 NodeMCU 1.0 (ESP-12E Module), 80 MHz, Flash, Legacy (new can return nullptr), All SSL ciphers (most compatible), 4MB (FS:2MB OTA~1019KB), 2, v2, Lower Memory, Disabled, None, Only Sketch, 115200 on COM3
Type here to search 25°C Partly cloudy 11:52 PM 6/16/2022
```

```
FireExtinguisher3600 | Arduino 1.8.19
File Edit Sketch Tools Help

FireExtinguisher3600
Auto = false;
digitalWrite(buzzer, LOW);
digitalWrite(relay, HIGH);
con = 0;
}
Serial.println(pinValue);
}

void myTimerEvent()
{
  int flame = digitalRead(fire);
  Serial.println(flame);
  if (Auto == false) {
    if (flame == 0) { //ade fire
      digitalWrite(relay, LOW); //relay on = pump on
      digitalWrite(buzzer, HIGH); //buzzer off
      Blynk.virtualWrite(V6, "Fire Detected");
      if (con == 0) {
        con = 1;
        Blynk.notify("Coution Fire Detected");
      }
    }
    else { //xde fire
      digitalWrite(relay, HIGH); //off pump
      digitalWrite(buzzer, LOW); //off buzzer
      Blynk.virtualWrite(V6, "No Fire");
      con = 0;
    }
  }
}

1 NodeMCU 1.0 (ESP-12E Module), 80 MHz, Flash, Legacy (new can return nullptr), All SSL ciphers (most compatible), 4MB (FS:2MB OTA~1019KB), 2, v2, Lower Memory, Disabled, None, Only Sketch, 115200 on COM3
Type here to search 25°C Partly cloudy 11:53 PM 6/16/2022
```

```
FireExtinguisher3600 | Arduino 1.8.19
File Edit Sketch Tools Help
FireExtinguisher3600
  Blynk.notify("Coution Fire Detected");
}
else { //xde fire
  digitalWrite(relay, HIGH); //off pump
  digitalWrite(buzzer, LOW); //off buzzer
  Blynk.virtualWrite(V6, "No Fire");
  con = 0;
}
}

void setup()
{
  Serial.begin(115200);
  pinMode(fire, INPUT);
  pinMode(relay, OUTPUT);
  pinMode(buzzer, OUTPUT);
  digitalWrite(relay, HIGH);
  Blynk.begin(auth, ssid, pass);
  timer.setInterval(1000L, myTimerEvent);
}

void loop()
{
  Blynk.run();
  timer.run(); // Initiates BlynkTimer
}

1 NodeMCU 1.0 (ESP-12E Module), 80 MHz, Flash, Legacy (new can return nullptr), All SSL ciphers (most compatible), 4MB (FS:2MB OTA~1019KB), 2, v2 Lower Memory, Disabled, None, Only Sketch, 115200 on COM3
Type here to search 25°C Partly cloudy 11:53 PM 6/16/2022
```

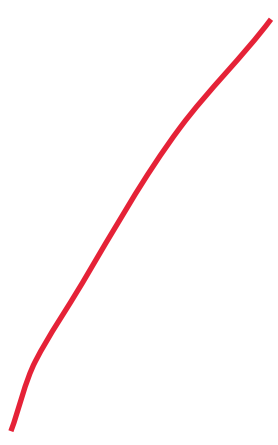

3.5 COMPONENTS

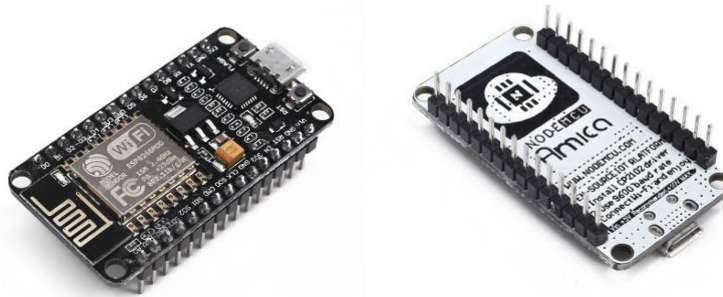

NODEMCU Lua IoT I2C ESP8266 Wifi Controller Board ESP-12 CP2102 For Arduino

NodeMCU is the fastest leading edge low cost technologies to WiFi enabled IoT. Modern high-level mature LUA based technology. It is an integrated unit with all available resources on board. It is super simple to complement your existing Arduino projects or any development board that has I/O pins available. Modern Internet development tools such as Node.js can take advantage the NodeMCU with the built-in API to put your idea on the fast track immediately. NodeMCU is built based on the mature ESP8266 technology to take advantage the abundant resources available on the web. NodeMCU has ESP-12 based serial WiFi integrated on board to provide GPIO, PWM, ADC, I2C and 1-WIRE resources at your finger tips. NodeMCU has built-in CP2102 USB to TTL Converter Module with superior stability



Female To Female Arduino Breadboard Dupont Jumper Wires

"Jumper wire" redirects here. For wire bridges, see jumper. For fly-wires, see enameled wire. For patch leads, see patch cable. A jump wire (also known as jumper, jumper wire, DuPont wire) is an electrical wire, or group of them in a cable, with a connector or pin at each end (or sometimes without them – simply "tinned"), which is normally used to interconnect the components of a breadboard or other prototype or test circuit, internally or with other equipment or components, without soldering. Individual jump wires are fitted by inserting their "end connectors" into the slots provided in a breadboard, the header connector of a circuit board, or a piece of test equipment.

A jumper is a conductor that is rated to carry full line (load plus capacitive charging) current and is installed to connect line spans on opposite sides of a deadend or a large angle structure. The jumper is installed on each phase of the line and operates at full line voltage. Interrupting a jumper loop consists of disconnecting at least one end of each jumper from the line conductors after the electrical load of the line has been reduced to zero, but the line remains energized. This is done to isolate a section of a line, for example, a span between the station entrance structure and the disconnect switch in the substation. Often, longer line sections must also be separated.



R385 DC 12V Pneumatic Diaphragm Water Pump Motor 6W

R385 6-12V DC Diaphragm Based Mini Aquarium Water Pump is an ideal non submersible pump for variety of liquid movement application. It has enough pressure to be used with nozzle to make spray system. The pump can handle heated liquids up to a temperature of 80°C and when suitably powered can suck water through the tube from up to 2m and pump water vertically for up to 3m. Possible uses/projects include; a small aquarium pump, automatic plant watering system, making a water feature or music activated dancing water features to name but a few. When pumping a liquid the pump runs very quietly. The pump is also capable of pumping air, though when pumping air the pump is quite noisy in comparison.

The R385 requires between 6 – 12V DC and between 0.5 – 0.7A and will deliver its maximum operating values when power is at the upper end of these ranges. This immersible pump can be used to water your plants, make a fountain or waterfall, and even change your fish tank water. It works quietly with the sound level under 30db. The pump has a filter inside as well as a suction cup which can help stick it to smooth surfaces tightly.



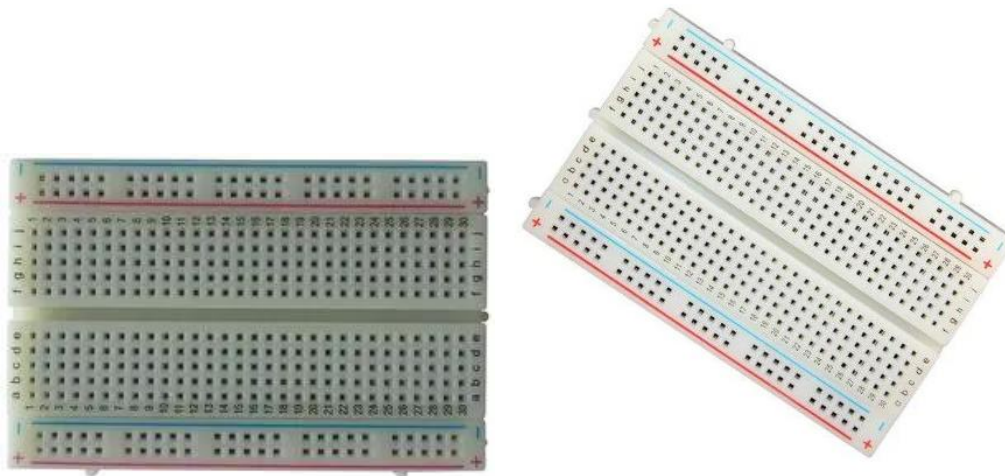

MB102 400 Points Mini Breadboard Solderless

Solderless circuit boards are excellent ways of testing designs for appliances and circuits. They do not require many tools or solder so you can use a solderless circuit board over and over again. Solderless circuit boards work well in a laboratory or classroom setting.

Function

Solderless circuit boards are used for prototyping and designing applications. The circuit board allows electronic components to be made into circuits throughout the boards without the use of tools, solder or any permanent changes to the circuit board. Do not mess with the circuits while the circuit board is powered, as you will risk bodily harm or harming the circuit board. Because the solderless breadboard does not require soldering, it is reusable. This makes it easy to use for creating temporary prototypes and experimenting with circuit design. For this reason, solderless breadboards are also popular with students and in technological education. Older breadboard types did not have this property.

A stripboard (Veroboard) and similar prototyping printed circuit boards, which are used to build semi-permanent soldered prototypes or one-offs, cannot easily be reused. A variety of electronic systems may be prototyped by using breadboards, from small analog and digital circuits to complete central processing units (CPUs).



Flame Sensor 3 Pin Fire Detection IR Receiver Module Arduino PIC

A flame detector is a sensor designed to detect and respond to the presence of a flame or fire. Responses to a detected flame depend on the installation but can include sounding an alarm, deactivating a fuel line (such as a propane or a natural gas line), and activating a fire suppression system. The IR Flame sensor used in this project is shown below, these sensors are also called Fire sensor module or flame detector sensor sometimes.

There are different types of flame detection methods. Some of them are: Ultraviolet detector, near IR array detector, infrared (IR) detector, Infrared thermal cameras, UV/IR detector etc. When fire burns it emits a small amount of Infra-red light, this light will be received by the Photodiode (IR receiver) on the sensor module. Then we use an Op-Amp to check for a change in voltage across the IR Receiver, so that if a fire is detected the output pin (DO) will give 0V(LOW), and if there is no fire the output pin will be 5V(HIGH).

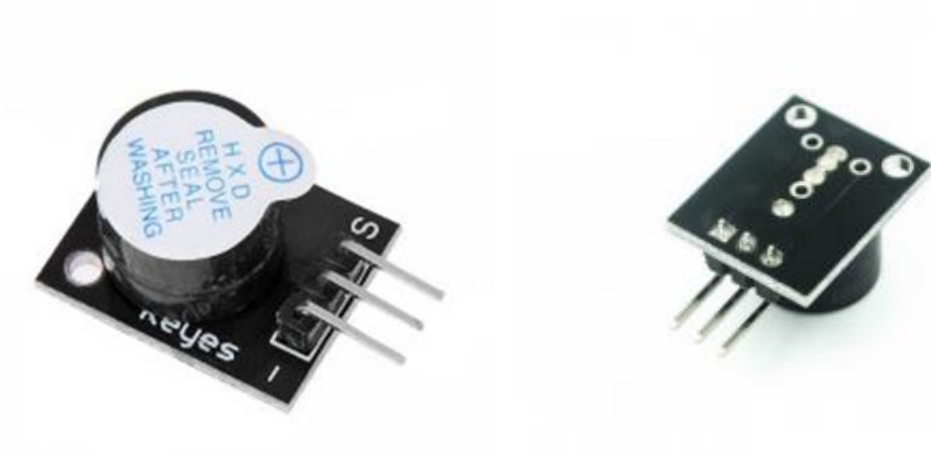

KY-012 Active Buzzer Module

The KY-012 active piezo buzzer is a 3-pin module that creates an audible sound at 2.5 kHz without the need for pulse width modulation (PWM) or any additional complex code. The only requirement is to set the signal pin to HIGH. If you're looking for a simple but effective way to build audio into an Electronics or Arduino project, the KY-012 Active Buzzer Module is a great choice, and is designed to simply produce a single-tone sound when the incoming signal is high. This allows for single-pin operation on an Arduino Board, which is perfect for building a custom alarm or detection system that can send out an audible signal when it receives the electronic high signal from the Arduino controller board.



ESP8266 Wifi Module

The ESP8266 is a low-cost Wi-fi microchip, with a full TCP/IP stack and IC capability, produced by Espressif Systems in Shanghai, China.

The chip first came to the attention of Western makers in August 2014 with the ESP-01 module, made by a third-party manufacturer Ai-Thinker. This small module allows microcontrollers to connect to a Wi-Fi network and make simple TCP/IP connections using Hayes-style commands.

However, at first, there was almost no English-language documentation on the chip and the commands it accepted. The very low price and the fact that there were very few external components on the module, which suggested that it could eventually be very inexpensive in volume, attracted many hackers to explore the module, the chip, and the software on it, as well as to translate the Chinese documentation.

The ESP8285 is an ESP8266 with 1 MiB of built-in flash, allowing the building of single-chip devices capable of connecting to Wi-Fi.



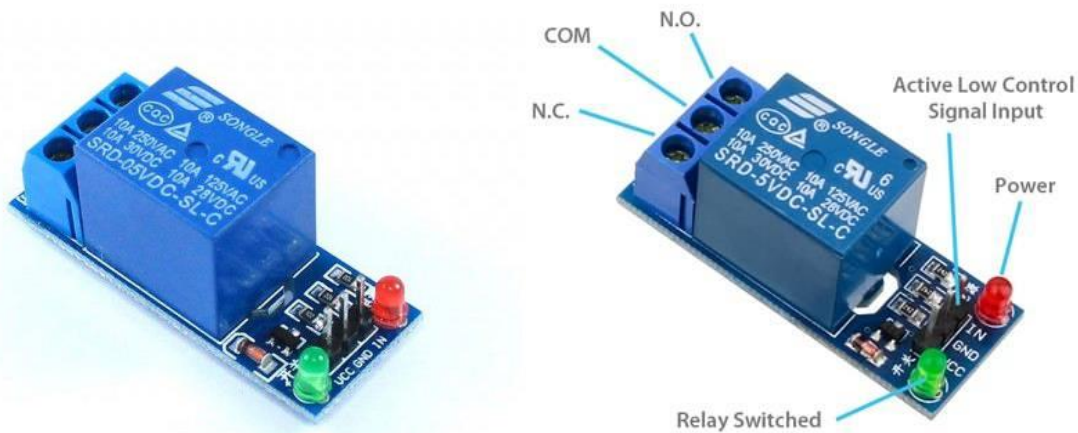

SINGLE CHANNEL 5V RELAY MODULE

The Single Channel Relay Module is a convenient board which can be used to control high voltage, high current load such as motor, solenoid valves, lamps and AC load. It is designed to interface with microcontroller such as Arduino, PIC and etc. The relays terminal (COM, NO and NC) is being brought out with screw terminal. It also comes with a LED to indicate the status of relay. A 5v relay is an automatic [switch](#) that is commonly used in an automatic control circuit and to control a high-current using a low-current signal. The input voltage of the relay signal ranges from 0 to 5V.

The Relay breakout board is a convenient board to be used with 5V microcontrollers such as SK40C, SK28A, [Arduino](#), SKds40A, SK18B. You can easily use 5V signal to control the relay. Three inputs:

- VCC = 5V is needed
- GND = Common Ground, 0V
- IN = Control signal need to be 5V 0V to activate the Relay (Active Low)

The relay terminals (COM, NO, and NC) are brought out using a 3-way screw terminal. On-board relay is rated at 10A. It can be used in many applications: controlling high voltage, high current loads such as motor, solenoid valves, lamps, and AC load. It also comes with 2 LEDs to indicate the status power (VCC) and the status of the relay.

Note: This is an active-high active-low device, which means logic high (5V) low (0V) at pin IN will trigger the relay.

3.6 BUDGET CALCULATION

Mechanical parts cost:

BIL	MATERIAL	QUANTITY	PRICE/UNIT (RM)	TOTAL (RM)
1	BOX	1	RM10	RM10
2	POWERBANK : 10000mAh	2	RM70	RM140
			OVERALL TOTAL =	RM150.00

System cost:

BIL	MATERIAL	QUANTITY	PRICE/UNIT (RM)	TOTAL (RM)
1	ESP8266 WIFI	1	RM19.50	RM19.50
2	JUMPER WIRE	1	RM3.10	RM3.10
3	R385 D12V METER TUBE	1	RM3.50	RM3.50
4	R385 D12V PUMP	1	RM11.70	RM11.70
5	SOLDERLESS	1	RM2.40	RM2.40
6	ARDUINO	1	RM2.60	RM2.60
7	BUZZER MODULE	1	RM2.50	RM2.50
8	SINGLE 5V RELAY	1	RM10.00	RM10.00
9	USB POWER BOOST LINE : 12V	1	RM20.00	RM20.00
10	MICRO USB	1	RM15.00	RM15.00
			OVERALL TOTAL =	RM90.30

Overall total cost : Rm 240.30

3.7 PROJECT ACTIVITY

GANTT CHART PLANNING FOR FINAL YEAR PROJECT 1

TASK/WEEK	1	2	3	4	5	6	7	8	9	10	11	12	13	14
FIND FINAL PROJECT TOPIC	█	█	█	█	█	█								
MEETING WITH SUPERVISOR	█	█	█	█	█	█	█	█	█	█	█	█	█	█
STUDY OBJECTIVE OF PROJECT							█	█						
SEARCH PROJECT INTRODUCTION							█	█						
SEARCH PROBLEM STATEMENT							█	█						
SEARCH PROJECT SCOPE&LIMITATION							█	█						
SEARCH LITERATURE REVIEW							█	█						
SEARCH METHODOLOGY									█	█				
MAKING FLOW CHART									█	█				
MAKING LAYOUT DRAWING PROJECT IN AUTOCAD											█	█		
MAKING TABLE WEEK PLANING											█	█		
MAKE QUESTINNAIRE													█	
COMPLETE OUR PROPOSAL													█	
SUBMIT PROPOSAL & REPORT														█
SUBMIT LOGBOOK														█

GANTT CHART PLANNING FOR FINAL YEAR PROJECT 2

WEEK/ PROJECT ACTIVITY	WE EK	7/3	14/3	21/3	28/3	4/4	11/4	18/4	25/4	9/5	16/5	23/5	30/5	6/6	13/6
Briefing to resume the final project 2 report	P														
	A														
Briefing about how to calculate project 2 marks	P														
	A														
Planning and comparing project materials	P														
	A														
Study and make revision about the project	P														
	A														
Write a project report and update individual logbook	P														
	A														
Make additional searches in literature review, methodology	P														
	A														
Make abstract and poster development	P														
	A														
	P														

Attach each component to function	A														
Component material testing	P														
	A														
Making video report	P														
	A														
Make project improvement	P														
	A														
Complete project and testing	P														
	A														
Present the results of the final project to the supervisor	A														
Submission of final project result to the supervisor	A														

Instruction

-  Planning
-  Actual



3.8 Summary

To summarise, the strategies used in this project are quite vital in completing the job. The literature evaluation, idea development, and concept selection are all done systematically in the methodological study in order to know the facts and information needed to support the research instrument and describe it more clearly in this study.



CHAPTER 4

FINDINGS AND ANALYSIS

4.1 INTRODUCTION

This chapter discusses our project's findings and analysis. After gathering all of the data and information, an analysis is performed to determine the success of the Development of Kitchen Fire System installation. The data presented in this chapter are based on surveys and experiments conducted in the research region. Data from experiments in the research area is evaluated in more depth in order to develop conclusions based on the specified study objectives.

This data and analysis are critical to the project's success in meeting its objectives and scope. This information suggests that the materials testing was successful. After gathering all of this information, we examine every detail in order to make it ideal.

4.2 GENERAL VIEW OF STUDY

Whether the fire extinguisher is an early fire prevention device from the fire continues to spread ?

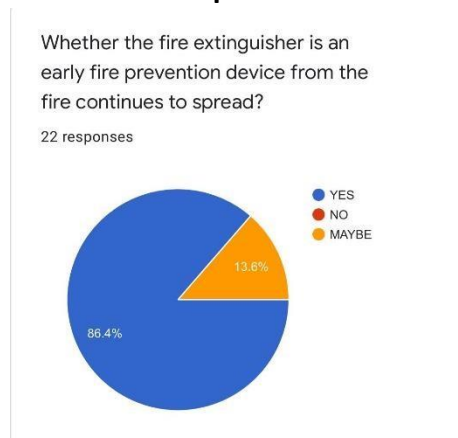

Diagram 4.1.1

Diagram 4.1.1 shows the analysis obtained based on the question stated above. From the analysis about 86.4% of the respondent agrees that fire extinguisher is an early fire prevention device. Meanwhile, the remaining 13.6% of the respondent feels it might be an early prevention. No negative response is obtained.

Does your home/office have a kitchen fire system ?

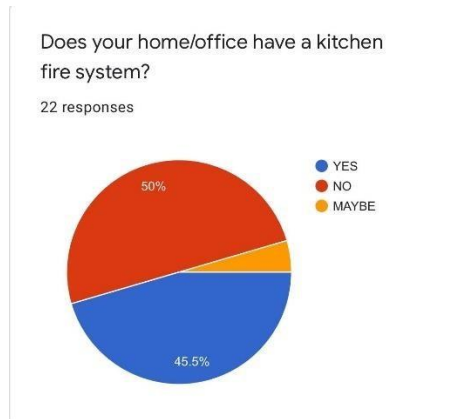

Diagram 4.1.2

Diagram 4.1.2 shows the analysis 50% of the respondent don't have kitchen fire system. Meanwhile 45.5% have kitchen fire system at home/office.

Does a manually controlled kitchen fire system make it easy for you ?

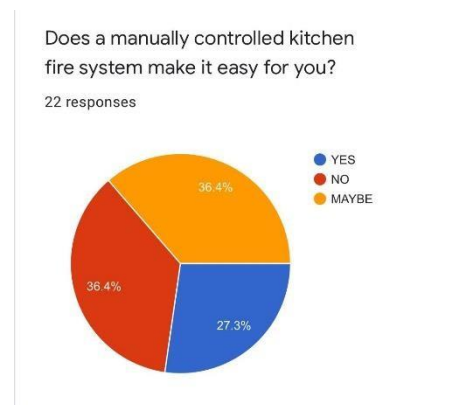

Diagram 4.1.3

The result of the analysis from the diagram 4.1.3 shows that a the average indicates respondents agree and disagree are equal which is 36.4% . Meanwhile 27.3% respondent say maybe manually controlled kitchen fire system make it easy to them.

Do you think the size of the existing kitchen fire system is right for you ?

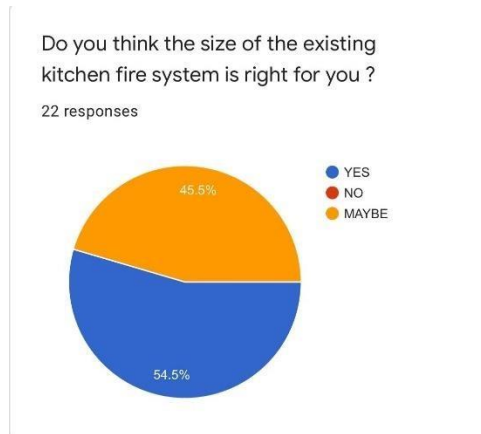

Diagram 4.1.4

Diagram 4.1.4 shows the result of the analysis regarding the size of the extinguisher, whereby 54.5% of the respondent agree that the size of the existing fire extinguisher is right for them. 45.5% of respondent feels maybe the sizes is right for them.

Will you buy a kitchen fire system that will work automatically ?

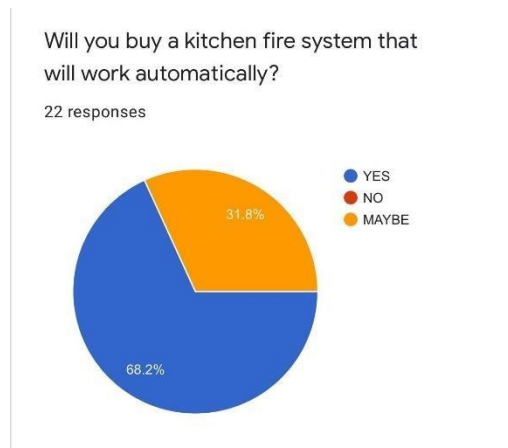

Diagram 4.1.5

The following analysis is about the acceptance of respondent about the kitchen fire system. The result in the diagram shows that 68.2% of the respondent accepts the kitchen fire system that will work automatically. Besides that, 31.8% respondent maybe accepts.

Do you think it is worth it to buy this kitchen fire system ?

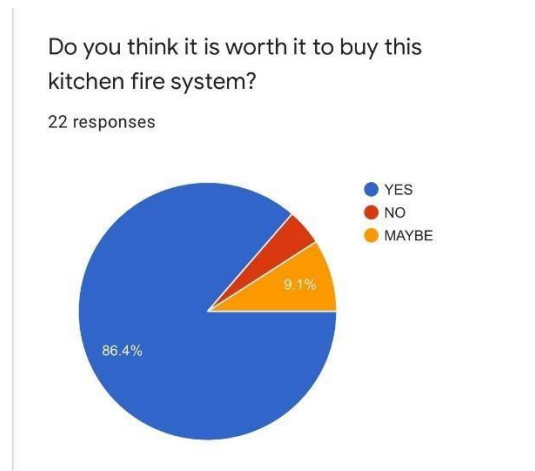

Diagram 4.1.6

Diagram 4.1.6 shows the analysis that does the respondent feels it is worth to buy kitchen fire system. About 86.4% respondent feels it is worth, 9.1% feels it might be worth it.

4.3 ADVANTAGE AND DISADVANTAGE

Every project has its own advantages and disadvantages. However, the the disadvantages must be improvised or changes needed to be applied so that we could enhance the good and very efficient product that hardly to find disadvantage of the project. Kitchen Fire System has a lot of advantages to help people to put out fire in time and prevent huge damages from happening.

4.4 CHAPTER SUMMARY

As a conclusion for this chapter , the analysis and findings have been made. This Kitchen Fire System has a lot of advantages however there are every cons to pros. Hence, the challenges are taken as a room for improvements and more developments for future generation and well as to enhance their knowledge on the project we carried out

CONCLUSION

The conclusion is the design and implementation of the Kitchen Fire System is adaptable and flexible based on our project. This wireless detection technique is more costeffective than the typical market's current fire detection devices. This Kitchen Fire System detection framework has a high precision rate and responds quickly to changes in temperature and stickiness levels, enabling constant integration with customers and providing more secure protection. All upgrades will be performed in order for this project to provide additional benefits and advantages. Last but not least, I hope that this initiative will continue to grow in scope for future generations.

NO Tech.
data:]

REFERENCES

1. <https://www.reactonfire.com/what-we-protect/residential-kitchens/>
2. <https://www.quora.com/What-are-the-characteristics-of-a-fire-extinguisher>
3. <https://www.squareone.ca/resource-centres/home-personal-safety/fireextinguisher-guide-for-your-home>
4. <https://www.zurithsafety.com.my/post/types-advantages-and-disadvantages-offire-extinguishers>
5. <https://www.youtube.com/watch?v=9jse9l-tknk>
6. <http://my.chinesefire.net/news/historical-background-of-fire-extinguishers15137852.html>
7. <https://amsl.ie/2021/11/01/4-reasons-to-have-a-fire-safety-system-in-yourkitchen/>
8. https://www.researchgate.net/publication/315756890_A_Study_on_Fire_Safety_and_Security_at_Kitchen_in_Apartment_Buildings
9. BSI (2004) PD 7974-6 The application of fire safety engineering principles to fire safety design of buildings. Human factors: Life safety strategies. Occupant evacuation, behaviour and condition. British Standards Institute, London.
10. Department For Communities And Local Government Publications (2006), Fire Safety Risk Assessment : Residential Care Premises.
11. U.S. Fire Administration. (2008). Cooking Fire Safety.
12. Black, B.D. (2002) Life safety, fire protection, and mobility-impaired persons. In: Fire Protection Engineering 16, p. 26-29.
13. Cornwell, B. (2003) Bonded Fatalities: Relational and Ecological Dimensions of a Fire Evacuation. In: The Sociological Quarterly 44, p. 617-638.
14. Fire Journal: Protection, Prevention & Suppression, September, pp. 24-25.