



**POLITEKNIK SULTAN SALAHUDDIN ABDUL  
AZIZ SHAH**

**AUTOMATIC CAT LITTER BOX (ACLB)**

<b>NURUL SYUHADA BINTI MUHAMAD SHUKOR</b>	<b>08DKM19F1077</b>
<b>MIA SYAFIQA AFIRA BINTI MARZUKI</b>	<b>08DKM19F1100</b>
<b>MUHAMMAD FIRDAUS BIN RAIHAN</b>	<b>08DKM19F1093</b>

**JABATAN KEJURUTERAAN MEKANIKAL**

**SESI 1 : 2021/2022**

**POLITEKNIK SULTAN SALAHUDDIN ABDUL  
AZIZ SHAH**

**AUTOMATIC CAT LITTER BOX (ACLB)**

**NURUL SYUHADA BINTI MUHAMAD SHUKOR                      08DKM19F1077**

**MIA SYAFIQA AFIRA BINTI MARZUKI                              08DKM19F1100**

**MUHAMMAD FIRDAUS BIN RAIHAN                                 08DKM19F1093**

**Laporan ini dikemukakan kepada Jabatan Kejuruteraan Mekanikal sebagai  
memenuhi sebahagian syarat penganugerahan Diploma Kejuruteraan  
Mekanikal (Pembungkusan)**

**JABATAN KEJURUTERAAN MEKANIKAL**

**SESI 1 : 2021/2022**

## AKUAN KEASLIAN DAN HAK MILIK

### AUTOMATIC CAT LITTER BOX (ACLB)

1. Kami, **NURUL SYUHADA BINTI MUHAMAD SHUKOR (NO KP: 010421-10-1432)**, **MIA SYAFIQA AFIRA BINTI MARZUKI (NO KP: 010504-07-0694)**, **MUHAMMAD FIRDAUS BIN RAIHAN (NO KP: 010703-10-0999)** adalah pelajar Diploma Kejuruteraan Mekanikal, Politeknik Sultan Salahuddin Abdul Aziz Shah, yang beralamat di **Persiaran Usahawan, Seksyen U1, 40150 Shah Alam, Selangor**. (Selepas ini dirujuk sebagai 'Politeknik tersebut').
2. Saya mengakui bahawa Automatic Cat Litter Box dan harta intelek yang ada di dalamnya adalah hasil karya/ reka cipta asli saya tanpa mengambil atau meniru mana-mana harta intelek daripada pihak-pihak lain.
3. Saya bersetuju melepaskan pemilikan harta intelek Automatic Cat Litter Box kepada Politeknik Sultan Salahuddin Abdul Aziz Shah bagi memenuhi keperluan untuk penganugerahan **Diploma Kejuruteraan Mekanikal** kepada saya.

Diperbuat dan dengan sebenar-benarnya diakui

oleh yang tersebut;

NURUL SYUHADA BINTI MUHAMAD SHUKOR

(No. Kad Pengenalan: 010421-10-1432)

)

) .....

) NURUL SYUHADA

MIA SYAFIQA AFIRA BINTI MARZUKI

(No. Kad Pengenalan: 010504-07-0694)

)

) .....

) MIA SYAFIQA

MUHAMMAD FIRDAUS BIN RAIHAN

(No. Kad Pengenalan: 010703-10-0999)

)

) .....

) MUHAMMAD FIRDAUS

Di hadapan saya,

AHMAD FAKARUDDIN BIN MOHD FAUZI

(No. Kad Pengenalan: 821127-08-6189)

)

) .....

sebagai Penyelia Projek pada tarikh: 10/03/2021

) AHMAD FAKARUDDIN

## **ACKNOWLEDGEMENT**

First and foremost, we would like to express our gratitude to Allah Almighty for the chance to complete this Final Year Project. We would also want to convey our heartfelt gratitude to Politeknik Sultan Salahuddin Abdul Aziz for providing us with the opportunity to complete our Diploma in Mechanical Engineering courses. Following that, we'd like to show our thankfulness to various individuals who have aided us over our diploma years. Our deepest appreciation and gratitude to our supervisor, Mr. Ahmad Fakaruddin Bin Mohd Fauzi, for skilfully guiding us from scratch to completion of the report and for the time spent with us for discussion and review of the paper. His vast expertise and experience significantly assist us in completing this research. Additionally, we would like to convey our heartfelt appreciation and gratitude to our parents and family for their unwavering support, love, encouragement, and prayers, which have been a source of strength for us. Finally, we would like to express our gratitude and appreciation to all our friends for their efforts and support throughout this semester, particularly to our team members Nurul Syuhada, Mia Syafiqa, and Muhammad Firdaus. We would like to express our gratitude to everyone who assisted us in completing our Final Year Project.

## **ABSTRACT**

The idea to construct this project is by doing an observation towards products that was use in daily life. One of the products that catch our attention is cat litter box, the product has produced many types of cat litter box with different feature. However, we acknowledge that there is a slight problem with cat litter box that is used manually, which is cat owner did not have enough time to clean and dispose the faeces because of their daily works, the faeces disposing work is inefficient, and also the safety of cats during cleaning operation for other automatic cat litter box is quite hazardous. The fabrication process was done by evaluating cat owners problems and needs in handling this product. The users problems and needs was taken into account during the fabrication of this project by designing the product, create a system that can operate automatically, selecting the material of the product, testing and analysing. Several test will be construct to test the product, such as the effectiveness of the scoop to drag the faeces along the way to waste compartment, the time taken for the operation, durability and safety of cats during operation. Conclusively, purpose for this project is to save cat owner's time by designing cat litter box that can operate automatically and also to increase safety for cats during cleaning operation. One of the recommendation to improve this project is by using renewable energy such as solar as the main power for the product.

## ABSTRAK

Idea untuk menghasilkan project ini adalah dengan melakukan pemerhatian pada kehidupan seharian. Salah satu produk yang telah menarik perhatian kami adalah *cat litter box*, produk ini telah mengeluarkan pelbagai jenis *cat litter box* dengan ciri-ciri berbeza. Namun begitu, kami dapati bahawa terdapat beberapa masalah pada *cat litter box* yang digunakan secara manual, di mana pemilik kucing tidak mempunyai masa yang secukupnya untuk membuang najis kerana sibuk bekerja, pembuangan najis juga tidak efisien, dan keselamatan kucing ketika proses pembersihan bagi *automatic cat litter box* adalah agak membahayakan. Proses fabrikasi dilakukan dengan menilai masalah dan kehendak pemilik haiwan dalam menangani produk ini. Masalah dan kehendak pengguna diambil kira ketika proses fabrikasi dengan merekabentuk produk, menghasilkan sistem yang boleh beroperasi secara automatik, memilih bahan produk, ujian dan analisis. Beberapa ujian akan dilakukan pada produk seperti keberkesanan pencedok untuk mengaut najis ke tempat buangan najis, masa yang diambil untuk beroperasi, ketahanan dan keselamatan kucing ketika proses pembersihan. Kesimpulannya, tujuan projek ini dibina adalah untuk menjimatkan masa pemilik kucing dengan merekabentuk *cat litter box* yang boleh beroperasi secara automatik dan juga boleh meningkatkan keselamatan kucing ketika proses pembersihan. Salah satu cadangan untuk membaik pulih project ini adalah dengan menggunakan tenaga boleh diperbaharui seperti solar sebagai sumber elektrik utama.

## LIST OF CONTENT

<b>ACKNOWLEDGEMENT</b> .....	I
<b>ABSTRACT</b> .....	II
<b>ABSTRAK</b> .....	III
<b>LIST OF TABLE</b> .....	V
<b>LIST OF FIGURE</b> .....	VI
<b>CHAPTER 1 INTRODUCTION</b> .....	1
1.1 INTRODUCTION.....	1
1.2 PROBLEM STATEMENT.....	1
1.3 PROJECT OBJECTIVE.....	2
1.4 PROJECT SCOPE.....	2
1.5 SUMMARY.....	2
<b>CHAPTER 2 LITERATURE REVIEW</b> .....	3
2.1 INTRODUCTION.....	3
2.2 PREVIOUS RESEARCH.....	3
2.2.1 Products in Market.....	4
2.3 COMPONENTS.....	8
2.3.1 Solar.....	8
2.3.2 Arduino.....	11
2.3.3 Mechanism.....	14
2.4 SUMMARY.....	18
<b>CHAPTER 3 METHODOLOGY</b> .....	19
3.1 INTRODUCTION.....	19
3.2 PROJECT DESIGN.....	20
3.2.1 Method/Procedure.....	21
3.2.2 Product Specification.....	23
3.2.3 Material Selection.....	23
3.2.4 Fabrication.....	24
3.2.5 Materials and Tools.....	27
3.2.6 Data Analysis Method.....	32
3.3 SUMMARY.....	32
<b>CHAPTER 4 FINDING AND ANALYSIS</b> .....	33
4.1 INTRODUCTION.....	33
4.2 FINDINGS DATA.....	33
4.3 TEST RESULTS.....	35
4.4 ADVANTAGES.....	38
4.5 SUMMARY.....	39
<b>CHAPTER 5 RECOMMENDATION</b> .....	40
5.1 INTRODUCTION.....	40
5.2 CONCLUSION.....	40
5.3 RECOMMENDATIONS.....	41
5.4 LIMITATIONS.....	41
5.5 SUMMARY.....	41
<b>REFERENCES</b> .....	42
<b>ATTACHMENT</b> .....	43

## LIST OF TABLE

<b>TABLE NO.</b>	<b>TITLE</b>	<b>PAGE</b>
2.1	Criteria comparison	7
2.2	Different Types of Arduino	13
2.3	AC and DC Motor Comparison	16
2.4	DC Motor and Stepper Motor Comparison	17
3.1	Materials & Tools Cost	27
4.1	Data Taken from Test	38



## LIST OF FIGURE

FIG. NO.	TITLE	PAGE
2.1	Evolution of Cat Litter Box	4
2.2	Cat Litter Box 1	5
2.3	Cat Litter Box 2	5
2.4	Cat Litter Box 3	6
2.5	The First Solar Panel created by Charles Fritz	9
2.6	Solar Power Conversion Process	10
2.7	Arduino Uno	11
2.8	Arduino Uno Circuit	12
2.9	Four Bar Link	15
2.10	Slider Crank	15
2.11	Spur Gear	15
2.12	Bevel Gear	15
2.13	Stepper Motor	17
3.1	Flow Chart	20
3.2	First Concept Design	21
3.3	Second Concept Design	22
3.4	Third Concept Design	22
3.5	Cat Litter Box Drawing Specification	23
3.6	Corrugated Board	24
3.7	Electrical Parts Assembly	24
3.8	Base cutting Process	25
3.9	PVC Pipe cutting and attaching Process	25
3.10	Platform Fabrication Process	25
3.11	Scoop and Waste Compartment Fabrication	26
3.12	Body Cover Fabrication	26
3.13	Final Product	26
3.14	Arduino Uno	27
3.15	Arduino NodeMCU ESP 32	28

3.16	Breadboard	29
3.17	Jumper Wire	29
3.18	Stepper Motor	29
3.19	Charging Board	30
3.20	Voltage Regulator	30
3.21	Soldering Iron	31
3.22	Soldering Wire	31
4.1	How Frequent Cat Owner has to clean Litter Box	34
4.2	Data of People Who Agree and Disagree about the use of Cat Litter Box	34
4.3	Percentage of People who Agree with IOT	35
4.4	Weight of the Waste and Scoop	36
4.5	Distance between each Rod	37
4.6	Cat Litter Type 1	37
4.7	Cat Litter Type 2	38
6.1	Gantt Chart	43
6.2	3D Drawing View	44
6.3	Assembly Part	44

# **CHAPTER 1 INTRODUCTION**

## **1.1 INTRODUCTION**

In this modern world, evolution of technology is not a queer things to society anymore. Technology started to develop through out the days around the world to thrive along in this modern era. People start to create and design things to have a better performance, efficiency and to help society overcome their problems. In this proposal, we decided to create a new cat litter box with different and new features from the previous cat litter box that is in market. We wanted to make differences from the previous design especially by adding green sustainability concept.

## **1.2 PROBLEM STATEMENT**

Cat lovers comes in all ages and occupation and they usually have to go to school, work or overseas. This matter might be a problem to all cat owner because cat litter box need to be clean everyday for people who own one to two cat per house. They did not have enough time to clean their cat's waste for they have a tight schedule.

Automatic cat litter box that was already in the market also has a feature that the scoop can move automatically. However, it is quiet inconvenience because the scoop operate automatically without the supervision of cat owner and this can lead to cat's body parts being stuck in the product.

### **1.3 PROJECT OBJECTIVE**

For this final year project, we are going to make a new automatic cat litter box with extra new feature that might solve problem and upgrade the previous automatic cat litter box. Our main objectives are:

- i. Designing a cat litter box that can operates automatically.
- ii. To help users save their time to dispose cat's waste everyday.
- iii. To ensure cat's safety during cleaning operation.

### **1.4 PROJECT SCOPE**

For our product, we have set a limitations on the operation to ensure that our product can fully achieve the objectives. The scopes are:

- i. This product is only suitable for one to two cats only.
- ii. Battery need to be used as main power for product to operate.

### **1.5 SUMMARY**

Chapter 1 consist of 4 elements, which is introduction, problem statement, project objective and project scope. To summarize, current market cat litter box does not use much of advanced technology and can be troublesome to cat owners. In order to embark with the Fourth Industrial Revolution (IR 4.0) and as encourage by Ministry of International Trade and Industry (MITI), the product that will be made will highlight green sustainability.

## **CHAPTER 2 LITERATURE REVIEW**

### **2.1 INTRODUCTION**

There are many types of cat litter box in the market, the most common cat litter box sold in market is the manual one which we need to scoop the waste by ourselves. This cat litter box can be found in most pet store. However, nowadays technology changed through out the time and function on cat litter box was added and changes are made mostly on the design and mechanism.

In this project that we were about to do, we have have done some research on cat litter box in the market to help us design our product and add new function to it to have better performance that previous product did not have. One of the product that we refer to do this project is PetSafe, this product has produce many cat litter box and market it in pet store. PetSafe is the very first brand that launched an automatic cat litter box with ScoopFree as the first model to be in the market. By referring this product, we tried to design our own cat litter box with our very own idea.

### **2.2 PREVIOUS RESEARCH**

There are many types of cat litter box in market with different design and functions. It started manually, then through time and technology development, it started to change bit by bit. Cat litter box started to evolve to ease and simplify cat owners life which an automatic performance is added to fulfill user needs. Figure 2.1 below show how cat litter box was changed through the time.



**Figure 2.1:** Evolution of Cat Litter Box

### **2.2.1 Products in Market**

Various types of cat litter box is marketed in the market that has different design and usage. Each of the design has their very own design specification to fulfill customers needs. However each of the product has their own advantages and disadvantages.

In early of the production, the design of the product is very simple which is it is only has the shape of rectangle as in the figure 2.2 below. It works manually which we need to dispose the waste by our hand with a scoop. This product is very simple and also much cheaper than other products. However the only things that does not fulfill customer needs is that users needs to constantly clean the waste and that problem has cost lots of time consuming.



**Figure 2.2:** Cat Litter Box 1

Next evolution of cat litter box is that it has an automatic disposing system. The scoop moves on their own to dispose the waste and also some of the product has timer as in the figure 2.3 below. This litter box is fully operated by it's own with no scooping or refilling required, the product uses disposable replacement litter trays with a plastic lining that creates an extra barrier to prevent leakage. Safety sensors detect when cats are using the litter box and resets the rake timer accordingly. There is also and health counter that allows owners to track how frequently their cat is using the litter box to determine when it is time to change the litter. Additionally, it can help owners detect early warning signs of health issues, such as a urinary tract infection, if their cat's usage changes.



**Figure 2.3:** Cat Litter Box 2




The newest design of the product is that it has a feature to dispose the waste automatically as in figure 2.4 below. This feature allows the product to dispose waste in toilet bowl automatically, so that users did not have to take out the waste from the waste compartment and dispose it in bin. This feature did not only saves users time, but it is also can guarantee the healthy of the uses because it lessen the users contact with the waste. Somehow some people found out there is flaws in this product which it needs to be place in the toilet right next to the toilet bowl.



**Figure 2.4:** Cat Litter Box 3



**Table 2.1: Criteria Comparison**

Picture	Criteria	Design	Method
 <p>Cat Litter box 2</p>	<ul style="list-style-type: none"> <li>➤ Scoop moves on a straight line.</li> <li>➤ Cat's waste is disposed into waste compartment.</li> </ul>	<p>Rectangle</p>	<p>Automatic</p>
 <p>Cat Litter Box 3</p>	<ul style="list-style-type: none"> <li>➤ Platform moves in circular motion.</li> <li>➤ Cat's waste is disposed into toilet bowl.</li> </ul>	<p>Round</p>	<p>Automatic</p>
 <p>Cat Litter Box 4</p>	<ul style="list-style-type: none"> <li>➤ Scoop is fixed in a place.</li> <li>➤ Platform moves in circular motion.</li> <li>➤ Cat's waste is disposed into waste compartment.</li> </ul>	<p>Round</p>	<p>Automatic</p>

## 2.3 COMPONENTS

In this literature review, we have also done some research on important components that we wanted to include in our project. This can guide us on how to apply in the product for it to work completely and efficiently. Without this components the product will have difficulty to work properly.

### 2.3.1 Solar

(MIA SYAFIQA AFIRA BINTI MARZUKI)

Solar energy is really nothing new as people have been using alternative energy as far back in history because the 7th century B.C [1]. The earliest uses of alternative energy included focusing the sun's energy through a light microscope to begin fires for cooking [2]. Sunrooms were invented in the earlier period to capture solar power for its natural warmth. One legend in the Greek solar history is when Archimedes setting fire to besieging wooden ships from the great empire [2]. It happened when he reflected the sun's light energy off bronze shields, concentrating the rays and attacking the enemy before they even made a landfall [1].

Think of it as a form of beam of sunlight. But this experiment in solar energy was tested by the Greek navy within the 1970s. They tried to set fire to a wooden test ship 50 meters away using nothing but the legendary bronze shield and also the solar light energy and succeed [1].

Edmond Becquerel, a French physicist find out about the photovoltaic effect while experimenting with a cell made from metal electrodes in a very conducting solution in 1839. He found out that the cell produced more electricity when it was directly exposed to light [1]. Later in 1873, Willoughby Smith discovered that selenium could function as a photoconductor. The next three years, in 1876 William Grylls Adams and Richard Evans Day appealed the photovoltaic principle discovered by Becquerel to selenium [3]. They recorded that it could, in fact, generate electricity when it is exposed to light [2].

Almost 50 years after the photovoltaic effect's discovery, in 1883, finally Charles Fritz an American inventor successfully created the primary working selenium electric cell, though we use silicon in cells for contemporary solar panels, this photovoltaic cell was a significant precursor to the technology used today [3]. In a way, many physicists played a huge part in the discovery and invention of photovoltaic cell. Becquerel mainly attributed with uncovering the potential of the photovoltaic effect, and Fritz with actually creating and realizing the ancestor to all or any solar cells [1].



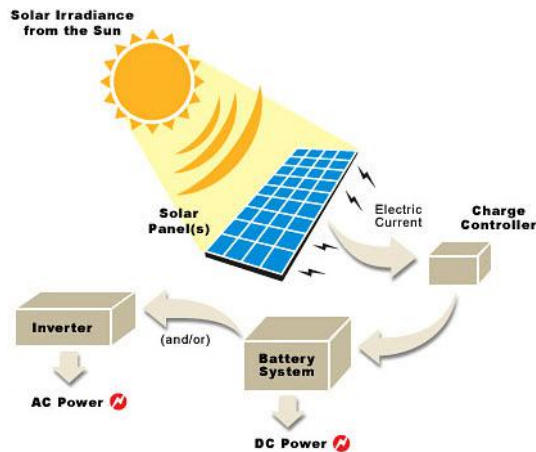
**Figure 2.5 :** The first solar panel created by Charles Fritz (Source: [www.goingsolar.com.au](http://www.goingsolar.com.au))

How does solar panel works?

Photovoltaic solar panels generate direct current (DC) electricity. By using DC electricity, electrons flow in one direction around a circuit and the example of this electricity is such as when a battery powering a light bulb. Then, the electrons move from the negative side of the battery, through the lamp, and return to the positive side of the battery [4].

In the flow of alternating current (AC) electricity, the electrons are pushed and pulled and periodically reversing direction, it is much like the cylinder of a car's engine. Generators normally creates AC electricity when a coil of wire is spun next to a magnet. Plenty of alternative energy sources can "turn the handle" of this generator such as gas hydroelectricity, nuclear, coal, wind or diesel [5].

AC electricity was chosen for the U.S. electrical power grid, primarily because one of its advantages is it is less expensive to transmit over long distances. However, solar panels create DC electricity so it needs an inverter to get DC electricity into the AC grid [4].



**Figure 2.6 :** Solar Power Conversion Process (Source: [www.elprocus.com](http://www.elprocus.com))

These solar panels have lots of uses as it is in everyday things like calculator, watches and flashlights. There are also solar-powered toys, radios and MP3 players. There are solar-powered cell phones and pager by using solar power with devices like these means you never have to worry about batteries. Solar panels are sometimes used to produce the electricity to light up road signs and bus stops [6].

How long do solar panels last?

As a general rule, solar panels could last for about 25-30 years. Nevertheless, this does not mean that they stop producing electricity after reaching the 25 years mark, it just means that energy production has declined by what manufacturers consider to be a significant amount [7]. As stated by Mark Robards, one of the directors for ECS Refining said that the longevity of these panels are determine by the way they are put together and how they were made. Solar panels will continue to work for many decades, given they are not physically damaged by wind, debris, or any other external factors. This is primarily because this photovoltaic panel do not have any moving parts and they rarely break from within. They are commonly only damaged by outside forces like a poor racking setup or inclement weather [7].

### 2.3.2 Arduino

(MUHAMMAD FIRDAUS BIN RAIHAN)



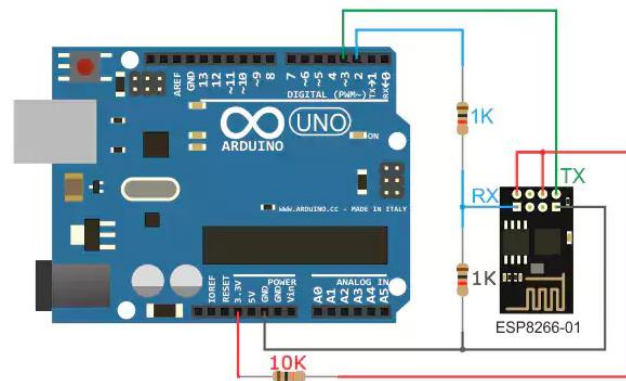
**Figure 2.7:** Arduino Uno

Arduino is an open-source electronics platform that uses simple hardware and software to make it easy to use. Arduino boards can detect inputs - such as light on a sensor or a finger on a button - and convert them to outputs - such as turning on an LED, triggering a motor, or posting anything online. By providing a set of instructions to the board's microcontroller, you may tell it what to do. The Arduino programming language (based on Wiring) and the Arduino Software (IDE) (based on Processing) are used to accomplish this. Thousands of projects have used Arduino throughout the years, ranging from simple household items to complicated scientific apparatus. This open-source platform has united a global community of makers - students, amateurs, artists, programmers, and professionals - whose contributions have added up to an enormous quantity of accessible knowledge that may be of tremendous benefit to novices and specialists alike. [1]

Arduino was created at the Ivrea Interaction Design Institute as a simple tool for rapid prototyping intended for students with no previous experience with electronics or programming. As soon as it attracted a larger audience, the Arduino board began to evolve in order to meet new requirements and problems, evolving from simple 8-bit boards to solutions for IoT, wearables, and 3D printing, and embedded settings. All Arduino boards are open-source, allowing users to create them on their own and customize them to meet their own needs [2].

For physical computing, there are a variety of additional microcontrollers and microcontroller platforms to choose from. Similar functionality can be found in Parallax Basic Stamp, Netmedia's BX-24, Phidgets, MIT's Handy board, and many other software. All of these software condenses the complicated elements of microcontroller programming into an easy-to-use package. Arduino also makes dealing with microcontrollers a lot easier [1].

How does Arduino works?



**Figure 2.8:** Arduino Uno Circuit

The Arduino is a microcontroller board based on the ATMEL AVR. Microcontrollers are integrated circuits that can store instructions written in the Arduino IDE environment's programming language. These instructions let you write programs that interact with the board's circuitry. Because of their simplicity, the Atmega168, Atmega328, Atmega1280, and ATmega8 are the most commonly used microcontrollers on Arduino platforms, although it is being expanded to include Atmel microcontrollers with 32-bit ARM architecture as well as Intel microcontrollers [3].

The Arduino microcontroller contains communication and input/output ports, which can be used to connect various peripherals to the board. The information from the peripherals you connect will be sent to the microcontroller, which will be in charge of processing the data. Arduino, on the other hand, offers us with software that includes an IDE that implements the Arduino programming language, tools for transferring firmware to the microcontroller, and a bootloader that runs on the board. The software's and programming language's key features are their simplicity and ease of use [3].

The Arduino board has such a wide range of capabilities that it may be used to create almost anything. Different modules, such as obstacle sensors, presence detectors, fire sensors, GSM modules, GPS modules, and so on, can be readily coupled to this board. Because the Arduino board functions as a tool, its primary job is to control electronics by reading inputs and converting them to outputs. This board can also be used to create many electronics projects in the fields of electronics, electrical engineering, robotics, and so on. [4]

#### Features of Different Types of Arduino Board

**Table 2.2:** Different Types Of Arduino Boards (Source: <https://www.elprocus.com/different-types-of-arduino-boards/>)

<b>Arduino Board</b>	<b>Processor</b>	<b>Memory</b>	<b>Digital I/O</b>	<b>Analogue I/O</b>
<b>Arduino Uno</b>	16Mhz ATmega328	2KB SRAM, 32KB flash	14	6 input, 0 output
<b>Arduino Due</b>	84MHz AT91SAM3X8E	96KB SRAM, 512KB flash	54	12 input, 2 output
<b>Arduino Mega</b>	16MHz ATmega2560	8KB SRAM, 256KB flash	54	16 input, 0 output
<b>Arduino Leonardo</b>	16MHz ATmega32u4	2.5KB SRAM, 32KB flash	20	12 input, 0 output

[1] <https://www.arduino.cc/en/guide/introduction>

[2] [https://www.researchgate.net/publication/297734853\\_Arduino\\_and\\_Open\\_Source\\_Computer\\_Hardware\\_and\\_Software](https://www.researchgate.net/publication/297734853_Arduino_and_Open_Source_Computer_Hardware_and_Software)

[3] <https://www.circuitschools.com/what-is-arduino-how-it-works-and-what-you-can-do-with-arduino/>

[4] <https://www.elprocus.com/different-types-of-arduino-boards/>

### 2.3.3 Mechanism

(NURUL SYUHADA BINTI MUHAMAD SHUKOR)

Mechanism is a device to transfer power and movement according to our desire. Mechanism can make rigid things moves when it is connected to the source of power to transfer force and motion[1](<https://www.cs.cmu.edu/~rapidproto/mechanisms/chpt2.html>). It converts input motion and force to output motion and force. Mechanism is all around us without we acknowledge it, for instance train engine, car engine, factories machine and many more. Mechanism has various of types with various of use, such as linkage, gear, cams, follower and so on.

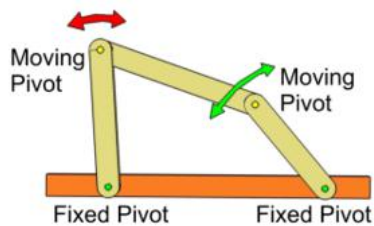
From the Greek Mathematician Archimedes to the Renaissance era, mechanism were considered to be built as a combination of the six simplest form of mechanism. Rigid body (links) and kinematic pairs (joints), the connections between body was considered by Franz Reuleaux. No link flexing nor vibration is considered form simplifying assumption of a rigid body. Kinematic pairs (joints) are also considered ideal. Then, joints was divided into lower pairs (surface contact) and higher pairs (line contact) by Reuleaux. Reuleaux defined a mechanism as “a combination of resistant bodies so arranged that by their means the mechanical force of nature can be compelled to do work accompanied by certain determinate motion”[2](<https://www.ohio.edu/mechanical-faculty/williams/html/PDF/HistoryOfMechanisms.pdf>).

Without mechanical engineer such as Archimedes, Leonardo da Vinci, James Watt, Hero of Alexandria and many more, we might no have the technology we have developed nowadays. They are the main contributor on how we can have modern technologies and more advanced mechanism. Also, they are the reason the main mechanism existed such as linkages, gears, cam followers and motor. This types of mechanism creates different work of mechanism with different functions and uses which is used in industries and our daily life.

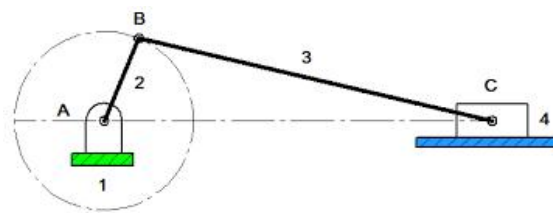


What are the main types of mechanism?

Linkages is one of the common mechanism used, links (bar) connected to two or more other links by pin joints (hinges), sliding joints, or ball-and-socket joints to form a closed chain or a series of closed chains. One of the link is going to be fixed in a place, the movement of other links relative to the fixed link and to another one will depend on the number of link connected to one another and types of joint[3](<https://www.britannica.com/technology/linkage-machine-component>).

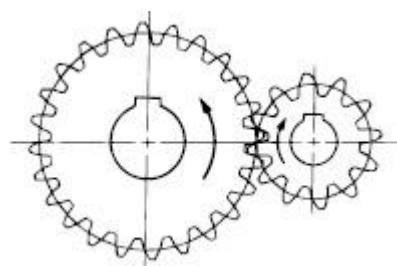


**Figure 2.9:** Four bar link

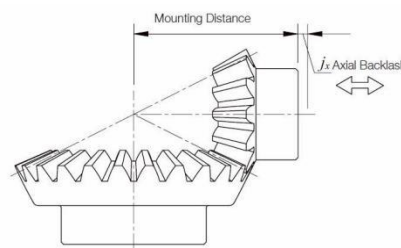


**Figure 2.10:** Slider crank

Next is gear mechanism, it has the round shape has toothed wheel attached to a rotating shaft. Gears need to be connected to each other to transmit and modify rotary motion and torque (turning force) without slip, the teeth of one gear engaging the teeth on a mating gear. Most gears are circular to transmit motion smoothly and with a nonvarying speed ratio at every instant[4](<https://www.britannica.com/technology/gear>). There are many types of gear. For example, spur gear, helical gears, rack and pinion, bevel gears and many more.



**Figure 2.11:** Spur gear



**Figure 2.12:** Bevel gear

In this product we are going to use electric motor for the work product. Motor is a device used to convert electrical energy into mechanical energy. Operating through the interaction of magnetic field and current carrying conductors to generate force is mostly how electric motor work. Two types of motor is AC motor and DC motor. The AC motor takes alternating current as an input, while the DC motor takes direct current[5](<https://circuitglobe.com/electric-motor.html>).

In AC motor, stator and rotor are the two most important parts. The rotor is the rotating part of the motor meanwhile stator is the stationary part of the motor. Single phase AC motors are commonly used for smaller power conversion. It is also mostly applied in electrical product such as refrigerator, hair dryer, washing machine, etc.

The DC motor is the most commonly used actuator for producing continuous movement and whose speed of rotation can easily be controlled. A DC motor is also the same as AC motor which consist two parts, a stator which is the stationary part and the rotor is the rotating part. There are three types of DC motor;

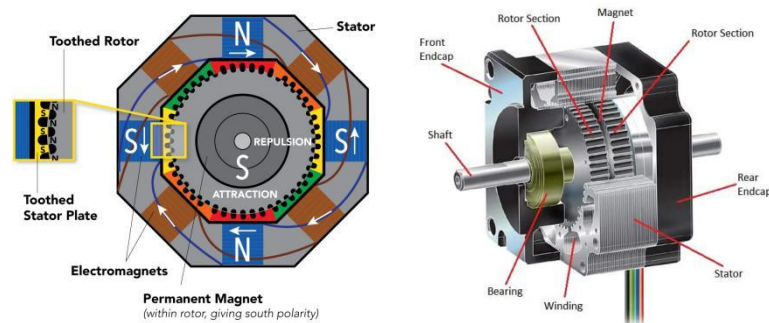
- i. Brushed motor.
- ii. Brushless motor.
- iii. Servo motor.

**Table 2.3: AC and DC Motor Comparison**

AC Motor	DC Motor
<ul style="list-style-type: none"> <li>➤ Powered from AC current.</li> <li>➤ Can be single phase or three phase.</li> <li>➤ Does not use brush.</li> <li>➤ Have a longer life span.</li> </ul>	<ul style="list-style-type: none"> <li>➤ Powered from DC current.</li> <li>➤ All DC motor are single phase.</li> <li>➤ Use brushes.</li> <li>➤ Does not have a longer life span.</li> </ul>

We are going to use a stepper motor for the mechanism. A stepper motor is a brushless DC electric motor that can change full rotation of rotor into number of equal steps. The rotor position can be controlled and positioned accurately if the motor were connected to certain application. Stepper motor use the magnetic operation to make the motor shaft turn at a precise angle when provided with electricity. The electromagnets are energized by an external driver circuit or a micro controller. The gear's teeth will magnetically attracted to one of the electromagnet and make the motor shaft turn. Next turn will happen when the previous electromagnet is turned off and a new electromagnet is turned on, the gear will rotates slightly to align with the next one [6](<https://www.elprocus.com/stepper-motor-types-advantages-applications/>).

Stepper motor is mostly suitable to use with computer controlled systems because it was digitally controlled using an input pulse. It is very useful in the industries, because it is capable to do work at certain command such as printers, factories machines, textile machine and many more. Stepper motor has three different types which is permanent magnet, variable reluctance and hybrid synchronous stepper.



**Figure 2.13:** Stepper Motor

**Table 2.4:** DC Motor and Stepper Motor Comparison

DC Motor	Stepper Motor
<ul style="list-style-type: none"> <li>➤ Operates in closed loop.</li> <li>➤ Contains brushes.</li> <li>➤ Cannot be controlled easily.</li> </ul>	<ul style="list-style-type: none"> <li>➤ Operates in open loop.</li> <li>➤ Brushless.</li> <li>➤ Can easily be controlled.</li> </ul>

## **2.4 SUMMARY**

From this chapter we learn that literature review is very important. All of the research we have done help us with the process of finding previous criteria of the product and combine it with our idea. This research also help us generate new idea and improve our product design and features. Overall from literature review, we find that our process of finding ideas were very systematic and it help the process going swiftly with the project planning.

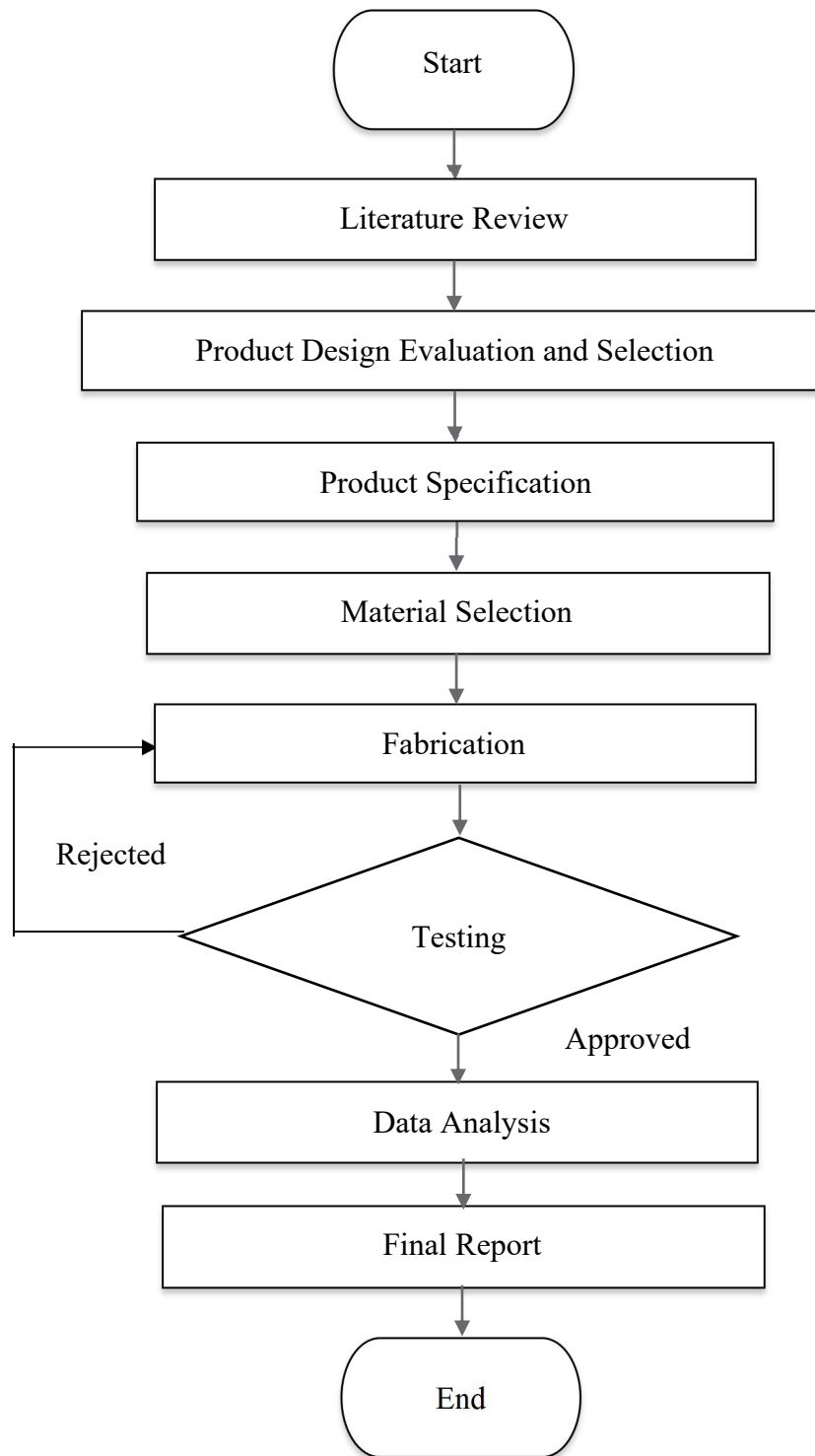
## **CHAPTER 3 METHODOLOGY**

(NURUL SYUHADA BINTI MUHAMAD SHUKOR)

### **3.1 INTRODUCTION**

The main purpose of methodology is to show the process of making the product. This chapter consist of starting from details about the product design, materials and tools, techniques that used to build the product and innovation that can be done from previous product that currently in the market.

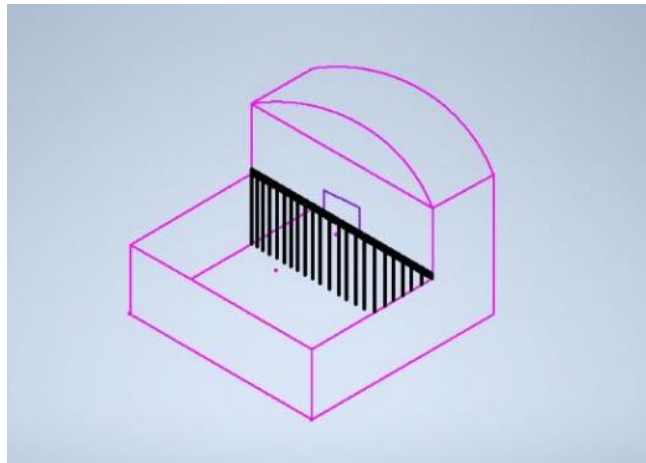
### 3.2 PROJECT DESIGN



**Figure 3.1:** Flow Chart

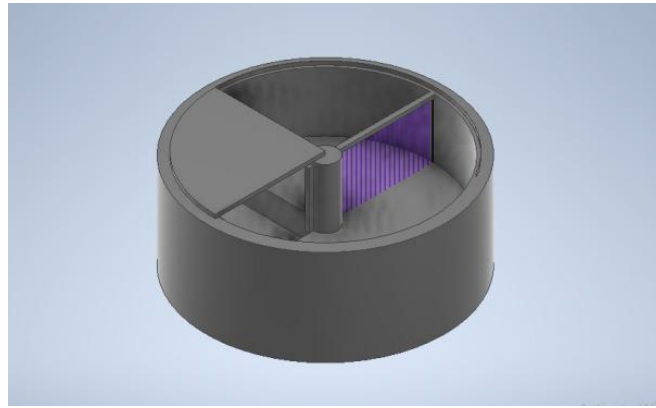
### 3.2.1 Method/Procedure

In this process each of group member design their own cat litter box with different concept using Inventor software. After the design was completed, we made an evaluation for each of the design and choose the best design and work concept.



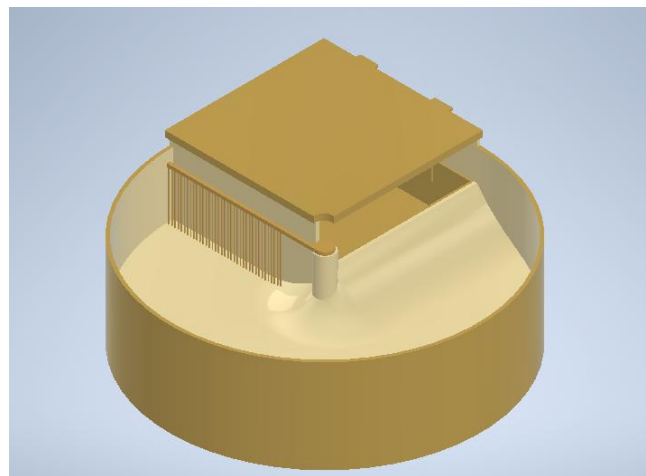
**Figure 3.2:** First Concept

The first concept design has a simple work mechanism. The scoop moves in a straight line along the platform. The waste is pushed the entire time when the scoop is moving and the waste was dispose in the waste compartment at the end of the platform. The product is activated by using touch sensor. When the sensor detects that there is waste in the litter box, the scoop will automatically move to dispose the waste. The material for the scoop is steel.



**Figure 3.3:** Second Concept

The main concept of this second design is that the platform moves in circular motion for 360° and the scoop is fixed in place. This cat litter box design is activated by using smart phone via bluetooth. The platform then will move in slow motion and the waste will be captured on the scoop and fell in the waste compartment during the lap. The material used for the scoop is plastic.



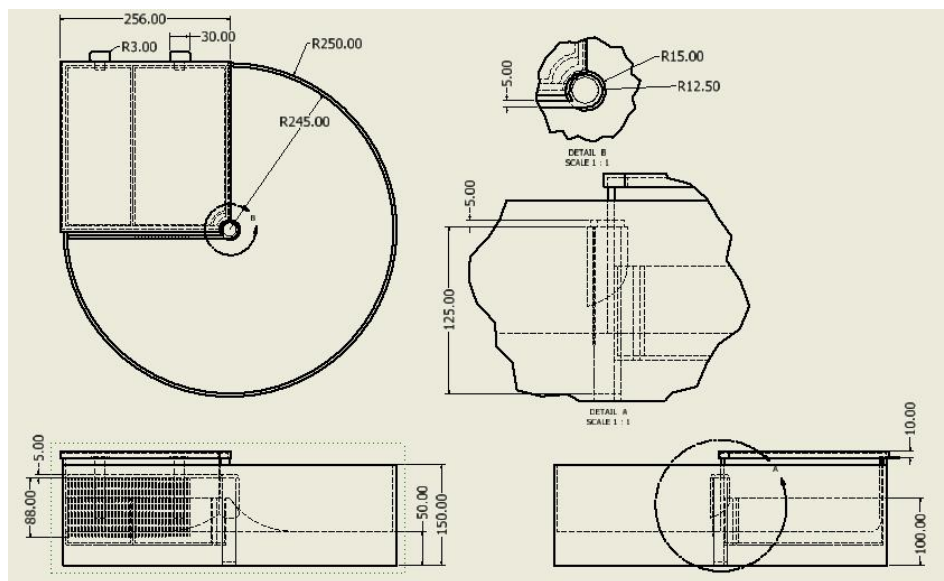
**Figure 3.4:** Third Concept

In this third design, the scoop is the one that moves in circular motion for 270°. This design is activated using Google voice assistant, the scoop the moves and capture the waste and drag it along the platform. The platform was slightly increased at the end of the scoop rotation. The waste then fell into the waste compartment. After one complete cycle for 270°, the scoop then return to original position. Material for the scoop is steel.



### 3.2.2 Product Specification

After third concept design was chosen as our product design, we draw the product plan with more detail and measurement such as height, size, area and diameter to facilitates the fabrication progress during project 2. This specification also were determine by the survey we have done, which is one of the customer suggest that we make a bigger design for those who has larger cat breads.



**Figure 3.5:** Cat Litter Box Drawing Specification

### 3.2.3 Material Selection

Before fabrication process, we need to decide what material should be use for each part of the components. Material selection are important because it help to determine the resilience of the product when it is fabricated. Strength and durability of the product is taken into account to prevent the product from failing during testing in project 2 and data collection process. These are the parts and material used for the parts:

#### a) Litter Box

Material use for the the litter box is corrugated board. Corrugated board can be bend into shapes easier and it is water resistance.



**Figure 3.6:** Corrugated Board

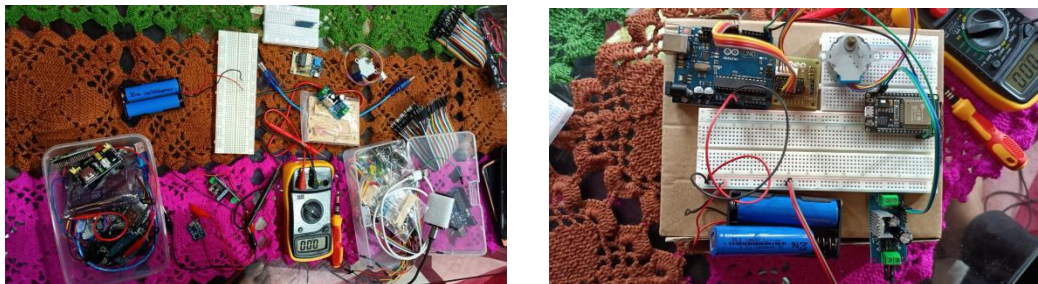
#### b) Scoop

Material that we are going to use for scoop part is stainless steel rod. The diameter of the rod is approximately 2mm. The rod is going to be worked and formed to be a scoop. The reason we choose stainless steel is that when cats urinate in the litter, the rod are going to be exposed with the urine during disposing process and started to rust.

### 3.2.4 Fabrication

- **Electrical and Mechanical Parts**

Figure 3.7 below shows how electrical part was done by Firdaus, he assemble all the components such as Arduino Uno, breadboard, jumper wire and many more to complete the mechanism.



**Figure 3.7:** Electrical Parts Assembly

- **Body Parts**

Body parts was done by all three of us, it started with cutting the base of the product.



**Figure 3.8:** Base Cutting Process

The next step is to separate the base plywood with upper platform by cutting PVC pipe and attach it to the base using hot glue gun.



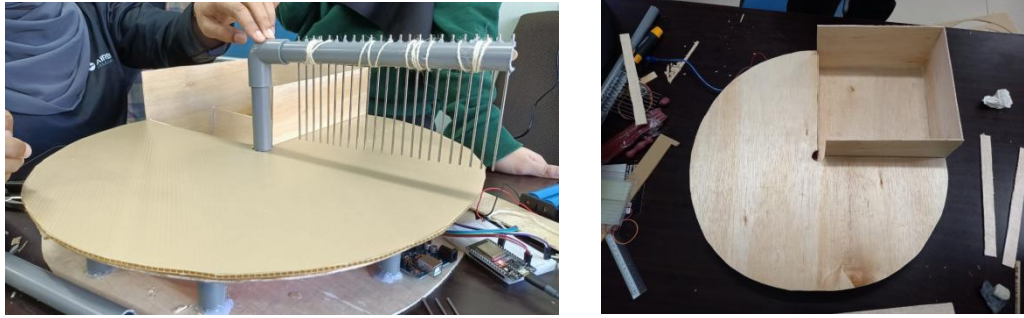
**Figure 3.9:** PVC Pipe Cutting and Attaching Process

Eleven PVC pipe was attach to the base to strengthen the upper platform. Piece of plywood that has the same diameter as the base was placed on top of the PVC pipes.



**Figure 3.10:** Platform Fabrication Process

Scoop was attached to stepper motor that was under the upper platform and waste compartment section was done using plywood.



**Figure 3.11: Scoop and Waste Compartment Fabrication**

Cover of the body was done by bending the corrugated board and attach it to the side of the product.



**Figure 3.12: Body Cover Fabrication**

After done some finishing on the edge of between the platform and the wall of the body, the product is complete and several test was done to see the outcome.



**Figure 3.13: Final Product**

### 3.2.5 Materials and Tools

**Table 3.1:** Materials & Tools Cost

No	Material	Quantity	Price (RM)	Total (RM)
1	Arduino Uno	1	35.5	35.5
2	Arduino Node MCU IoT (Wifi)	1	25	25
3	Battery Holder	2	2.5	5
4	Breadboard 400 Holes	1	2.9	2.9
5	Jumper Wire	2	2.5	5
6	Stepper Motor	1	3.2	3.2
7	18650 Battery (Flat Top)	2	5	10
8	Solar Panel (12V)	1	22.5	22.5
9	TP4056 Charging Board	2	1.5	3
10	Voltage Regulator (5V & 9V)	2	5	10
11	Soldering Iron (60 W)	1	19.9	19.9
12	Soldering Wire	1	6	6
Total Cost (RM)				148

#### 1) Arduino Uno

Arduino is an open-source electronics platform based on easy-to-use hardware and software [1]. Arduino boards are able to read inputs up to 37 types of sensors. It can demand the board what to do by sending a set of instructions to the microcontroller on the board. To do so it will use the Arduino programming language and the Arduino Software (IDE).

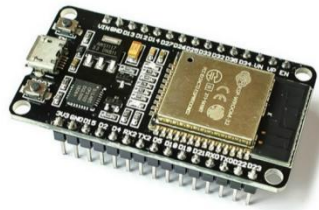


**Figure 3.14:** Arduino Uno



## 2) Arduino Node MCU IoT (wifi)

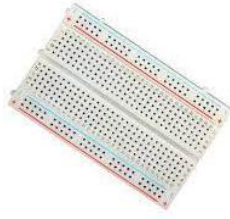
NodeMCU is a low-cost open source IoT platform. It initially included firmware which runs on the ESP8266 Wi-Fi SoC from Espressif Systems, and hardware which was based on the ESP-12 module. Later, support for the ESP32 32-bit MCU was added. In this project the ESP32 will be used to integrate 802.11b/g/n HT40 Wi-Fi transceiver, so it can not only connect to a WiFi network and interact with the net, but it is also able to establish a network of its own, allowing other devices to connect directly to it. The ESP32 supports WiFi Direct as well, which could be a good option for peer-to-peer connection without the necessity of an access point. The WiFi Direct is simpler to setup and also the data transfer speeds are much better than Bluetooth [2].



**Figure 3.15:** Arduino NodeMCU ESP 32

## 3) Breadboard 400 Holes

A breadboard is a rectangular board that is known to be a platform to build and test an electrical connection between electronic components circuits. It has many mounting holes with different sizes that does not need any soldering. Unlike soldering, the connection can be placed and removed any time as it is not a permanent connection. The parts of the breadboard are wired together to allow the electricity to flow between components in orderly rows. The breadboard can also be used as experimental based circuits with ideas to build any device directly on it [3].



**Figure 3.16:** Breadboard

#### 4) Jumper Wire

Jumper wires are simply wire that have connector pins at each end, allowing them to be used to connect two points to each other without having to use soldering technique. Jumper wires are typically used with breadboards and other prototyping tools in order to make it easy to change a circuit as needed and it is fairly simple [4].



**Figure 3.17:** Jumper Wire

#### 5) Stepper Motor

A stepper motor is a brushless, synchronous electric motor that converts digital pulses into mechanical shaft rotation. Every revolution of the stepper motor is divided into a discrete number of steps but most common is cases to 200 steps, and therefore the motor must be sent a separate pulse for each step. The stepper motor can only take one step at a time and each step is the same size [5].



**Figure 3.18:** Stepper Motor

## 6) Charging Board (TP4056)

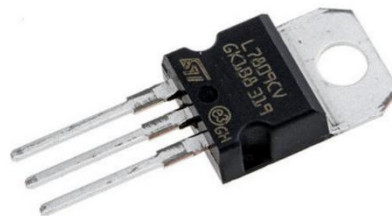
A lithium battery charging board is a module that is used for recharge lithium batteries. The term board is coined because the charging circuit is assembled on a board made of wood or some insulating material for preservation purpose. The charger breakout board is mostly based on the TP4056 circuit. It uses a micro USB for connection between the breakout board and also the USB wall adapter. TP4056 is a current linear charger for single-cell lithium-ion batteries [6]. This charging board also keeps batteries optimally charged when connected to a charger.



**Figure 3.19:** Charging Board

## 7) Voltage Regulator

The main purpose of a voltage regulator is to keep the voltage in a circuit relatively near to desired value. Voltage regulators are one amongst the foremost common electronic components, since a power supply frequently produces raw current that might otherwise damage one of the components in the circuit. Voltage regulators have a range of specific functions, depending on their particular application [7].



**Figure 3.20:** Voltage Regulator

## 8) Soldering Iron



A soldering iron is an apparatus used to heat solder, usually from an electrical supply at high temperatures above the melting point of the metal alloy. This allows for the melted solder to flow in between the workpieces that need to be joined [8].



**Figure 3.21:** Soldering Iron

### 9) Soldering Wire

Wire solder is a fusible metal alloy with a melting point that is low enough to be melted with a hand tool such as soldering iron or soldering gun while still having the attributes to satisfy specific applications. Solder is employed to bond metal work pieces together and its applications are extensive [9].



**Figure 3.22:** Soldering Wire

### **3.2.6 Data Analysis Method**

In this process, data are collected and analysed to see if our product has achieved the target, fully fill the problem and to detect if there is any fault in the product. Data that are going to be collected during this process is:

#### **i. Survey Research**

Survey research is defined as the collection of information from a sample of individuals through their responses to questions. The survey will include questions such as demographic information, the usage of cat litter box, innovation and suggestions. It will be distributed to 164 respondents. From this method, we will get to know the current market demand.

#### **ii. Litter box Efficiency**

After all product testing is completed, some data are going to be collected. By testing our actual product using actual cat's faeces. We are going to calculate the efficiency of the scoop when collecting the faeces and dispose it in waste compartment per rotation. We also going to calculate percentage of sand litters that are going to be disposed along with the faeces during the rotation. Next, things that we are going to take into account is that the odour of the faeces when it is collected in the waste compartment in certain amount of time and when are we suppose to dispose all the faeces collected in the waste compartment.

### **3.3 SUMMARY**

In a nutshell, this chapter contain full information about explanations and justifications of the product's design including the total cost of the product. All the material are carefully picked to ensure it can cater the main function of the product with a slick design.

## **CHAPTER 4 FINDING AND ANALYSIS**

(MUHAMMAD FIRDAUS BIN RAIHAN)

### **4.1 INTRODUCTION**

This chapter covers all of the “Automatic Cat Litter Box” important data and analysis. The data is very important to ensure that the project’s objective and scope are achieved. If the data analysis meets the objective, it indicates that our project was success. So, in order for this initiative to go properly, we’ve decided to gather all relevant data to investigate each case in order for this project to go off without a hitch.

### **4.2 FINDINGS DATA**

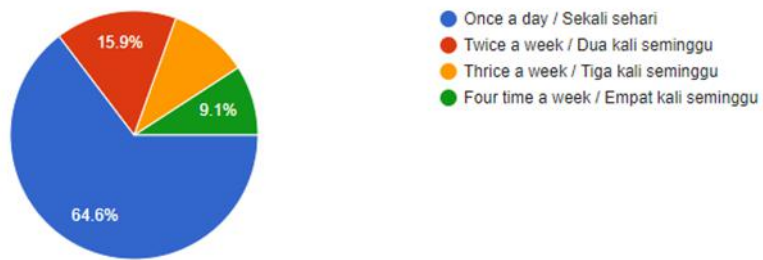
The results presented in this chapter was gained through questionnaires. The data experiments are examined in greater depth in order to develop conclusions based on the stated objectives. The results obtained from the public questionnaires that we provided in the platform “Google Form” and about 160 respondents participated in the survey.

The main focus is on various factors, including:

1. Demographic Information
2. General view of the study
3. The Innovation of Automatic Cat Litter Box

How frequent do you need to clean up your cats' waste? / Berapa kerap anda perlu membersihkan najis kucing anda?

164 responses

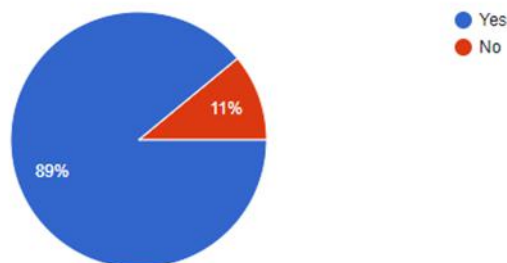


**Figure 4.1:** How Frequent Cat Owner has to Clean Litter Box

The diagram above shows the frequency of respondents in cleaning their cat litter box. A total of 106 respondents, or 64.5% of respondents clean their litter box at least once a day. It shows that litter box is very important in daily life and most of them always use the litter box that was handle by manual.

Do you think by using Automatic Cat Litter Box will be easier for you? / Adakah anda rasa bahawa menggunakan Automatic Cat Litter Box lebih menyenangkan anda?

164 responses

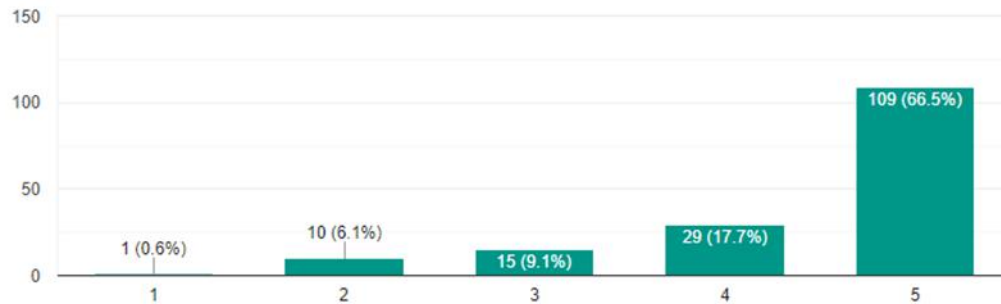


**Figure 4.2:** Data of People Who Agree and Disagree about the use of Cat Litter Box

The diagram shows that 89% of the respondents think that automatic cat litter box will be easier for them. This is because the manual litter box is complicated to use and will be taking a long time to clean it. Furthermore, people are tending to use automatic cat litter box because they are too tired to clean the litter box by manual if they go back from work.

Do you agree if we implement Internet of Things (IoT) such as bluetooth, remote controls, etc on the product so that it can be controlled from long distance? / Adakah anda bersetuju jikalau kami menggunakan Internet of Things (IoT) seperti bluetooth, alat kawalan jauh dan sebagainya supaya produk ini dapat dikawal dari jarak jauh?

164 responses



**Figure 4.3:** Percentage of People Who Agree with IOT Concept

Diagram shows that 109 out of 164 respondents strongly agree if we implemented Internet of Things (IoT) in our product. The IoT will help people to clean their cat litter box easily by using smartphone that connected to the litter box.

According to the survey results, the Automatic Cat Litter Box got the satisfactory result from all the respondents. This means that our Automatic Cat Litter Box have something unique that every cat litter box out there didn't have. Respondents gave favourable feedback and it shows respondents like our product since it would make cleaning the litter box easier for them.

### 4.3 TEST RESULTS

Once the project was completed, several testing was done to make sure that some of the data was taken into account. The time it takes for the scoop to make a one complete cycle, the maximum mass of waste that can be pushed by the scoop, the percentage of waste that can be pushed by the scoop to the waste compartment, and the percentage of cat litter that is pushed by the scoop to the waste compartment are some of the data that we consider. We may draw inferences about our cat litter box based on the information we have and compare them to other cat litter boxes on the market.

1. Time to make one complete cycle.

The time it takes for stepper motor to make a complete cycle is determined by various factors. The less torque a stepper motor has, the faster it rotates. In our project, we set the stepper motor's speed at 30rpm, which was the optimal value. The stepper motor will overheat and break down if the speed is reduced even further. One complete rotation takes roughly 55 seconds at a stepper motor speed of 30rpm and a turn of 270°. This period of time can help to prevent any accidents or injuries to cats, as well as improve the safety of our products.

2. Maximum mass that can be pushed by stepper motor.

To determine the total mass that the stepper motor can push, numerous factors must be considered, including scoop mass, maximum waste mass, and litter depth. The scoop weighs 100g and the depth of the litter is about 1 inch. The waste mass in the first experiment was 20g, and in the subsequent experiments, we added a waste mass of 10g to each experiment, making the waste mass 30g, 40g, 50g, and so on. On the 7th experiment, the stepper motor was at its limit and the maximum mass that could be pushed was 80g. As a result, the maximum mass that the stepper motor can push is  $100g + 80g = 180g$ .

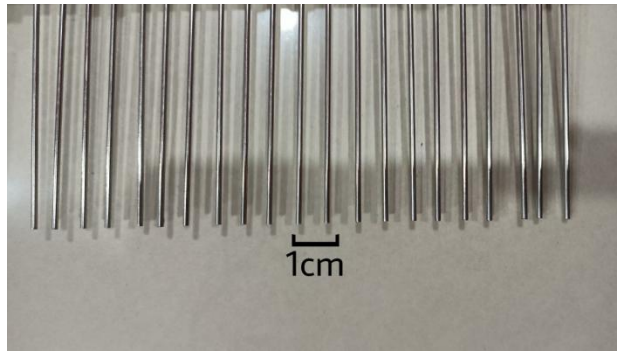


**Figure 4.4:** Weight of the Waste and Scoop

3. Percentage of waste to be scooped up.

To determine the percentage of waste that can be scooped into the waste compartment, several waste sizes were studied and experimented. The probability for large -sized waste to be pushed into the waste compartment is higher than for small-sized waste. This is because the distance between the stainless steel rod in

the scoop has a distance of 1cm between each other. If the waste is less than 1cm in size, the probability of it to miss from being scooped is higher. It is a bit impossible for an adult cat to have a waste measuring less than 1cm. After several experiments, we found that the percentage of waste that can be pushed by the scoop into the waste compartment is approximately 99%.



**Figure 4.5:** Distance Between Each Rod

#### 4. Percentage of litter to be scooped up.

When the scoop pushes the waste, there is a small amount of litter that is pushed into the waste compartment. The percentage of the litter to be pushed depends on the type of litter and the size of the litter. Our project is more suitable to use a small type of litter because the distance of the scoop rod has a small size so that it can push the small size of waste. We made an experiment by comparing two types of litter available in the market. Litter 1 has a low percentage to be scooped up which is about 0.5% compared to litter 2 which has a percentage of 40%.

##### i. Litter 1



**Figure 4.6:** Cat Litter Type 1

ii. Litter 2



**Figure 4.7:** Cat Litter Type 2

**Table 4.1:** Data Taken from Test

<b>NO.</b>	<b>TEST</b>	<b>RESULT</b>
1	Time taken (s)	55
2	Mass (g)	180
3	Waste scooped (%)	99
4	Litter scooped (%)	0.5

#### **4.4 ADVANTAGES**

i. Save time

With the implementation of Internet of Things (IoT) to our Automatic Cat Litter Box, we have saved time and energy to clean up cat waste. Users only need to press the push button on the phone or use voice assistance to clean up the cat waste instead of using their hands manually which takes a long time to do so.

ii. Safety

Our Automatic Cat Litter Box have a safety features for cats. This is because the time taken for the scoop to do one complete cycle takes a long time which is approximately 55s. With this slow movement of the scoop, any possibility of



accident can be avoided to the cat and if the scoop is moving and hits the cat, it will not cause any injuries to the cat.

#### **4.5 SUMMARY**

As a summary at the end of this chapter, this chapter has described the findings and analysis of the Automatic Cat Litter Box and a number of analyses have been discussed. Several test have been run to test some aspects in order to get the best results. Each project has its own advantages and disadvantages. We have tried our best to get the best outcome which benefit the people and the community. We also made some changes to our products based on suggestions from respondents so that our products are user friendly and get the best outcome.

## **CHAPTER 5 RECOMMENDATION**

(MIA SYAFIQA AFIRA BINTI MARZUKI)

### **5.1 INTRODUCTION**

The entire project's discussion, conclusion, and upgrade plan are covered in this chapter. The research was carried out using data from the project's test run. As a result, the description of all test run findings and interpretation will be explained in this chapter. Finally, depending on the outcome of the discussion and the improvement plan that has been developed.

### **5.2 CONCLUSION**

The study investigated the possibility of making a manual cat litter box into an automated cat litter box, which could be a huge help to humans while they are busy working. Although an automated cat litter box has some drawbacks, it is an effective tool for reducing the amount of manual labour required.

All the data has been collected by using questionnaire via Google Form that has been distributed publicly to cat owners. There are 164 respondents that contributed to the survey.

According to the results of a survey of cat owners, switching to an automated cat litter box can assist cat owners in reducing their workload by cleaning the feces more effectively. Aside from that, all the project's objectives have been met with great success. Following the completion of the questionnaire, it was discovered that 146 (89 %) of the 164 respondents believe that an automatic cat litter box will make their lives easier. Moreover, the adaptation of Internet of Things (IoT) can pave the way for a more promising future as an upgrade and improvement in the wake of Fourth Industrial Revolution (IR 4.0).

### **5.3 RECOMMENDATIONS**

Based on the findings and conclusion of the study, here are several recommendations that can be considered in the future:

- Provide a perfume sprayer to ensure that the litter box kills bacteria and remains odour-free.
- Build a safety precaution for the cat to ensure they are not harmed or that an incident such as being electrocuted or stuck does not occur.
- Build an automated cat litter box that can use renewable energy such as solar energy.

### **5.4 LIMITATIONS**

Initially the product was intended to run by using solar energy but due to knowledge gaps, battery was used as a substitute to ensure the project can be completed successfully.

### **5.5 SUMMARY**

To summarise, the project was a success. The project is capable of achieving all of the suggested objectives. The product is clearly needed by cat owners based on the results of the questionnaire. Automated cat litter boxes may become one of the most in-demand products in the near future, as there are currently unavailable in Malaysia.

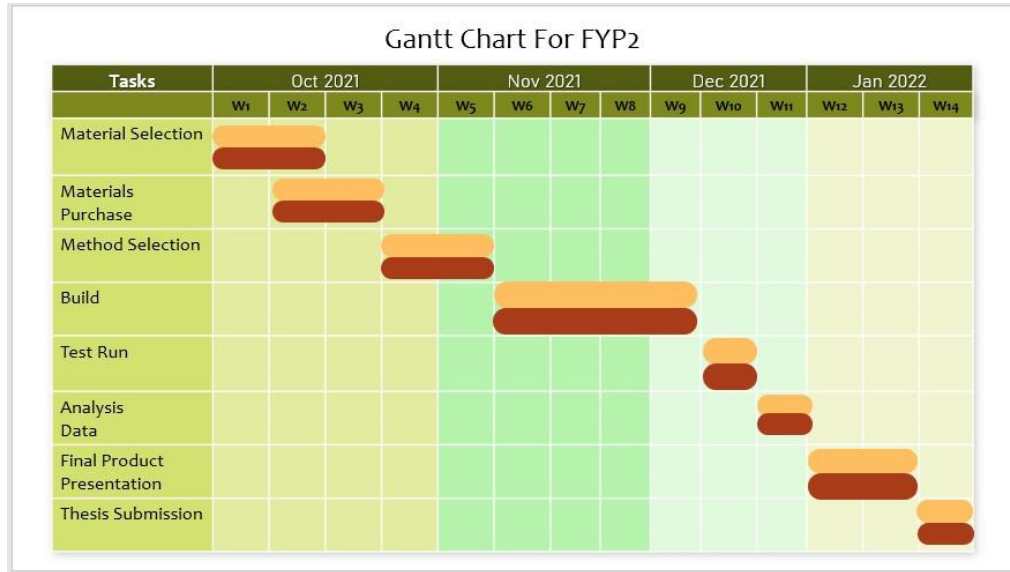
## REFERENCES

- [1] V. Solar, "A Sunrun Company," 2021. [Online]. Available: <https://www.vivintsolar.com/learning-center/history-of-solar-energy>.
- [2] S. Andrade, "A COMPLETE GUIDE TO SOLAR PANELS IN 2020," The Renewable Energy Hub, 15 March 2019. [Online]. Available: <https://www.renewableenergyhub.co.uk/main/solar-panels/the-history-of-solar-power/>.
- [3] A. Gemmel, "Solar Choice," Solar Choice Pty Ltd, 15 January 2019. [Online]. Available: <https://www.solarchoice.net.au/invention-and-history-of-solar-panels/>.
- [4] M. Dhar, "How Does Solar Panel Works?," LiveScience, 7 December 2017. [Online]. Available: <https://www.livescience.com/41995-how-do-solar-panels-work.html>.
- [5] L. Richardson, "Solar panels work," Energy Sage, 5 April 2021. [Online]. Available: <https://news.energysage.com/solar-panels-work/>.
- [6] R. Hantula, How Do Solar Panels Work?, Science Curriculum Resource Teacher, 2009.
- [7] N. Berg, "What will happen to solar panels after their useful lives are over?," 11 May 2018. [Online]. Available: <https://www.greenbiz.com/article/what-will-happen-solar-panels-after-their-useful-lives-are-over#:~:text=But%20the%20solar%20panels%20generating,t%20long%20from%20being%20retired..> [Accessed 5 May 2021].
- [8] "What is Arduino?," Arduino cc, 11 December 2019. [Online]. Available: <https://www.arduino.cc/en/guide/introduction>.
- [9] N. Zlatanov, "Arduino and Open Source Computer Hardware and Software," ResearchGate, 1 November 2015. [Online]. Available: [https://www.researchgate.net/publication/297734853\\_Arduino\\_and\\_Open\\_Source\\_Computer\\_Hardware\\_and\\_Software](https://www.researchgate.net/publication/297734853_Arduino_and_Open_Source_Computer_Hardware_and_Software).
- [10] CircuitSchools, "What is Arduino, how it works and what you can do with arduino," Circuitschool, 30 May 2020. [Online]. Available: <https://www.circuitschools.com/what-is-arduino-how-it-works-and-what-you-can-do-with-arduino/>.
- [11] Elprocus, "What are the Different Types of Arduino Boards," Elprocus, 23 January 2019. [Online]. Available: <https://www.elprocus.com/different-types-of-arduino-boards/>.
- [12] Y. Zhang, "Introduction to Mechanisms," Carnegie Mellon University, 29 February 2020. [Online]. Available: <https://www.cs.cmu.edu/~rapidproto/mechanisms/chpt2.html>.
- [13] D. R. L. W. II, "A Bulleted/Pictorial History of Mechanisms and Machines," Dr. Bob Productions, 3 December 2021. [Online]. Available: <https://www.ohio.edu/mechanical-faculty/williams/html/PDF/HistoryOfMechanisms.pdf>.
- [14] T. E. o. E. Britannica, "Linkage," Britannica, 25 December 2019. [Online]. Available: <https://www.britannica.com/technology/linkage-machine-component>.
- [15] T. E. o. E. Britannica, "Gear," Britannica, 11 December 2019. [Online]. Available: <https://www.britannica.com/technology/gear>.
- [16] S. Padmashali, "Electric Motor," CircuitGlobe, 23 August 2017. [Online]. Available: <https://circuitglobe.com/electric-motor.html>.
- [17] Hamza, "What is a Stepper Motor : Types & Its Working," Elprocus, 19 October 2019. [Online]. Available: <https://www.elprocus.com/stepper-motor-types-advantages-applications>.

# ATTACHMENT

## ATTACHMENT A

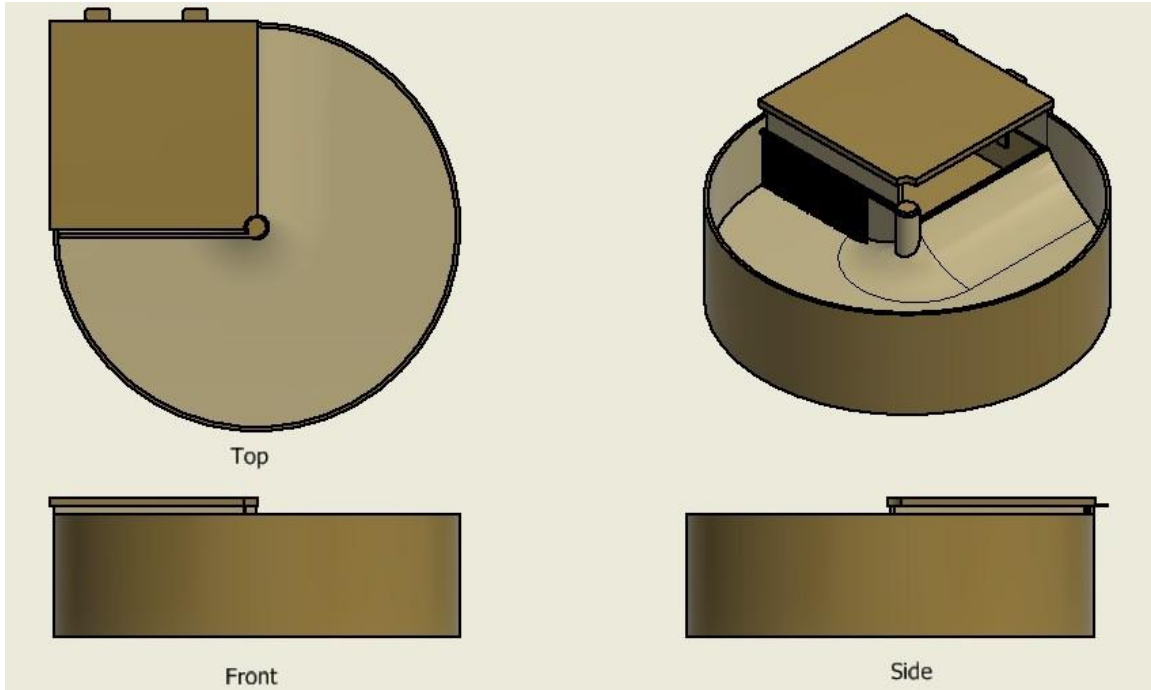
### Project Activity Planner (Gantt Chart)



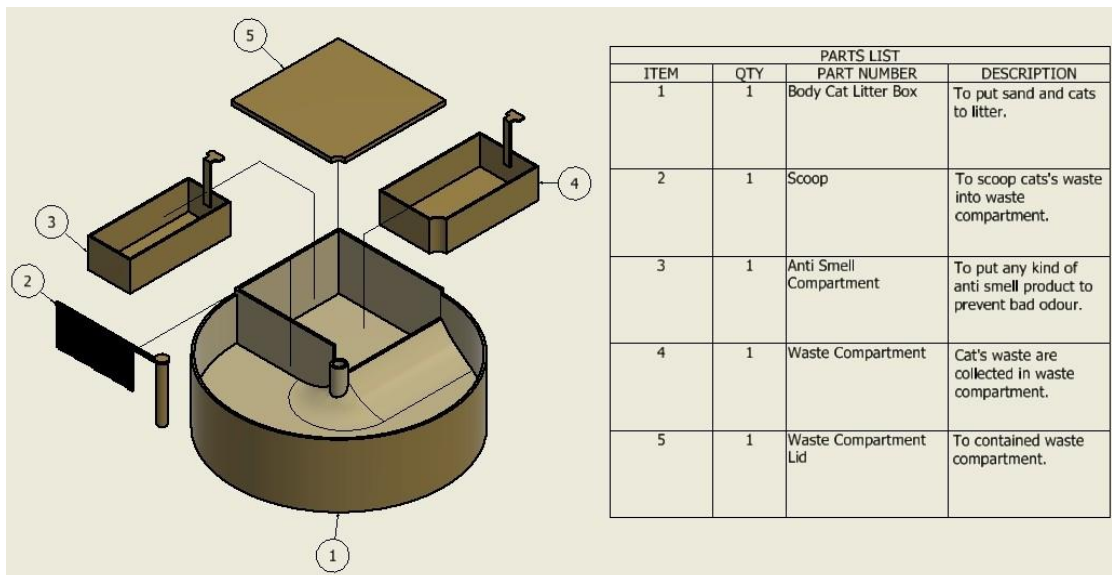
**Figure 6.1:** Gantt Chart

# ATTACHMENT B

## Product Design Specification



**Figure 6.2: 3D Drawing View**



**Figure 6.3: Assembly Part**