

POLITEKNIK SHAH ALAM

HOME AUTOMATION BASED ON IOT

NAME

REGISTRATION NO

NUR AMALINA BINTI
KAMARUL AMAN

08DJK17F2004

JABATAN KEJURUTERAAN ELEKTRIK

DECEMBER 2019

POLITEKNIK SHAH ALAM

HOME AUTOMATION BASED ON IOT

NAME

REGISTRATION NO

NUR AMALINA BINTI KAMARUL
AMAN

08DJK17F2004

This report submitted to the Electrical Engineering Department in fulfillment of the requirement for a Diploma in Electrical Engineering

JABATAN KEJURUTERAAN ELEKTRIK

DECEMBER 2019

CONFIRMATION OF THE PROJECT

The project report titled " Home Automation Based on IoT" has been submitted, reviewed and verified as a fulfills the conditions and requirements of the Project

Writing as stipulated

Checked by:

Supervisor's name : PUAN FA`IZAH BINTI YA`ACOB

Supervisor's signature:

Date :

Verified by:

Project Coordinator name :

Signature of Coordinator :

Date :

“I acknowledge this work is my own work except the excerpts I have already explained to our source”

1. Signature :

Name : **Nur Amalina Binti Kamarul Aman**

Registration Number : **08DJK17F2004**

Date :

DECLARATION OF ORIGINALITY AND OWNERSHIP

TITLE : HOME AUTOMATION BASED ON IOT

SESSION: DECEMBER 2019

1. I, **1. NUR AMALINA BINTI KAMARUL AMAN (08DJK17F2004)**

is a final year student of **Diploma in Electrical Engineering, Department of Electrical, Politeknik Shah Alam**, which is located at **40150, Shah Alam, Selangor**. (Hereinafter referred to as 'the Polytechnic').

- 2. I acknowledge that 'The Project above' and the intellectual property therein is the result of our original creation /creations without taking or impersonating any intellectual property from the other parties.
- 3. I agree to release the 'Project' intellectual property to 'The Polytechnics' to meet the requirements for awarding the **Diploma in Electrical Engineering** to me.

Made and in truth that is recognized by;

a) **Nur Amalina Binti Kamarul Aman**
(Identification card No: - 990511145048)

) .
.....
) **NUR AMALINA
BINTI KAMARUL
AMAN**

In front of me, **PUAN FA`IZAH BINTI
YA`ACOB** (Click here to enter text.)
As a project supervisor, on the date:

)
) Click here to enter text.

ACKNOWLEDGEMENTS

Through this acknowledgement, I would like to express my sincere gratitude to my institute Politeknik Sultan Salahuddin Abdul Aziz Shah for providing me an opportunity to undertake and complete such an interesting project and for those people who have been associated with this project and have helped us with it and made it a worthwhile experience. Firstly, I would like to extend my thanks to the Final Year Coordinator who arranged and managed all the presentation and understood all of our problems in a good manner and effectively. Without lecturer management skills I might have faced a lot of problems.

Secondly, I would like to thank the Final Year project committee, who attended each and every presentation and listened to our project-related problems and presented solutions and opinions. In the last I would like to take this opportunity to express a deep sense of gratitude to our Final Year project Supervisor for their cordial support, exemplary guidance, monitoring and constant encouragement.

I am obliged to our batch fellows and parents for their valuable guidance and co-operating during the period of this task. Their blessing, help and guidance was a deep inspiration to me.

ABSTRACT

The home automation system is implemented for decades but due to the costing and budgeting of the project, it remains a niche product for high-end consumers. The Intelligent Home Automation System, security is one of the major factors that does not implement the home automation system. The hectic daily life routine sometimes makes them forgetful to switch off the devices at home. The clumsiness attitude plus with our packed daily routine life that sometimes makes ourselves such in hurry situation that sometimes makes us forgot to switch off the lamps. It will cause the electricity bill rose sharply. Besides, it is one of the electricity wastage that will lead the earth became an unhealthy one. The strength of this project is to control the devices such as lamp and door at home using a smartphone. The system is related to home appliances using NODEMCU. Home appliances that can help the user to control the devices at home and develop a good condition of house area that will prevent any loss and damage to the property of any organization. The hardware that is being used in this project is a relay, servomotor, bulb holder and bulb. Meanwhile for the software part is Telegram. Telegram is the main software that is being used in this project. Telegram application is being used as a platform to give the command. Most of the project that is related to home automation or known as home appliances most of it using the Blynk apps and rarely uses the telegram. This project is using a smartphone to give command compare to another project that is using tablet, laptop and others which is much more convenient to users.

TABLE OF CONTENTS

CONFIRMATION OF THE PROJECT	i
DECLARATION OF ORIGINALITY AND OWNERSHIP	iii
ACKNOWLEDGEMENTS	iv
ABSTRACT	v
ABSTRAK	Error! Bookmark not defined.
TABLE OF CONTENTS	vi
LIST OF TABLES	ix
LIST OF FIGURES	x
CHAPTER 1	1
INTRODUCTION	1
1.1 Introduction	1
1.2 Background Research	2
1.3 Problem Statement	3
1.4 Research Objectives	3
1.5 Scope of Research	3
1.6 Project Significance	4
1.7 Chapter Summary	4
CHAPTER 2	5
LITERATURE REVIEW	5
2.1 Introduction	5
2.2 Microcontroller selection for home appliances	5
2.2.1 Previous Research	5
2.3 Control System	6
2.3.1 Microcontroller	7
2.3.2 NODEMCU	7
2.4 Chapter Summary	7
CHAPTER 3	8
RESEARCH METHODOLOGY	8
3.1 Introduction	8
3.2 Project Design and Overview.	8
3.2.1 Block Diagram of the Project	8
3.2.2 Flowchart of the Project 2	9
3.3 Project Hardware	10
3.3.1 Schematic Circuit	10
3.3.2 Description of Main Component	10
3.3.2.1 Component 1 : RELAY	11
3.3.2.2 Component 2 : SERVOMOTOR	11
3.3.2.3 Component 3 : STEP DOWN TRANSFORMER	11
3.3.2.4 component 4 :ADAPTER	12
3.3.3 Circuit Operation	12
3.4 Project Software	13
3.5 Prototype Development	13
3.5.1 Mechanical Design/Product Layout	14

3.6	Sustainability Element in The Design Concept	14
3.7	Chapter Summary	14
CHAPTER 4		15
RESULTS AND DISCUSSION		15
4.1	Introduction	15
4.2	Results and Analysis	15
4.3	Discussion	16
4.4	Chapter Summary	16
CHAPTER 5		17
CONCLUSION AND RECOMMENDATIONS		17
5.1	Introduction	17
5.2	Conclusion	17
5.3	Suggestion for Future Work	17
5.4	Chapter Summary	17
CHAPTER 6		18
PROJECT MANAGEMENT AND COSTING		18
6.1	Introduction	18
6.2	Gant Chart and Activities of the Project	18
6.3	Milestone	19
6.4	Cost and Budgeting	22
6.5	Chapter Summary	23
REFERENCES		24
APPENDICES		25
APPENDIX A-	DATA SHEET	25
APPENDIX B-	PROGRAMMING	25
APPENDIX C-	PROJECT MANUAL/PRODUCT CATALOGUE	25

LIST OF TABLES

TABLE	TITLE	PAGE
Table 2.1:	differentiator of microcontroller	5
Table 6. 1:	Gant Chart for Project 1 in Semester 4	18
Table 6. 2:	Gant Chart for Project 2 in Semester 5	18
Table 6. 3:	Milestone for Project 1 in Semester 4	19
Table 6. 4:	Milestone for Project 2 in Semester 5	20
Table 6. 5:	Milestone Bar for Project 1 in Semester 4	20
Table 6. 6:	Milestone Bar for Project 2 in Semester 5	21
Table 6. 7:	Cost Estimation Project	22

LIST OF FIGURES

FIGURE	TITLE	PAGE
Figure 2. 2:	Block diagram of home automation.....	6
Figure 3. 1:	Block diagram of the Project.....	8
Figure 3. 2.1:	Flow chart of operation of the system.....	9
Figure 3. 3:	Circuit Diagram.....	10
Figure 3. 4:	Command that has been given through Telegram application.....	12
Figure 3. 5.1:	Circuit of prototype Development.....	13
Figure 3. 7:	Front view and back of the project.....	14

CHAPTER 1

INTRODUCTION

1.1 Introduction

A smart home incorporates sensors, actuators, middleware, and a network and has two major interacting components which is a smart network and a smart load. The Smart home known as House automation, with the use of new technology, to make the domestic activities more convenient, comfortable, secure and economical.

The Internet of things can be defined as connecting the various types of objects like smart phones, personal computer and Tablets to internet, which brings in very newfangled type of communication between things and people and also between things. With the introduction of IoTs, the research and development of home automation are becoming popular in the recent days. Many of the devices are controlled and monitored for helps the human being. Additionally various wireless technologies help in connecting from remote places to improve the intelligence of home environment. An advanced network of IoT is being formed when a human being is in need of connecting with other things. IoTs technology is used to come in with innovative idea and great growth for smart homes to improve the living standards of life. Internet helps us to bring in with immediate solution for many problems and also able to connect from any of the remote places which contributes to overall cost reduction and energy consumption.

1.2 Background Research

The process of improving and upgrading the living standard of the house has been raised due to the advanced technology applied in this era society. Home Automation System is implemented for decades but due to the costing and budgeting of the project, it still remains as a niche product for high end consumers. Although the concept of smart home automation has been around for quite a long time, but an actual smart home has only established a short time. The invention of home appliances such as a television with a remote control which is a simple home automation system was patented in 1893 . Other than that, more home appliances have been invented since that. In early 2000, the popularity of smart home automation began to increase due to different of technology started to arise. Smart home automation turns into a more affordable choice and therefore a viable or available technology for consumers. With the uprising of the prestige of smart home, home networking, domestic technologies and other gadgets began to emerge on store shelves Today's smart home automation are more emphasize about smart living, living greener and security. Our smart home is sustainable and it ensures that our home is not utilizing unnecessary energy. In addition, the smart home also can prevent any intruders by alerting us with alarm or send any signal to us through smartphone related application. The current trend in smart home automation includes automated lights, remotely mobile control, remote video surveillance and receiving notifications of mobile, email and text .

1.3 Problem Statement

Nowadays, people with the hectic daily life routine sometimes makes them forgetful to switch off the devices at home. As a human being we can't run from the clumsiness attitude plus with our packed daily routine life that sometimes makes ourself such in hurry situation that sometimes makes us forgot to switch off the lamps. It will causes the electricity bill rose sharply. Besides, it is one of the electricity wastage that will lead the earth to became an unhealthy ones. Besides, the elderly and the handicapped user faced problem to manually access control of light and fan instead of automation process.

1.4 Research Objectives

The main objective of this project is to control the devices such as lamp and door at home using smartphone.

1. To design one system that is related with home appliances using NODEMCU
2. To implement a home appliances that can help user to control the devices at home.
3. To develop a good condition of house area that will prevent any loss and damage to the property of any organization.

1.5 Scope of Research

1. This project is focusing on hardware and the software that is being used.
2. The emphasis is includes controller and program
3. The main controller is using NODEMCU.

1.6 Project Significance

Most of the project that is related with home automation or known as home appliances most of it have been done by using the blynk apps and rarely use the telegram to give the command. The differences in my project is NODEMCU is being used compare to others like they are using wifi module only and most of it Is using Arduino, Bluetooth, ZigBee and GSM. The similarity is we are using IOT as a platform to control the devices at home which is our devices need to connected to internet first before wanted to give command through telegram or blynk application. As in my project I am using smartphone to give command compare to the other project that is using tablet laptop and others .

1.7 Chapter Summary

To summarize, in this main controller in this project is NODEMCU and in this project is focusing in two main part which is one is hardware part and the other one is software part. The main objective or purpose in this project is to control the devices such as lamp and door at home using smartphone.

CHAPTER 2

LITERATURE REVIEW

2.1 Introduction

In Existing system, GSM based Home automation system if GPRS connection is not available then full system will not work. Cost effective: As we know most of systems are using GPRS system is expensive as compare to Wi-Fi. Data Pack requirement: Some systems are based on GPRS so for those system there is need of Data pack which we have to recharge every month. Some architecture are using Wi-Fi concept but those architecture are mostly use Raspberry pi which is expensive in cost. Still home automation system is not having some basic features like automatic control of outside light. Home automation systems are also don't have notification facility, where user can easily take action according to that notification

2.2 Microcontroller Selection For Home Appliances

In this project we will chose the microcontroller to used in this project either Arduino,NODEMCU,wifi module or GSM and other.

2.2.1 Previous Research

NODEMCU	ARDUINO UNO
128KB RAM	2KB RAM
4MBytes of ROM(flash) can store more code compare to UNO	32KB
Comes with micro USB port	Comes with USB type B connector
Small in size	Bigger than NODEMCU

Table 2.1:differentiator of microcontroller

2.3 Control System

The Home automation system that uses Wi-Fi technology . System consists of three main components; web server, which presents system core that controls, and monitors users' home and hardware interface module(Arduino PCB (ready-made), Wi-Fi shield PCB, 3 input alarms PCB, and 3 output actuators PCB.), which provides appropriate interface to sensors and actuator of home automation system. The System is better from the scalability and flexibility point of view than the commercially available home automation systems. The User may use the same technology to login to the server web based application. .If server is connected to the internet, so remote users can access server web based application through the internet using compatible web browser.

The application has been developed based on the android system. An interface card has been developed to assure communication between the remote user, server, raspberry pi card and the home Appliances. The application has been installed on an android Smartphone, a web server, and a raspberry pi card to control the shutter of windows. Android application on a smartphone issue command to raspberry pi card. An interface card has been realized to update signals between the actuator sensors and the raspberry pi card.

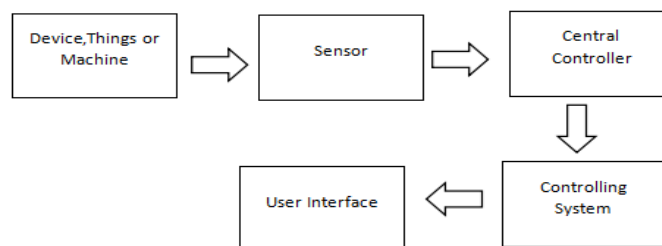

Figure 2. 2: Block diagram of Home Automation

2.3.1 Microcontroller

A microcontroller is a computer present in a single integrated circuit which is dedicated to perform one task and execute one specific application. It contains memory, programmable input/output peripherals as well a processor.

Microcontrollers are mostly designed for embedded applications and are heavily used in automatically controlled electronic devices such as cellphones, cameras, microwave ovens, washing machines, etc.

2.3.2 NODEMCU

NodeMCU is an open source IoT platform. It includes firmware which runs on the ESP8266 Wi-Fi SoC from Espressif Systems, and hardware which is based on the ESP-12 module. The term "NodeMCU" by default refers to the firmware rather than the development kits. The firmware uses the Lua scripting language. It is based on the eLua project, and built on the Espressif Non-OS SDK for ESP8266. It uses many open source projects, such as lua-cjson and SPIFFS.

2.4 Chapter Summary

This section focusing on two different section, the first is regarding the effect of the equipment if temperature of the refrigerator is not monitored. The second section is discovered about the technical part including the selection the type of controller.

CHAPTER 3

RESEARCH METHODOLOGY

3.1 Introduction

In this project is more focusing about home appliances. A step by step procedure is done so that the project can be completed in time. This include circuit design and design mechanical part.

3.2 Project Design and Overview.

As mention in previous chapter, the design home controller with NODEMCU as the main controller. The design of the controller circuit using NODEMCU is realize using Proteus Software to try run the circuit.

Telegram application is being used in this project as a platform to give a command to the project by using Telegram.

3.2.1 Block Diagram of the Project

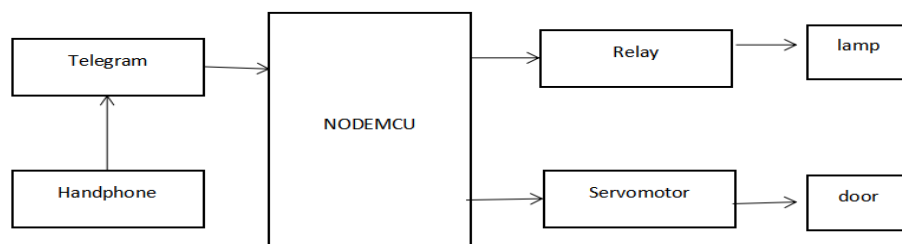

Figure 3. 1.1: Block diagram of the Project

3.2.2 Flowchart of the Project 2

Figure 3. shows the circuit diagram of the whole system. First we need to insert /12345 as a first command to get the selection of the command.If we are insert the command other than /12345 then at the telegram will show unknown command please insert again.And then after insert the /12345 command then we can proceed to control either to control the door or lamp.If we want to switch on the lamp just click swith with one command then after a few second the lamp will turn on.In a few second at the telegram will notify the lamp has been switched on.But if we clicked a lot of command in the same time then the system will hang and the progress at the project will not work exact as the command.Then we need to clear up the commad at place we give the command and start all over again.

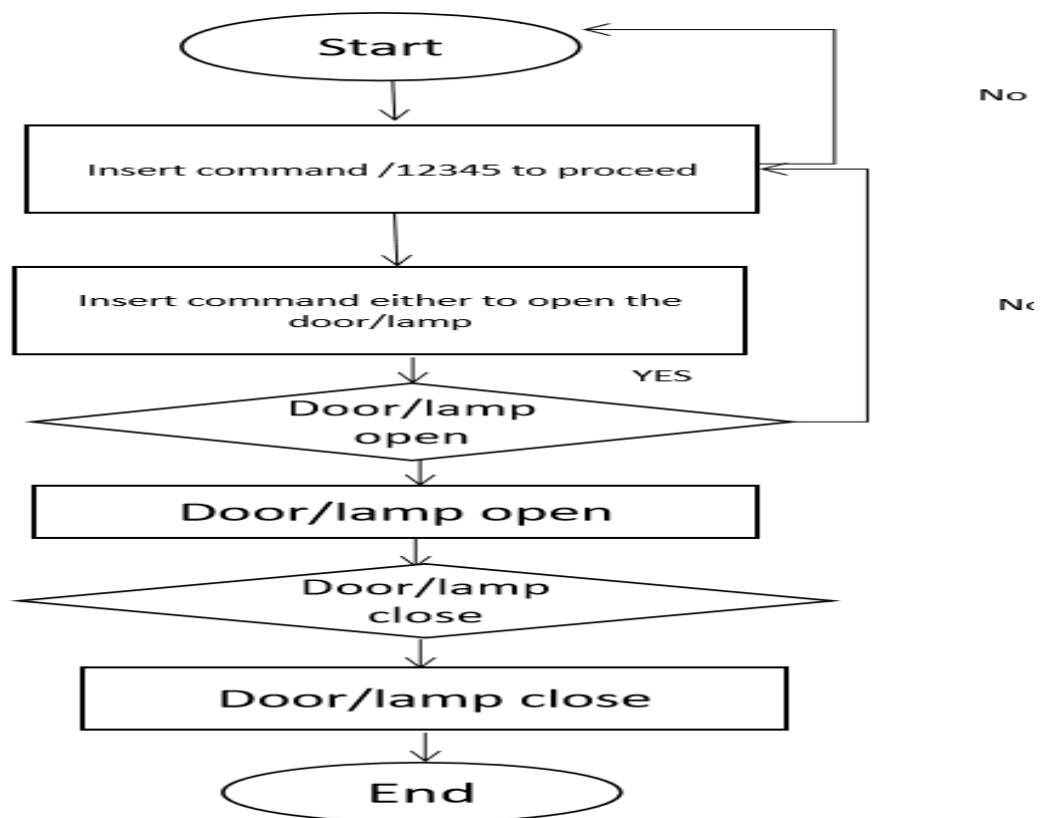

Figure 3. 2.2: Flow chart of operation of the system

3.3 Project Hardware

As mentioned in the previous chapter, the main controller is NODEMCU. In NODEMCU it contains an ESP8266 module. ESP8266 is a WiFi module, it is one of the leading platforms for the Internet of Things. It can transfer data to an IOT cloud.

3.3.1 Schematic Circuit

Figure 3.3 shows the overall circuit diagram of this project

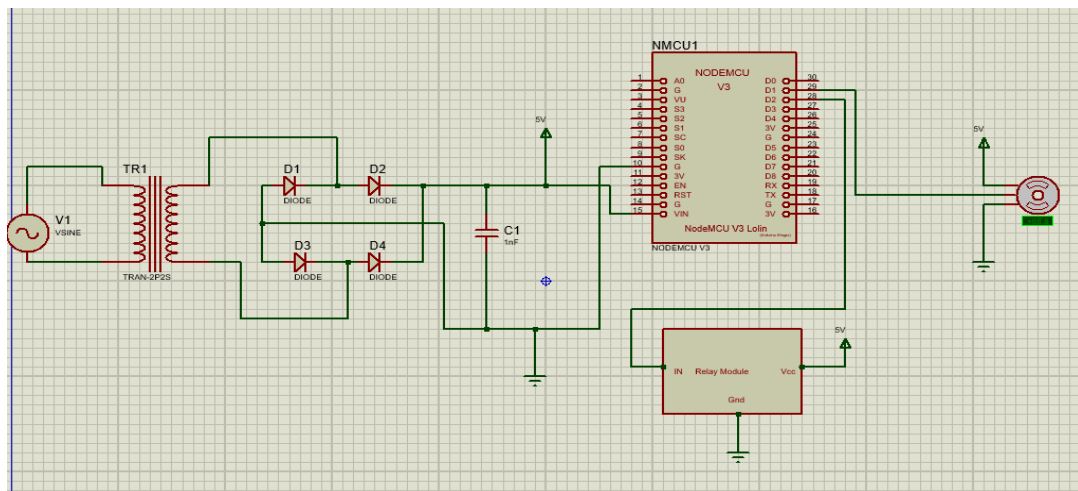

Figure 3.3: Circuit Diagram

3.3.2 Description of Main Component

The main component that has been used in this project is NodeMCU. NodeMCU is an open source IoT platform. It includes firmware which runs on the ESP8266 Wi-Fi SoC from Espressif Systems, and hardware which is based on the ESP-12 module. The term "NodeMCU" by default refers to the firmware rather than the development kits. The firmware uses the Lua scripting language. It is based on the eLua project, and built on the Espressif Non-OS SDK for ESP8266. It uses many open source projects, such as lua-cjson and SPIFFS.

3.3.2.1 Component 1 : Relay

Relays are switches that open and close circuits electromechanically or electronically. Relays control one electrical circuit by opening and closing contacts in another circuit. As relay diagrams show, when a relay contact is normally open (NO), there is an open +contact when the relay is not energized. When a relay contact is Normally Closed (NC), there is a closed contact when the relay is not energized. In either case, applying electrical current to the contacts will change their state. Relays are generally used to switch smaller currents in a control circuit and do not usually control power consuming devices except for small motors and Solenoids that draw low amps. Nonetheless, relays can "control" larger voltages and amperes by having an amplifying effect because a small voltage applied to a relays coil can result in a large voltage being switched by the contacts. Protective relays can prevent equipment damage by detecting electrical abnormalities, including overcurrent, undercurrent, overloads and reverse currents. In addition, relays are also widely used to switch starting coils, heating elements, pilot lights and audible alarms.

3.3.2.2 Component 2 : Servomotor

A servomotor is a rotary actuator or linear actuator that allows for precise control of angular or linear position, velocity and acceleration. It consists of a suitable motor coupled to a sensor for position feedback. It also requires a relatively sophisticated controller, often a dedicated module designed specifically for use with servomotors.

3.3.2.3 Component 3 : Step Down Transformer

A step down transformer is a type of transformer, which converts a high voltage at the primary side to a low voltage at the secondary side. If we speak in terms of the coil windings, the primary winding of Step Down Transformer has more turns than the secondary winding.

3.3.2.4 Component 4:Adapter

An adapter or adaptor is a device that converts attributes of one device or system to those of an otherwise incompatible device or system. An adapter is a physical device that allows one hardware or electronic interface to be adapted (accommodated without loss of function) to another hardware or electronic interface.

3.3.3 Circuit Operation

When the power supply is fed to the NODEMCU, first it will go through a step-down transformer. This is because the operating voltage of NODEMCU is 3.3V, which means when the voltage is more than 3.3V it will cause the NodeMCU to burn. From the NODEMCU, the relay or servomotor depends on the command given.

3.4 Project Software

Software that is used during this project is Telegram Apps for Smartphone. Telegram is a platform with iOS and Android apps to control Arduino, Raspberry Pi and the like over the Internet. From here we can give a command either to control the lamp or door by giving a command through Telegram. Here is the command that has been given through the Telegram application:

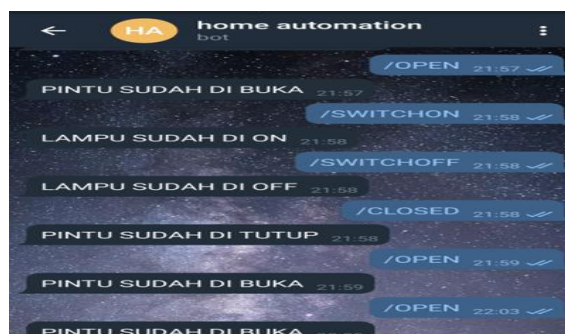

Figure 3. 4: Command that has been given through Telegram Apps

3.5 Prototype Development

For prototype development, we have completed some of these projects by doing a mini-project. The mini-project includes relay and servo motor. The prototype development of the project is shown below :

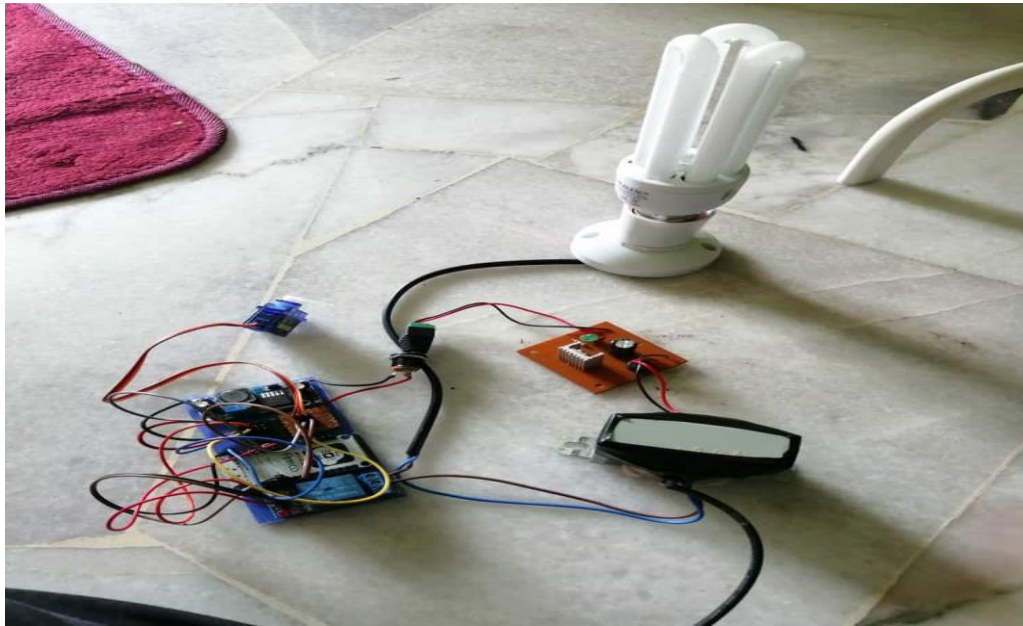

Figure 3. 5: Circuit of Prototype Development

3.5.1 Mechanical Design/Product Layout

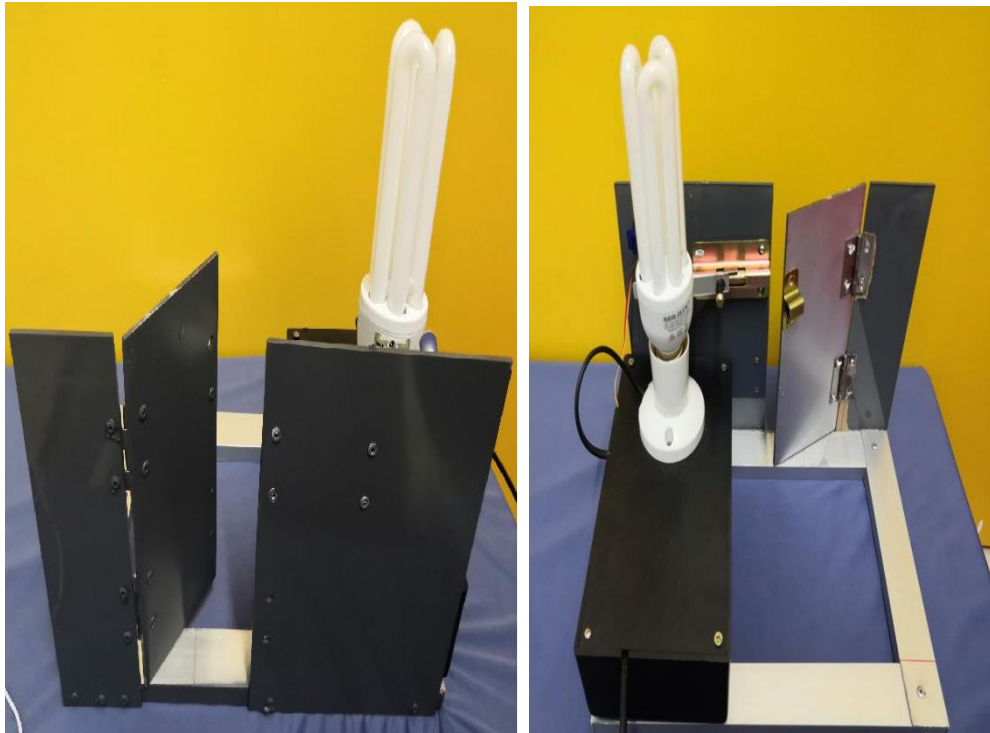

Figure 3. 5.1: Front and back view of the project

3.6 Sustainability Element in The Design Concept

The design show that the wiring component is in the small box, so it is more neat.Plus the design is not too big and it can be carry by using a bag so it very covenient

3.7 Chapter Summary

So this chapter is discuss about the project design and overview such as flowchart of the project and also the block diagram of the project. Besides, this chapter also discuss about the component that is being used in this project.

CHAPTER 4

RESULTS AND DISCUSSION

4.1 Introduction

To find out more about the results, testing and running the whole process of the project have been made. The purpose is also to observe the performance and how well the project works.

4.2 Results and Analysis

As for the result this project is manage to control light and door using a smartphone. Telegram is a platform to give a command either to control the lamp or door.

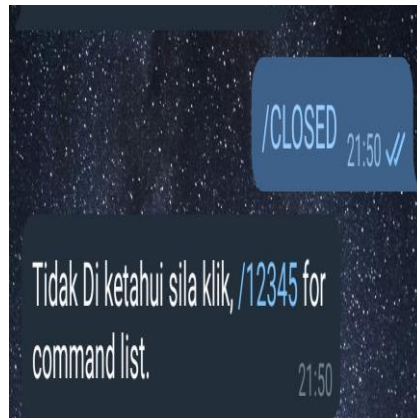

This happened when we are enter the wrong command. It supposedly to enter /12345 first before we are going to give the command.



This is happened when we gve a command through telegram. After the project make a movement then telegram wil notify us like show in a diagram above.



This will happen when we are giving more than one command at the same time. The message that Telegram notifies us are not the same as the action that is taken by the project. The solution is we need to clear the conversation and start all over again.

4.3 Discussion

Basically in this project will make a movement based on the command that has been given. If we want to control light or door just insert the command either want to control the door or lamp by open or closed the light or door. Only one command that can be done in one time. After giving a command then the Telegram will give notification to us based on the command given. The action taken after the command is given is based on how fast our connection is. If the connection is good then the Telegram will respond on time meanwhile if the connection is poor, we need to wait for awhile until the notification is pop out at the Telegram. This project limit range is within 28m range to give a command.

4.4 Chapter Summary

There are two sections in this chapter, the first section is discuss about the type of refrigerator that has been used to test the project. The second section discuss about testing and running the whole process of the project and also observing what happens to the software and the hardware part if the temperature exceeds the set value in the code program.

CHAPTER 5

CONCLUSION AND RECOMMENDATIONS

5.1 Introduction

To summarize the overall results, the conclusion must be drawn in order to see the benefits of the project and also to improve the project to its fullest potential.

5.2 Conclusion

Nowadays, technologies is growing rapidly and it is same goes to the home automation. As for this project it highly recommended for everyone in this world especially for a user who is with disabilities and for the householder too. This recommendation will lead to a green world which is it can help to save and reduce on electricity bills. Plus, it will help and lead the diasabilities person can work independantly and help them to manage their house safety in more organized way. It will help to prevent any loss to a user or unwanted circumstances to a user.

5.3 Suggestion for Future Work

The project is expected to perform extensive testing and also suggested to upgrade the temperature sensor to the wireless mode without using any connection of a cable. This project also will improve its functionality for widely usage other than monitoring the refrigerators such as monitor the server room temperature or monitor the home appliances.

5.4 Chapter Summary

This chapter discuss about the significance of the project and also discuss about the future work suggestion to increase its functionality for widely usage.

CHAPTER 6

PROJECT MANAGEMENT AND COSTING

6.1 Introduction

In this chapter, we are more focusing more to costing and management which is the cost and budget and the cost that is being used and calculated in this project and the time taken is taken to complete all the assesment that is needed in this project in gantt chart plus to cleared see the process it can be seen in milestone section. There the costing and the time taken will be shown in milestone .

6.2 Gant Chart and Activities of the Project

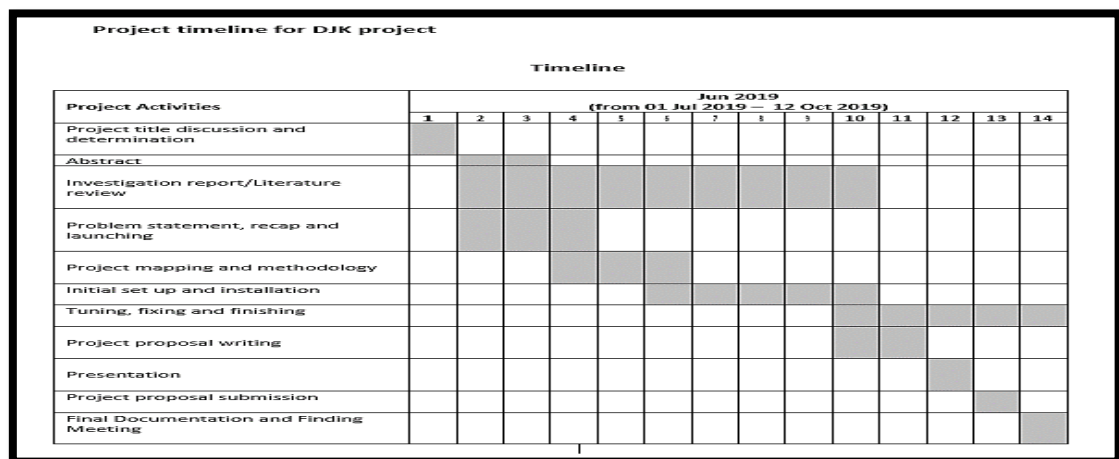

Table 6. 1: Gant Chart for Project 1 in Semester 4

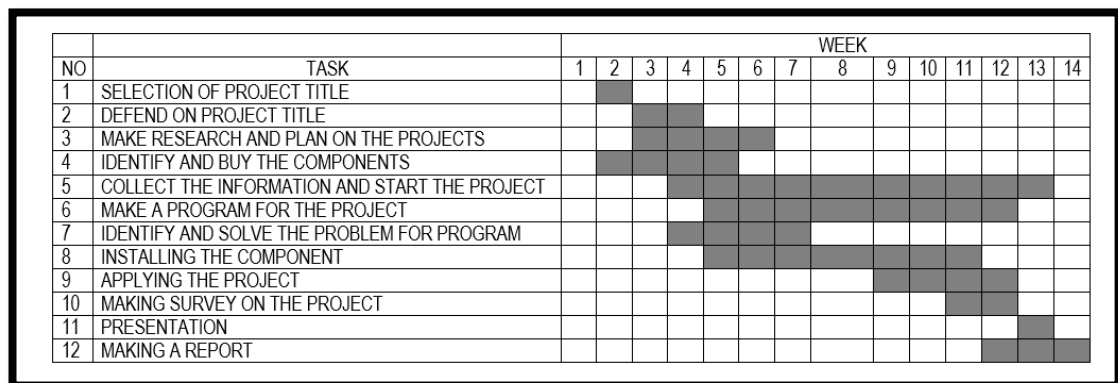

Table 6. 2: Gant Chart for Project 2 in Semester 5

6.3 Milestone

Course	No	Task Name	Implementation	Duration (Days)	Cost (RM)
DEE40082 PROJECT 1	1	HOME AUTOMATION BASED ON IOT.	Plan	98	73.00
			Actual		93.00
	2	START	Plan	0 days	0.00
			Actual		
	3	INVESTIGATION REPORT	Plan	49	0.00
			Actual	56	0.00
	4	FIND INFORMATION ABOUT A PROJECT THAT RELATED TO INDUSTRY AND IR 4.0	Plan	7	0.00
			Actual	14	0.00
	5	PRESENT 3 SELECTED PROJECTS TO LECTURER	Plan	21	0.00
			Actual	28	0.00
	6	SEARCH ONLINE THE LITERATURE REVIEW	Plan	28	0.00
			Actual	35	0.00
	7	DRAW A FLOWCHART OF PROJECT FLOW	Plan	42	0.00
			Actual	42	0.00
	8	DRAW THE SCHEMATIC CIRCUIT OF THE PROJECT	Plan	7	0.00
			Actual	14	0.00
	9	PREPARE AND SUBMIT THE INVESTIGATION REPORT	Plan	7	0.00
			Actual	14	0.00
	10	PROJECT PROGRESS(DESIGN,FABRICATE,INSTALL,TESTING)	Plan	49	73.00
			Actual	49	93.00
11	PURCHASE COMPONENTS AND MATERIALS	Plan	14	100.00	
		Actual	14	115.00	
12	CONSTRUCT GRAPHICS/ TABLES/ DIAGRAM FLOWCHART/ALGORITHM/PROGRAMMING/CODING	Plan	14	0.00	
		Actual	21	0.00	
13	PRODUCE CIRCUIT SCHEMATIC AND CIRCUIT SEMULATION	Plan	14	0.00	
		Actual	21	0.00	
14	PRODUCE PCB DESIGN LAYOUT	Plan	7	0.00	
		Actual	14	0.00	
15	PRODUCE PCB USING ETCHING OR CNC MILLING	Plan	7	0.00	
		Actual	7	0.00	
16	SOLDERING TOOLS AND TECHNIQUE	Plan	7	0.00	
		Actual	14	0.00	
17	COMPONENT AND CIRCUIT TESTING	Plan	21	0.00	
		Actual	21	0.00	
18	DOCUMENT WRITING REPORT(FINAL PROPOSAL& LOGBOOK)	Plan	91	0.00	
		Actual	91	0.00	
19	WRITING THE FINAL PROPOSAL	Plan	42	0.00	
		Actual	42	0.00	
20	WRITING THE LOGBOOK	Plan	70	0.00	
		Actual	77	0.00	

Table 6. 3: Milestone for Project 1 in Semester 4

Course	21	Task Name	Implementation	Duration (Days)	Cost (RM)
DEE50102 PROJECT 2		HOME AUTOMATION BASED ON IOT.	Plan	98	495.00
			Actual		543.00
	22	INSTALLATION	Plan	84	475.00
			Actual	84	510.00
	23	INSTALLATION OF COMPONENTS ON PCB	Plan	35	25.00
			Actual	42	50.00
	24	INSTALLATION OF WIRING	Plan	28	70.00
			Actual	35	15.00
	25	INSTALLATION OF SOFTWARE	Plan	35	30.00
			Actual	48	60.00
	26	INSTALLATION OF CONTROL CIRCUIT / SYSTEM	Plan	42	150.00
			Actual	42	155.00
	27	INSTALLATION OF PROJECT CASING	Plan	28	200.00
			Actual	35	230.00
	28	TESTING	Plan	91	20.00
			Actual	91	33.00
	29	TEST THE ELECTRONIC PART	Plan	35	0.00
			Actual	42	0.00
	30	TEST THE MECHANICAL PART	Plan	28	20.00
			Actual	35	33.00
	31	TEST THE OVERALL PROCESS / PROJECT	Plan	28	0.00
			Actual	35	0.00
	32	DOCUMENTS	Plan	98	0.00
			Actual	98	0.00
	33	PREPARATION OF SLIDE PRESENTATION	Plan	28	10.00
			Actual	35	15.00
	34	PREPARATION OF LOGBOOK	Plan	98	0.00
			Actual	105	0.00
	35	PREPARATION OF PROJECT 2 FINAL REPORT	Plan	98	30.00
			Actual	98	50.00
	36	PREPARATION OF INSTRUCTION MANUAL	Plan	42	20.00
			Actual	49	25.00
	37	END	Plan	7	0.00
			Actual	7	0.00

Table 6. 4: Milestone for Project 2 in Semester 5

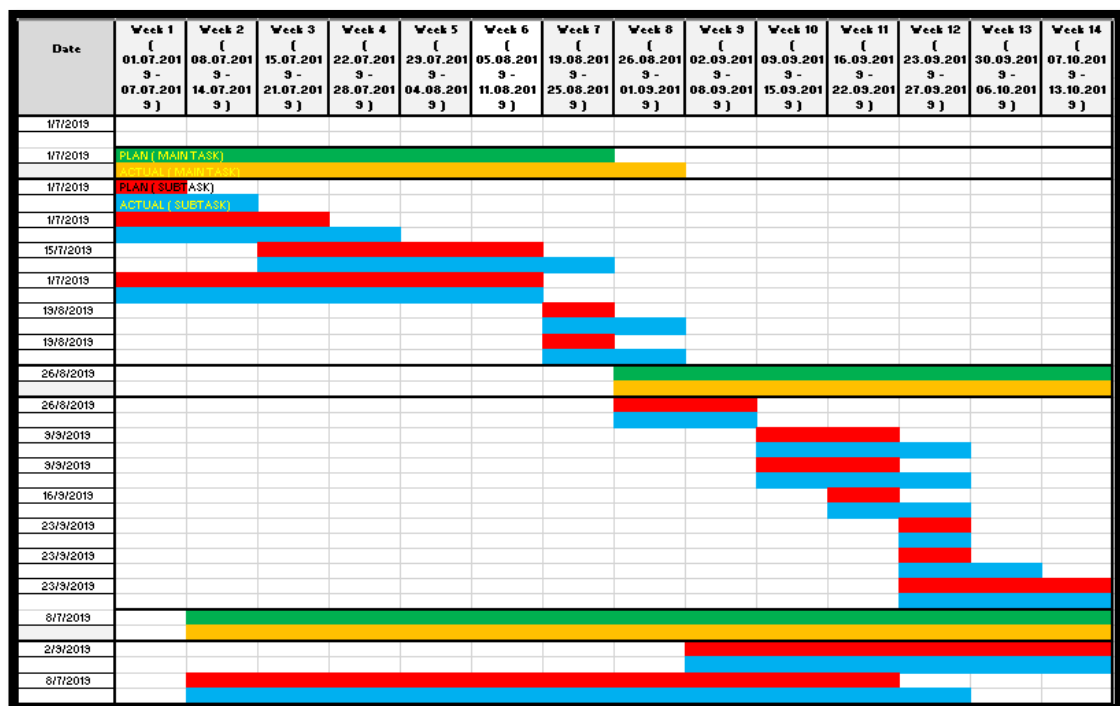

Table 6. 5: Milestone Bar for Project 1 in Semester 4

Date	Week 1	Week 2	Week 3	Week 4	Week 5	Week 6	Week 7	Week 8	Week 9	Week 10	Week 11	Week 12	Week 13	Week 14
	(09.12.2019 - 15.12.2019)	(16.12.2019 - 22.12.2019)	(30.12.2019 - 05.01.2020)	(06.01.2020 - 12.01.2020)	(13.01.2020 - 19.01.2020)	(20.01.2020 - 26.01.2020)	(03.02.2020 - 09.02.2020)	(10.02.2020 - 16.02.2020)	(17.02.2020 - 23.02.2020)	(24.02.2020 - 01.03.2020)	(02.03.2020 - 08.03.2020)	(09.03.2020 - 15.03.2020)	(16.03.2020 - 22.03.2020)	(23.03.2020 - 29.03.2020)
9/12/2019	[Green bar]													
9/12/2019	[Yellow bar]													
23/12/2019	[Red bar]													
23/12/2019	[Blue bar]													
19/1/2020	[Red bar]													
2/2/2020	[Blue bar]													
9/12/2019	[Green bar]													
22/12/2019	[Yellow bar]													
29/12/2019	[Red bar]													
2/2/2020	[Blue bar]													
9/12/2019	[Green bar]													
2/2/2020	[Yellow bar]													
8/12/2019	[Red bar]													
8/12/2019	[Blue bar]													
9/2/2020	[Red bar]													
26/3/2019	[Blue bar]													

Table 6. 6: Milestone Bar for Project 2 in Semester 5

6.4 Cost and Budget

No.	Component	Cost	Quantity	Total
1	Battery 9v	RM 4.00	1	RM 4.00
2	Battery holder	RM 1.00	1	RM 1.00
3	Breadboard	RM 6.00	1	RM 6.00
4	Stripboard	RM 3.00	1	RM 3.00
5	LED	RM 0.30	1	RM 0.30
6	Solder	RM 33.00	1	RM 33.00
7	Sucker	RM 11.50	1	RM 11.50
8	Jumper wire	RM 3.00	3	RM 9.00
9	Lamp&lamp holder	RM 7.00	1	RM 7.00
10	Lead	RM 3.00	1	RM 3.00
11	Resistor	RM 0.60	1	RM 0.60
12	Push button	RM 2.00	2	RM 4.00
13	Bulb	RM 9.00	1	RM 9.00
14	Bulb holder	RM 2.50	1	RM 2.50
16	Transformer	RM 18.00	1	RM 18.00
			TOTAL	RM111.90

Cost Estimation Project Table 6. 7: Cost Estimation Project

6.4 Chapter Summary

So this chapter shows about the budget cost that have being used in this project , the activities that had been done since week 1 to week 14 in Semester 4 and recently in Semester 5 from week 1 to week 14.

REFERENCES

- 1 Teymourzadeh, Rozita, et al. "Smart GSM Based Home Automation System." *Systems, Process & Control (ICSPC), 2013 IEEE Conference on*. IEEE, 2013.
- 2 Singh, Navab, et al. "Remotely controlled home automation system." *Advances in Engineering and Technology Research (ICAETR), 2014 International Conference on*. IEEE, 2014.
- 3 PavithraD,IoT based Monitoring and Control System for Home Automation,Proceedings of 2015 Global Conference on Communication Technologies(GCCT 2015)
- 4 Wenbo, Yan, Wang Quanyu, and GaoZhenwei. "Smart home implementation based on Internet and WiFi technology." *Control Conference (CCC), 2015 34th Chinese*. IEEE, 2015.
- 5 Gurek, Alper, et al. "An android based home automation system." *High Capacity Optical Networks and Enabling Technologies (HONET-CNS), 2013 10th International Conference on*. IEEE, 2013.

APPENDICES

APPENDIX A- DATA SHEET

APPENDIX B- PROGRAMMING

APPENDIX C- PROJECT MANUAL/PRODUCT CATALOGUE

